

sportfish

A stylized graphic element consisting of a white swoosh that curves upwards and then downwards into a lime green shape, resembling a fish tail or a dynamic arrow.

www.sportfish.co.uk

Spring/Summer 2023
Catalogue prices valid until 31st August 2023

WELCOME TO THE SPRING 2023 SPORTFISH CATALOGUE

You may remember the Sportfish mission from our previous catalogue. Part of it is about striving to give you an amazing customer experience, plus friendly advice & tuition for every level of angler.

Another part of it is about offering the ultimate range of quality game fishing products to suit every budget. A ridiculous amount of time and testing dictates which products make it into this catalogue, and which don't. We're obsessives, fanatics, gear junkies. It's not all about the best of the best though. This catalogue is a book of dreams for every fly fisher. We sell fishing rods for under £80 and for over £1,000. The 8,000+ products in this catalogue are there because they're the best quality for the price. We've done the hard work (and the late nights) to make your choices a little easier, so you can shop with confidence, knowing that quality is guaranteed, whatever your budget. Perhaps more important now than it's ever been.

Even in uncertain, challenging times anglers generally remain an optimistic, even philosophical bunch. Fishing author John Gierach summed it up nicely when he wrote "they say you forget your troubles on a trout stream, but that's not quite it. What happens is that you begin to see where your troubles fit into the grand scheme of things, and suddenly they're just not such a big deal anymore." It's one of the myriad reasons we continue to fish, and it was a pretty mixed season for many of us last year. As always though, the anticipation of a new season ahead of us and all the possibilities it might bring has kept us going in the long dark, cold wet months. Finally, it's here, and there's lots to be excited about.

As always we have lots of new products for you, some of which are highlighted here. New fly rods include the outstanding extension to the award-winning Sage R8 fly rod family the Sage Salt R8 (p12), the 2nd generation Mackenzie FX2 range (p24) and the Guideline NT11 family (p28). There are some superb new saltwater reel families with the Sage Enforcer (p38) and the Lamson Centerfire (p41), plus a revolutionary Simms G4 Pro Powerlock wading boot with its interchangeable cleats (p112). The women's wading collection from Simms includes two new waders and a wading jacket (p115). You can build your own C&F fly boxes to your choice of size, colour and format (p95) and we've got a completely new range of great value polarised sunglasses from UK brand Fortis Eyewear (p178). Loon's innovative new tools and accessories include pliers (p153),

amadou (p154) and a fly tying mat you can't do without (p184). And don't miss double World Champion Howard Croston's Drop Back Bung system and flies (p85).

We believe that as a company we are responsible for achieving the highest standards of environmental practice and for operating in a sustainable manner. Our catalogue is printed using FSC® (Forest Stewardship Council) certified paper and mailed out in a recyclable FSC® certified wrap. Sportfish is a Planet Mark certified Business, meaning we are committed to reducing our carbon emissions by 5% annually. We continue to actively support a host of UK charities and organisations promoting the protection of our fish and waters and will be making even greater efforts around both the sustainability of our business itself and fish conservation throughout the year.

Our team is as passionate about the sport as you are, and they love nothing better than applying their knowledge and expertise to make your fishing the best it can be. Whether that's talking you through the latest kit, providing tips and techniques to up your game, welcoming you for some tuition on our lakes or trying out a rod or two on our casting pool, we've got you covered. Just give us a call.

Enjoy the catalogue and let's get you ready for a cracking new season.

Best wishes and tight lines.

The Sportfish Team.

BY THOSE WHO FISH, FOR THOSE WHO FISH.

Proud To Support:



WILD TROUT TRUST



Reducing Our Carbon Footprint:



PlanetMark
Certified Business



SHOP WITH CONFIDENCE

We at Sportfish are driven to provide you with the best value when you shop with us on the telephone, online or in our stores. If you see an identical product, including colour and size variations, advertised for less with another retailer in a current promotion and we have it in stock, we will match the price or refund the difference. We can only do this if you bring this to our attention either prior to or within 7 days of purchase and provide us with a copy of the relevant advert or web link.

We reserve the right to satisfy ourselves that the offer is made by a UK based retailer of similar standing to Sportfish and that they offer reasonable levels of customer service and operate at least one retail store.



COMPREHENSIVE GUARANTEE

All of your purchases are covered by our comprehensive guarantee. In the unlikely event of a problem with your purchase, please do not hesitate to contact us. We will do our best to put things right straight away for you. We will gladly exchange or refund your unused purchase if you return it within 28 days of receipt. This is in addition to your statutory rights.

3 EASY WAYS TO BUY

1 Shop Online

www.sportfish.co.uk

2 Call our Orderline

01544 327 111

(Calls may be recorded for training purposes)

3 Visit Our Stores

Winforton

Hereford HR3 6SP

T: 01544 327 111 E: sportfish@sportfish.co.uk

Sportfish Game Fishing Centre

Theale, Reading RG7 4AS

T: 0118 930 3860 E: sportfish-reading@sportfish.co.uk

Farlows

9 Pall Mall, London SW1Y 5NP

T: 020 7484 1000 E: fishing@farlows.co.uk

CONTENTS

SPORTFISH OUTFITS	2-5
FLY RODS	6-33
FLY REELS	34-53
FLY LINES	54-71
LEADERS & TIPPETS	72-78
FLIES	79-94
FLY BOXES	95-100
WADING	101-123
CLOTHING	124-150
ACCESSORIES	151-161
NETS	162-165
BAGS	166-175
SUNGLASSES	176-180
FLY TYING	181-202
BOOKS & DVDS	203-204
LURE FISHING	205-219
WINFORTON STORE & MAILORDER	220
TRADE-IN/ SOCIAL MEDIA	221
GAME FISHING CENTRE	222
OUR FISHING	223
SHOP WITH CONFIDENCE	224
INDEX	225



All efforts have been made to ensure accuracy in the preparation of this catalogue, but inevitably errors and omissions may occur, and specifications or supply may change. Sportfish cannot be held responsible for such errors and omissions, but we will endeavour to put notice of such on our website upon discovery.

Front cover photo by Matt Harris, sunset at Draycote. See Matt's latest book on page 204.

Inside front cover photo by Sebastian Pecchia, boat on Chew Valley Lake.



Our catalogue is printed using FSC® (Forest Stewardship Council®) certified paper and is mailed out in a recyclable FSC® certified wrap.

Sportfish Recommends...

River Fishing Essentials

Apart from a rod, reel and line, there are plenty of other bits of kit you'll need when you first venture out onto the water. It's important to protect your eyes when casting, to wear appropriate clothing to protect you from the elements and to carry a range of tackle items to help you make the most of your day. For those looking to kit themselves out on a budget, we've put together our recommended river fishing outfits, designed to ensure you're fully equipped without breaking the bank.

1 Vision Atom Waders

Code 20A0055 £199.99

– See page 108

2 Englands Survivor Life Jacket

Code 27738 £89.99

– See page 161

3 Snowbee Prestige² Wading Jacket

Code 18A0083 £199.99

– See page 133

4 Vision Atom Boots

Code 20B0023 from £109.99

– See page 114

5 Fortis Wraps Sunglasses

Code 23A0071 from £24.99

– See page 178

6 Sage Chasing Trout Cap

Code 23A0055 £29.99

– See page 149

7 Wychwood Drift Rods

Code 17A0003 from £129.99

– See page 29

8 Snowbee Classic² Reels

Code 20A0049 from £39.99

– See page 46

9 Wychwood Feather Floater Fly Line

Code 16A0066 £39.99

– See page 58

10 Leeda Profil Fly Boxes

Code 11A0282 £7.99

– See page 98

11 Snowbee Prestige Trout Bags

Code 11A0124/11A0125 from £32.99

– See page 166

12 Wooden Landing Net

Code 16B0034 £32.99

– See page 165

13 "Must Have" Dry Flies

Code 155020 £13.50

– See page 93



Sportfish Recommends...

Stillwater Fishing Essentials

Apart from a rod, reel and line, there are plenty of other bits of kit you'll need when you first venture out onto the water. It's important to protect your eyes when casting, to wear appropriate clothing to protect you from the elements and to carry a range of tackle items to help you make the most of your day. For those looking to kit themselves out on a budget, we've put together our recommended stillwater fishing outfits, designed to ensure you're fully equipped without breaking the bank.

1 Vision Atom Jacket
Code 21A0071 £139.99
 – See page 132

2 Snowbee Granite PVC Thigh Waders
Code 17A0027 £54.99
 – See page 117

3 Snowbee Classic Fly Vest
Code 13A0086 from £59.99
 – See page 146

4 Fortis Bays Life Sunglasses
Code 23A0063 from £34.99
 – See page 178

5 Abu Garcia Cap
Code 20B0066 £12.99
 – See page 149

6 Greys Lance Rods
Code 22B0013 from £139.99
 – See page 20

7 Greys Fin Reels
Code 21B0032 from £62.99
 – See page 44

8 Airflo Superflo Stillwater Fly Line
Code 21A0096 £69.99
 – See page 56

9 Greys GS Water Resistant Fly Box
Code 14A0162 £16.99
 – See page 98

10 Wychwood Flow Carryall Bag
Code 12A0247 from £54.99
 – See page 166

11 ABU Folding Net
Code 15A0431 £42.99
 – See page 165

12 "Must Have"
 Golden Nuggets Flies
Code 155080 £13.50
 – See page 93



READY TO FISH OUTFITS

Selecting your first fly fishing outfit can seem like a challenge, particularly as there are so many options out there - all designed for different fishing situations. Where do you start?

Luckily, our range of ready-to-fish kits include all you'll need to get out onto the water and start catching fish! Whether your chosen path is trout fishing on rivers, stillwaters or reservoirs our kits have you covered. Grab them and go fishing!

Ready-to-fish outfits have been gaining in popularity recently, not just for beginners looking for their first fly fishing setup, but also for more experienced fishers looking to add another weapon to their arsenal. When you buy one of our kits from Greys, you can be confident that the rod, reel and fly line are all in perfect balance. Grab one and get fishing!



Greys Fin Combination Outfits

The all-new Greys Fin combination outfits cover everything from small stream trout to large reservoirs. These ready-to-fish outfits feature a Greys Fin fly reel, a high-performance fast action 4-piece Greys Fin fly rod and a fully fitted twin colour floating line complete with backing and a tapered leader. The outfit is supplied in a secure zipped rod & reel travel case.

Code 22B0011

Length	Line	Handle	Sections	Price
8'0"	#4	A	4	£179.99
9'0"	#5	A	4	£189.99
9'0"	#6	A	4	£189.99
9'0"	#8	B	4	£189.99
10'0"	#7	B	4	£219.99



Greys K4ST Combination Outfits

A superb value for money outfit that will get you started on your fly fishing journey. The K4ST outfit consists of a high quality medium-action Greys rod and reel fitted with a Greys weight forward (WF) floating fly line, backing and leader all supplied together in a handy travel case.

Code 20B0019

Length	Line	Sections	Price
8'0"	#4	4	£84.99
9'0"	#5	4	£84.99
9'6"	#7	4	£89.99
10'0"	#7	4	£94.99



Greys K4ST+ Combination Outfits

The Greys K4ST+ outfit is an upgraded version of the K4ST outfit with a slightly faster actioned Greys rod and an aluminium reel fitted with a Greys weight forward (WF) floating fly line, backing and leader all supplied together in a handy travel case.

Code 20B0020

Length	Line	Sections	Price
7'0"	#3	4	£99.99
9'0"	#5	4	£109.99
9'0"	#6	4	£109.99
9'0"	#8	4	£119.99
9'6"	#7	4	£129.99
10'0"	#7	4	£139.99



Greys K4STX Combination Outfits

The Greys K4STX outfit is an upgraded version of the K4ST+ outfit with a faster actioned Greys rod and an aluminium large arbor reel fitted with a Greys twin coloured weight forward (WF) floating fly line, backing and leader all supplied together in a handy travel case. The Euro Nymph outfit is supplied with a unique Euro Nymph fly line with in-built leader and tippet ring.

Code 20B0021

Length	Line	Sections	Price
8'0"	#4	4	£159.99
9'0"	#5	4	£159.99
9'0"	#6	4	£159.99
9'0" Predator	#9	4	£169.99
9'6"	#7	4	£169.99
10'0" ESN	#3	4	£169.99



FROM
£139.⁹⁹

Snowbee Classic Combo Outfits

The Snowbee Classic Combo Kits offer amazing value for money for a quality 4-piece fly rod, reel and line kit, ready to start you fishing.

Key Features

- A 4-piece Snowbee Classic fly rod – a high modulus, lightweight graphite fly rod, with an easy action for effortless casting
- High-lift snake guides, A-grade cork handle, lightweight graphite reel seat and a quality cloth rod bag
- Lightweight graphite fly reel with offset drag, pre-loaded with backing, fly line and leader
- Quality Snowbee Classic floating fly line in weight-forward profile

Code 19A0049

Length	Line	Sections	Weight (oz)	Price
7'0"	#4	4	2.9	£139.99
7'0" Junior	#6	4	3.2	£144.99
8'6"	#5	4	3.6	£154.99
9'0"	#5	4	3.7	£154.99
9'0"	#6	4	3.8	£154.99
9'0" Salt	#8	4	3.9	£174.99
9'6"	#7	4	4.4	£169.99
10'0"	#7	4	4.6	£174.99



ORVIS

FROM
£209.⁰⁰



Orvis Encounter® Fly Fishing Outfits

The Orvis Encounter® rod, reel and line outfits offer fantastic value and are perfect for anglers of all ages just starting out in fly fishing. These balanced outfits are built to Orvis' exacting specifications and are designed to make fly casting as easy as possible. Just add a fly and you're ready to go fly fishing.

Key Features

- 4-piece Orvis Encounter® rod
- Matching Orvis large arbor Encounter® fly reel
- Reel loaded with an Orvis floating fly line, backing and tapered leader
- Supplied in a convenient and protective rod and reel carrier

Code 22A0018

Length	Line	Sections	Price
8'6"	#5	4	£209.00
9'0"	#5	4	£209.00
9'0"	#6	4	£209.00
9'0"	#8	4	£209.00
9'6"	#6	4	£209.00



REDINGTON

FROM
£199.⁹⁹

Redington MINNOW Outfit

The perfect outfit for young anglers, built with enough power to throw a wide variety of flies. The shorter 8ft length offers less weight and with its medium action makes it easier for younger casters. The outfit includes a Redington MINNOW rod, matching Redington CROSSWATER reel pre-spooled with a matching RIO Mainstream WF5 fly line with backing and leader. Just add a fly and off you go.

Key Features

- Funky camo handle
- Bright green blank
- Easy casting medium action
- Shorter rod length makes it easy for younger anglers
- Alignment dots on each section
- Supplied with a cordura rod & reel tube

Code 19A0078

Length	Line	Sections	Weight (oz)	Price
8'0"	#5	4	3.6	£199.99



SAGE

WAS
FROM £799.47
NOW
£699.00

Sage FOUNDATION "Ready-to-Fish" Outfits

The Sage FOUNDATION is also available as a ready-to-fish outfit supplied with matching Sage SPECTRUM C series fly reel, RIO Gold fly line, RIO backing and a RIO Powerflex tapered leader. The Sage FOUNDATION outfit is supplied complete in a convenient rugged cordura case with a built in reel pouch. This great value outfit offers a saving of up to £100.47.

Code 17B0005

Length	Line	Sections	Handle	Wt.(oz)	Was	Price
9'0"	#4	4	B	2.8	£779.47	£699.00
9'0"	#5	4	B	3.0	£779.47	£699.00
9'0"	#6	4	B	3.2	£779.47	£699.00
9'0"	#8	4	C	3.8	£799.47	£699.00



CHARLES JARDINE

Director of Fishing for Schools, author and USA Fly Fishing Hall of Fame's only living UK inductee.

PURCHASING A SINGLE-HANDED FLY ROD

They seduce, they are shiny, they glisten with *come buy me allure...* they are new fly rods.

No matter how long you have been fishing, whatever discipline or, indeed, area of the sport or experience... there is something beguiling about a new rod. Dreams, imagined adventures to come and excitement are entwined with every waggle, flex and touch. Beware. Is it the right rod for you?

The perfect place to start is with a built-in guarantee of some sort. There are a good many dodgy deals out there... the internet is quicksand for the naïve. Be guided by your pocket, product reputation and knowledgeable help and forsake any deals that look to be too good to be true: invariably they are. Go with practical knowledge - irrespective of where you are in the sport. Ask someone who knows, like the team at Sportfish.

Purchasing a single-handed fly rod is almost as angst ridden and loaded with nervous excitement and self-doubt as buying a home or a car, arguably worse. Why? Dreams, aspirations and hopes are bound up in that leap into the unknown and what doesn't help is that there are few bad rods out there. Most are serviceable, many are impressive.

So, where does one start? Three things should guide you:

- 1. The best you can afford**
- 2. Application for primary task**
- 3. You actually like it**

Set yourself a price that you can comfortably afford. You will probably want to add a line and reel with the purchase, too, so work within a budget. The overriding element is what you want the rod to do. Let that be your guide. It is no use trying and falling in love with a beautiful rod that is hopelessly ill-suited to the waters you fish.

There are, of course, fly rods that cross the divide; a medium-to-fast action (see my action guide below) 9' #5 or #6 rod will carry you around the world and embrace many species including trout, sea trout, mullet, bass the odd Icelandic salmon (if you are fortunate), bonefish and a myriad of smaller sporting species.

My view remains that you should try a variety and let your hands and wallet determine your decision - but TRY THEM. Ask a knowledgeable sales assistant - the Sportfish team are brilliant: they fish and they know their fly rods.

So, here's a quick overview:

River Rods

Small rivers and brooks

6'6" to 8' rods in the #2-4 weight line category. Try lines with rods, you may feel that a #2 rod is best loaded for short casting with a #3 line.

Medium to large rivers

On chalk streams and freestone rivers such as the Wharfe, Usk and Clyde etc. Choose an 8'6" as a minimum, even extending to the more specialist 10' #3-5, which is great for nymphing and classic wet fly fishing.

Mayfly

Rivers are popular during this period and many anglers prepare for this one occasion only, but turning over a big, bushy mayfly is NOT the place for delicate #2 fly rods. A 9' #4 is better and a #5 will do a good job.

Lake Rods

Small stillwaters

You can get by with the shorter style of rod for stalking and clear water use - a 9' #5-6 is perfect so it can double as a river rod, too or you can use the longer rods - the 10' #6/7. But, you MUST consider where you are going to fish and the style of fishing. There is no point trying to get a 9' #5 to propel a heavy, sinking line and a booby - it can be done, but might be a struggle.

Big Reservoirs

Friends fish reservoirs on the bank very effectively with a 9' #5/#6. Would it be my first choice? No. Far better to use a 10' #6 or 7 that will work well from the shore AND the boat. Let's not forget the oft overlooked 9'6" for #6 or #7 it's a great length of rod and huge fun. Many prefer a 10' #8 for the sheer ability to 'ping out' a long line towards the horizon but remember the heavier you go the less fun you will probably have. It's your choice and of course, by selecting from the last mentioned rods you have something very serviceable for sea trout and light salmon. Win-win.

If it's fun to use, meets the criteria that you want from a fly rod and puts a smile on your face after a few casts with the right line, then it's job done - as long as it's within budget.



JIM FEARN

Guide Fly Fishing (UK distributors for Sage, RIO, Vision, Redington, Fishpond, Mclean)

CHOOSING A DOUBLE HANDED FLY ROD

Part of my job is to advise on fly fishing equipment and, perhaps not surprisingly, the question I'm most often asked is: "What fly rod do I need?"

Asking what salmon rod you should buy is like asking how long your leader should be, there is no single answer for every situation. Thankfully, one salmon rod can cover more than one situation – but not all of them – and having the wrong tool for a given job can be a painful experience.

Price aside, the main questions to ask yourself are where and when you will be fishing, as the size of river and time of year will dictate the size of flies and type of lines you will be using. Let's start at the beginning of the season, on a big, early spring river. In these conditions you require a rod that:

- Can handle heavy lines/shooting heads/fast tips and turn over large tube flies
- Is capable of long casts in harsh conditions and difficult winds
- Can play fish hard in heavy water without folding
- Can mend line and steer heads (often sinking) at range, to give effective water command

The ideal tool would be a 15' #10 or #11 and my preference would be for a fast action rod capable of delivering high line speed. Such rods have a steely feel and, providing the caster has the necessary technique and room, can wind up a lot of tension during the cast to fire line a long way, even in gale conditions.

A smaller rod, such as a switch rod between 11ft and 12ft, would be a severe disadvantage in these conditions but they offer advantages on smaller summer rivers in low water when you will be fishing lighter line weights.

Switch Rods

- Are less cumbersome and, in conjunction with shorter heads, make drawing flies in slacker pools more effective
- Allow delicate presentation with light line and require less room behind the fisher to make the cast, opening up overgrown or steep-sided river sections
- Are lighter in action and easier to load without much line behind the caster, making it easier to achieve a squarer cast in areas of limited space

The middle ground between the fifteen-footer and the switch would be either a 13' #8/9 or 14' #9/10.

Although only a foot shorter 14-footers feel surprisingly light in the hands compared to 15-footers. This length of rod has been gaining popularity in recent years, mostly down to advances in the line systems that are now available. Lines such as shorter shooting heads and Skagit's enable large flies and fast tips to be cast much more easily than in the old days of full sinking lines (the preserve of 15-footers).

A 14-foot rod is great for floating line work on big/medium rivers and it's not hard to see why they are considered the new all-rounder. However, as with anything termed 'all-round' there is a trade off in certain situations and being a foot shorter they are compromised in lifting heavy lines and turn over compared to 15-foot rods.

13-foot #8 or #9 rods are the preserve of smaller/mid-size rivers or, for my own part, floating/sink tip work with smaller flies on low water big rivers. But what, you may ask, are the failings of a switch rod in these circumstances? The answer is simply range, add a head wind into the equation and I have been beaten in reaching the required distance.

Finally, I feel it's worth pointing out that some rods are sold as line specific, such as shooting head or Skagit or a Spey line rod. I accept I need to have different lines at my disposal, but I really do not want to take four rods with me every time I go out. Thankfully, many rods can handle many different types of line system, and is a question worth asking when purchasing – the Sportfish team has a comprehensive understanding of all models and casting styles and will be happy to advise you.



“Increased purity of graphite provides even more reactivity and sensitivity, shifting energy further down the blank and into the handle.”



SPORTFISH RECOMMENDED Sage SPECTRUM LT Reels
SEE PAGE 38

Sage R8 CORE Fly Rods (R8 Core Technology)

Designed to enhance the two-way connection from hand to fly and back for greater feel, flow and control.

Increased purity of graphite provides even more reactivity and sensitivity, shifting energy further down the blank and into the handle. This transfer of energy creates a more natural extension of your arm, ultimately resulting in less wasted effort and intuitive reactivity. The new axial fibre formulation behind R8 CORE enables Sage to shape a rod with a stiffer, stronger backbone but a more sensitive tip and more connected feel. Revolutionary material technology and maximum versatility, giving you complete control.

Key Features

- Silver pine blank colour
- Slate thread wraps with graduated white and grey trim
- Fuji ceramic stripper guides with hard chromed snake guides and tip-top
- Black rod bag with new cord lock for quicker, easier and cleaner storage
- Aluminium rod tube with Sage medallion

Code 22A0107

Additional sizes are available please visit www.sportfish.co.uk or call 01544 327111 for more information.

Stunning performance and incredibly lightweight, also throws the tightest of loops, and is extremely accurate. My favourite range of Sage rods.

DANNY R NORTH
Sportfish

ASK THE EXPERTS

Silver pine blank colour

A

B



Black spruce blank colour



C

Flor grade cork handles



Sage X Switch & Double Handed Fly Rods (KonneticHD Technology®)

The Sage X rod's slim, fast action taper built together with Sage's KonneticHD Technology® creates tighter, more efficient loops throughout all ranges of casting styles. Reduced vibration and movement in the blank result in more accurate and efficient casts. The perfect balance between angler, rod, line and fly.

Key Features

- KonneticHD technology®
- Black spruce blank colour
- Dark green thread wraps with metallic grey trim wraps
- Fuji® ceramic stripper guides
- Hard chromed snake guides and tip-top
- Flor grade cork handles
- Laser etched line weight on slide band
- Black rod bag with titanium logo and black spruce model tag
- Evergreen powder coated aluminium rod tube with Sage medallion

Code 16B0005

Sage X Switch Rods						
Length	Line	Sections	Handle	Wt.(oz)	Price	
11'0"	#7	4	C	3.4	£1195.00	
11'0"	#8	4	C	3.6	£1195.00	

Sage X Double Handed Rods						
Length	Line	Sections	Handle	Wt.(oz)	Price	
12'0"	#7	4	C	5.9	£1295.00	
13'0"	#8	4	C	6.7	£1295.00	
14'0"	#9	4	C	8.0	£1295.00	
15'0"	#10	4	C	8.9	£1295.00	

Handle **A**

Premium Flor grade, snub-nose, half-wells cork handle with a sustainable ziricote wood insert with anodised aluminium up-locking reel seat.

Handle **B**

Premium Flor grade full-wells cork handle with a cork/EVA fighting butt and a corrosion-resistant anodised aluminium reel seat with an integrated "hidden" reel seat hook keeper.



FROM
£995.00



KonneticHD
Technology®

Chipotle
blank colour

Juniper
blank
colour

Flor grade cork
handles

A

B

C

D

E

F

Saltwater
proof
gunmetal
anodised
aluminium
up-locking
reel seat



SPORTFISH
RECOMMENDED

Sage ARBOR XL Reels
SEE PAGE 38

Sage IGNITER Fly Rods (KonneticHD Technology®)

If you bring the will, the IGNITER will supply the way.

Strong headwind? Fish at distance? Bulky flies? Heavy sink-tips? The most demanding conditions require a different kind of rod. The Sage IGNITER is tuned to handle the most technical of conditions. Not a rod for the everyday angler, the IGNITER is equipped with a high line speed taper to carry large amounts of line at distance with wind cutting performance. Perfect for streamer fishing with heavy sink tips or covering big water when conditions become difficult.

Key Features

- 4 to 6 weights - cocobolo wood insert with gunmetal anodised aluminium up-locking reel seat
- 6 to 10 weights - saltwater proof gunmetal anodised aluminium up-locking reel seat
- 6 to 10 weights - integrated hidden hook keeper in reel seat
- Flor grade cork handles
- KonneticHD technology®
- Chipotle blank colour
- Cayenne thread wraps with gunmetal trim wraps
- Fuji ceramic stripper guides and hard chromed snake guides
- Laser etched line weight on slide band
- Black rod bag with titanium logo and chipotle colour model tag
- Black powder coated aluminium rod tube with Sage medallion

Code 18B0007

Sage IGNITER Single Handed Rods					
Length	Line	Sections	Handle	Wt.(oz)	Price
9'0"	#4	4	A	2.8	£995.00
9'0"	#5	4	A	2.9	£995.00
9'0"	#6	4	A	3.0	£995.00
9'6"	#6	4	B	3.6	£995.00
10'0"	#7	4	B	3.9	£995.00

Sage IGNITER Saltwater Rods					
Length	Line	Sections	Handle	Wt.(oz)	Price
9'0" SW	#6	4	B	3.1	£995.00
9'0" SW	#7	4	B	3.4	£995.00
9'0" SW	#8	4	B	3.8	£995.00
9'0" SW	#9	4	B	4.0	£995.00
9'0" SW	#10	4	B	4.1	£995.00

Sage IGNITER Switch / Double Handed Rods					
Length	Line	Sections	Handle	Wt.(oz)	Price
11'9"	#7	4	C	5.6	£1195.00
11'9"	#8	4	C	5.9	£1195.00
12'6"	#6	4	C	6.0	£1295.00
12'6"	#7	4	C	6.4	£1295.00
13'6"	#8	4	C	7.4	£1295.00
14'0"	#9	4	C	8.0	£1295.00
14'0" Travel	#9	6-TR	C	8.7	£1495.00
15'0"	#10	4	C	9.1	£1295.00

Sage SONIC Fly Rods

The Sage SONIC family of fly rods provides uncompromised versatility, with a balance of power and feel. Delightfully crisp and lightweight with a fast action taper designed to cover a wide range of fishing applications from dry fly, streamers, to nymphing - floating lines to sinking.

Key Features

- Superlight, responsive KonneticHD Technology®
- Juniper coloured blank
- Fuji ceramic stripper & hard chromed snake guides
- Hardwood inserts and anodised aluminium reel seat
- Integrated "hidden" reel seat hook keeper

Code 21A0002

Length	Line	Sections	Handle	Wt.(oz)	Price
8'6"	#4	4	D	2.6	£749.00
9'0"	#4	4	D	2.6	£749.00
9'0"	#5	4	D	2.7	£749.00
9'0"	#6	4	D	3.0	£749.00
9'6"	#6	4	E	3.6	£749.00
9'6"	#7	4	E	3.9	£749.00
10'0"	#7	4	E	3.9	£749.00
10'0"	#8	4	E	4.0	£749.00
11'6" Switch	#7	4	F	5.6	£849.00
11'6" Switch	#8	4	F	6.0	£849.00
13'6" DH Travel	#7	6	F	7.6	£1049.00
13'6" DH	#8	4	F	7.5	£949.00
14'0" DH Travel	#9	6	F	8.8	£1049.00



“The lightest, most precise casting stream rod ever made.”

Sapling green blank colour

Handcrafted on Bainbridge Island, USA



Ceramic stripper guides and hard chrome snake guides

Konnetic HD Technology®

Floor grade, snub-nosed, half wells cork handles

Vera wood insert with bronze anodised aluminium up-locking reel seat

Black anodised aluminium uplocking reel seat

Walnut wood inserts with bronze up-locking seat

A

B

C

D

Sage DART Fly Rods (KonneticHD Technology®)

The Sage DART features a short-range fast action for chasing wary trout in clear water, close quarters or obstacle-ridden streams. Specifically designed to cast precise loops while still providing delicate presentations and delightful feedback to the angler. The KonneticHD materials combined with performance-friendly fast action gives fishermen the ultimate competitive advantage against highly selective trout. The ultra-light 7ft 6ins models provide the backbone of this family while the shorter 6ft 6ins model provides the specialist rod for the angler looking for accuracy in extremely confined areas.

Key Features

- Vera wood insert with bronze anodised aluminium up-locking reel seat
- Super plus snub-nose, half-wells cork handle
- KonneticHD technology®
- Sapling green blank colour
- Bronze thread wraps with gold trim wraps
- Fuji ceramic stripper guides with ultra-light hard chromed snake guides and tip
- Tan rod bag with brown logo and model tag
- Portobello coloured powder coated aluminium rod tube with Sage medallion

Code 18B0008

Length	Line	Sections	Handle	Wt.(oz)	Price
7'6"	#1	3	A	1.8	£825.00
7'6"	#2	3	A	1.9	£825.00
6'6"	#3	3	A	1.7	£825.00
7'6"	#3	3	A	2.0	£825.00
7'6"	#4	3	A	2.1	£825.00

Sage FOUNDATION Fly Rods (Graphite IIIe)

The Sage FOUNDATION is a fast-action rod designed for a wide range of fishing situations. Built on a high-performance (Graphite IIIe) blank which provides excellent casting power and effortless control and accuracy. It's the very foundation of what defines a Sage rod - performance - helping to take your casting to another level.

Key Features

- Sage Graphite IIIe technology
- "Stealth black" matt blank with black wraps with silver trim
- Ceramic stripper guides and hard chrome snake guides
- Black anodised aluminium uplocking reel seat
- Snub nose cork handle with fighting butt on larger sizes
- Rugged black cordura rod tube
- Handcrafted on Bainbridge Island, USA

Code 17B0004

Length	Line	Sections	Handle	Wt.(oz)	Price
9'0"	#4	4	B	2.8	£499.00
9'0"	#5	4	B	3.0	£499.00
9'0"	#6	4	B	3.2	£499.00
9'0"	#8	4	C	3.8	£499.00
10'0"	#7	4	C	3.0	£499.00

Sage TROUT LL Fly Rods

The Sage TROUT LL is designed as a moderate action, smooth casting, deadly accurate, tippet protecting trout rod. The TROUT LL specialised lengths are perfected for short casts, small flies and light tippets. With its traditional smooth casting action this rod adds modern performance in accuracy and loop control through the backbone of its Konnetic HD blank material and will quickly become your best friend.

Key Features

- Konnetic HD Technology®
- Walnut wood insert
- Bronze thread wraps with gold trim
- Fuji® ceramic stripper guides
- Hard chrome snake guides and tip top
- Walnut wood inserts with bronze up-locking seat
- Floor grade, snub nosed, half wells cork handles
- Tan rod bag with brown logo and model tag
- Brown powder coated aluminium rod tube with Sage medallion

Code 19B0005

Length	Line	Sections	Handle	Wt.(oz)	Price
7'9"	#3	4	D	2.1	£925.00
8'6"	#4	4	D	2.2	£925.00
8'9"	#3	4	D	2.2	£925.00
8'6"	#5	4	D	2.4	£925.00
9'0"	#4	4	D	2.4	£925.00
9'0"	#5	4	D	2.5	£925.00
9'0"	#6	4	D	2.6	£925.00



“Designed specifically for European style nymphing techniques.”

Sage's Generation 5 Technology



Snub-nosed half-wells cork handle

Anodised aluminium down-locking reel seat

A



SPORTFISH RECOMMENDED RIO 2-Tone Indicator **SEE PAGE 30**



SPORTFISH RECOMMENDED RIO Euro Nymph Leader **SEE PAGE 30**



SPORTFISH RECOMMENDED Sage ESN Reels **SEE PAGE 39**



KonneticHD Technology®

Black ice blank colour with garnet thread wraps with metallic charcoal trim wraps

B



Black anodised aluminium down-locking reel seat

Sage SENSE Nymphing Fly Rods

Designed specifically for European style nymphing techniques, the Sage SENSE is built around a soft tip action for increased shock absorption when working precise nymph rigs with fine diameter tippets, preventing tip 'bounce' which can lead to broken tippet or lost fish. The soft tip moves down into a more powerful butt section to allow for controlled fish fighting and minimal recoil. Stealthy cosmetics and lightweight components complete the rod and make it the perfect tool for those looking to get the most out of their light line techniques.

Key Features

- Sage's Generation 5 Technology
- Stealth grey blank colour
- Lightweight Fuji stripper guide optimally positioned for tight line nymphing
- Hard chromed single-foot snake guides
- Snub nosed half-wells cork handle
- Anodised aluminium down-locking reel seat
- Rugged black cordura rod tube with divided liner

Code 22A0019

Length	Line	Sections	Handle	Wt.(oz)	Price
10'0"	#3	4	B	3.1	£749.00
10'0"	#4	4	B	3.2	£749.00
10'6"	#3	4	B	3.2	£749.00

Sage ESN European Style Nymphing Fly Rods

The Sage ESN rods are designed specifically for European Style Nymphing techniques developed to maximise catch rates. Built with a KonneticHD backbone, the ESN allows anglers to experience unmatched blank recovery, increased sensitivity, reduced weight-in-hand, and superior shock absorption to better hold fish. The refined medium action has been designed with a variety of long and short line techniques and situations in mind, allowing you to confidently work any stretch of river.

Key Features

- KonneticHD Technology®
- Black ice blank colour
- Garnet thread wraps with metallic charcoal trim wraps
- Fuji® ceramic stripper guides with hard chrome single foot snake guides
- Black anodised aluminium down-locking reel seat

Code 16B0006

Length	Line	Sections	Handle	Wt.(oz)	Price
10'0"	#2	4	A	2.5	£995.00
10'0"	#3	4	A	2.6	£995.00
10'0"	#4	4	A	2.6	£995.00
10'6"	#3	4	A	2.7	£995.00



MORE FIGHT, MORE TOUCH

Sage SALT R8 Fly Rods

Most salt rods are built for power and strength, often sacrificing feel and touch. When developing the ultimate saltwater rod, Sage took their new R8 graphite and added 25% more strength-per-weight without the need to add more material, fillers or reinforcement. To maintain feel for fine touch shots and precise presentations, their rod designers shaped a taper and found the right profile and fibre alignment that delivered strength, fine touch presentation, and a more intuitive sweet spot. The result is the SALT R8. Gone are the days of unwieldy and unforgiving saltwater rods.

Key Benefits

- 25% increased strength for greater pulling power and quicker fish landing
- Enhanced durability and toughness to withstand more rugged situations
- Intuitive sweet spot that prioritises touch and speed for shorter shots and on-demand casts
- Saltwater specific guide set - Fuji K-guides resist corrosion, while their angled, oversized shape prevents snags
- Heavy-duty reel seat with oversized locking rings to keep the reel tight to the rod for greater contact, rigidity and a more direct connection when fighting powerful fish

Key Features

- Sage's R8 technology
- Tempest blue blank colour
- Slate primary thread wraps with graduated white and grey trim
- Premium flor grade cork handle w/EVA butt
- Black rod bag with new cord lock for quicker, easier and cleaner storage
- Aluminium rod tube with Sage medallion

Code 23A0033

Additional sizes are available please visit www.sportfish.co.uk or call 01544 327111 for more information.



Sage ENFORCER Reels
SEE PAGE 38

Length	Line	Sections	Handle	Wt.(oz)	Price
9'0"	#7	4	A	3.8	£1099.00
9'0"	#8	4	A	4.0	£1099.00
9'0"	#9	4	A	4.1	£1099.00
9'0"	#10	4	A	4.5	£1099.00
9'0"	#11	4	A	5.0	£1099.00
9'0"	#12	4	B	5.3	£1099.00



Enhanced durability and toughness to withstand more rugged situations

25% increased strength for greater pulling power and quicker fish landing

Premium flor grade cork handle w/EVA butt

Pacific Blue colour blank



Super-grade full-wells cork handle with cork & EVA fighting butt

Aluminium reel seat with hidden hook keeper

Sage MAVERICK Fly Rods (Konnetic Technology®)

The Sage MAVERICK has been designed using Konnetic Technology®, the highest energy-transferring material that Sage has ever created, to meet the unique demands of the modern saltwater fly angler. Responding to the need to present a quick and accurate cast to a sighted fish, the MAVERICK is designed to excel in those 'quick shot' situations where the ability to react quickly can make all the difference. With a powerful tip section that drives the casting load down to its robust mid-sections, the MAVERICK is ready for any saltwater challenge that faces it.

Key Features

- Pacific blue colour blank
- Charcoal primary thread wraps with light grey trim
- Oversized Fuji ceramic stripper guides and hard chromed snake guides and tip-top
- Aluminium reel seat with hidden hook keeper
- Super-grade full-wells cork handle with cork & EVA fighting butt
- Matt black powder coated aluminium rod tube with Sage medallion and black rod bag

Code 20A0047

Length	Line	Sections	Handle	Wt.(oz)	Price
9'0"	#6*	4	C	3.8	£749.00
9'0"	#7	4	C	3.9	£749.00
9'0"	#8	4	C	4.0	£749.00
9'0"	#9	4	C	4.1	£749.00
9'0"	#10	4	C	4.7	£749.00
9'0"	#11	4	C	5.1	£749.00
9'0"	#12	4	C	5.8	£749.00
8'6"	#14*	4	C	6.6	£749.00

*9'0" #6 and 8'6" #14 are special order sizes and could take 10-14 days to deliver.

HARDY
ALNWICK | ENGLAND

HISTORY MEETS MODERN TECHNOLOGY

FROM
£719.00



Hardy Ultralite® Fly Rods

The Hardy Ultralite® range of fly rods features SINTRIX® NSX technology - an update on the legendary SINTRIX® material. The result is an even lighter and more responsive rod without compromising on strength and power. More and more anglers are now seeking greater 'feel' in their fingertips, whilst still retaining the casting properties of a fast-actioned rod - the Hardy Ultralite® range is the answer.

Key Features

- Made with SINTRIX® NSX, Hardy's highest grade SINTRIX® material
- Totally redesigned medium-fast action blank design
- Ceramic lined titanium REC recoil guides and black pearl recoil guides
- Ultralite custom laser engraved reel seat with line size
- 4-piece rods for convenient travel
- Supplied in a sectioned cloth bag and an aluminium rod tube

Code 20B0010

Additional sizes are available please visit www.sportfish.co.uk or call 01544 327111 for more information.



SPORTFISH RECOMMENDED

Hardy Ultralite (UDLA) Reels
SEE PAGE 35

UltraLite NSX
SINTRIX

Length	Line	Sections	Handle	Wt.(oz)	Price
8'0"	#4	4	A	2.5	£719.00
8'6"	#4	4	A	2.6	£719.00
8'6"	#5	4	A	2.8	£719.00
9'0"	#4	4	A	2.8	£729.00
9'0"	#5	4	A	3.0	£729.00
9'0"	#6	4	A	3.0	£729.00
9'6"	#6	4	B	3.5	£739.00
9'6"	#7	4	B	3.8	£739.00
10'0"	#5	4	A	3.5	£759.00
10'0"	#6	4	B	3.7	£759.00
10'0"	#7	4	B	3.9	£759.00
10'0"	#8	4	B	4.0	£759.00



Made with SINTRIX® NSX, Hardy's highest grade SINTRIX® material

"A lighter and more responsive rod without compromising on strength and power."



Totally redesigned medium-fast action blank design

A

B



HARDY

ALNWICK | ENGLAND

FROM
£579.00

“An addition to the award winning Hardy Ultralite rod range.”

SINTRIX® NSX construction

PSG handle

Lightweight reel seat

UltraLite NSX
SINTRIX

Hardy Ultralite® SR (Small River) Fly Rods

This addition to the award winning Hardy Ultralite rod range is aimed at anglers casting into tight spots on small streams for wily wild trout. Made with SINTRIX® NSX material for an easy loading action and accuracy at close range, combined with a forgiving feel that protects light tippets. The range also includes 6-piece travel variants for those anglers looking for the ultimate in portability.

Key Features

- SINTRIX® NSX construction
- Optimum blend of finesse and power for small stream techniques
- Ceramic lined titanium recoil guides
- Lightweight reel seat
- Supplied in a hard travel tube
- PSG (Perfection Style Grip) handles

Code 21B0026

Additional sizes are also available, please visit www.sportfish.co.uk or call 01544 327111 for more information.

Length	Line	Sections	Handle	Wt.(oz)	Price
6'6"	#4	4	A	1.4	£579.00
7'0"	#3	4	A	1.6	£579.00
7'6"	#3	4	A	1.7	£639.00
7'6"	#4	6-Travel	A	1.8	£639.00
8'0"	#3	4	A	1.7	£639.00
8'8"	#4	6-Travel	A	1.9	£639.00
9'0"	#5	6-Travel	A	2.2	£669.00

FROM
£739.00

Lightweight blank design maximises line feel and sensitivity

Hardy Ultralite® LL Fly Rods

With the recent surge in popularity of modern 'Euro nymphing' and competition style river techniques, the Ultralite® LL range has been designed and developed by some of the leading figures in modern light line river fishing. From fine dry fly work to Euro nymphing, this series truly covers every technical trout fishing scenario. Don't struggle any more with long nymphing leaders and indicators - grab yourself a Hardy Ultralite® LL and open up a whole world of possibilities.

Key Features

- Made with Hardy's unique SINTRIX® NSX combined with a greater percentage of high modulus carbon fibre
- Lightweight blank design maximises line feel and sensitivity
- Down-locking reel seats on key longer sizes for improved balance
- Ceramic lined titanium REC recoil guides and black pearl recoil guides
- Rod of choice for highly technical situations
- 4-piece rods for convenient travel
- Supplied in a sectioned cloth bag and an aluminium rod tube

Code 20B0011

Additional sizes are available please visit www.sportfish.co.uk or call 01544 327111 for more information.

UltraLite NSX
SINTRIX

Length	Line	Sections	Handle	Wt.(oz)	Price
9'2"	#3	4	B	2.8	£739.00
9'2"	#4	4	B	2.9	£739.00
9'9"	#3	4	B	3.0	£739.00
9'9"	#4	4	B	3.1	£739.00
10'2"	#2	4	C	3.2	£799.00
10'8"	#0-2	4	C	3.5	£799.00
10'8"	#3	4	C	3.5	£799.00
11'2"	#2	4	C	3.6	£799.00

Down-locking reel seats on key longer sizes for improved balance

HARDY

ALNWICK | ENGLAND

FROM
£799.00

Rod of choice for high performance extreme situations

“A powerful fly rod from Hardy designed for the most challenging of fishing conditions.”

Hardy Ultralite® X (Extreme) Fly Rods

If you're faced with extreme wind, require serious distance casts or have to throw bulky flies, this rod is made for you. The Ultralite® X rises to those challenges with a significantly faster action than Hardy's standard Ultralite® rods and a super-fast recovery rate for driving tight loops forward with precision. The rod's powerful butt section has been designed for lifting sunk lines, throwing lines with aggressive front tapers and for putting some serious pressure on hard fighting fish.

Key Features

- SINTRIX® NSX combined with a greater percentage of high modulus carbon fibre
- Rapid taper blank design maximises material performance
- Ceramic lined titanium recoil guides
- Rod of choice for high performance extreme situations
- 4-piece rods for convenient travel
- Supplied in a sectioned cloth bag and an aluminium tube

Code 21B0027

Additional sizes are also available, please visit www.sportfish.co.uk or call 01544 327111 for more information.

UltraLite NSX

SINTRIX

Length	Line	Sections	Handle	Wt.(oz)	Price
9'0"	#5	4	A	3.0	£799.00
9'0"	#6	4	A	3.0	£799.00
9'6"	#7	4	B	3.8	£899.00
10'0"	#7	4	B	3.8	£899.00



FROM
£739.00

SINTRIX® NSX combined with a high percentage of high modulus carbon fibre

“This range of switch and double-handed Ultralite® rods from Hardy brings with it increased levels of feel, in-hand balance and fish fighting power.”

Hardy Ultralite® Switch & Double-Handed Fly Rods

Each rod in the range features SINTRIX® NSX material and each has an individually customised action for the best possible performance. The range includes a switch variant, double-handed rods in the highly popular 12' 6" - 13' 6" range for medium sized salmon rivers, and 14' 6" and 15' 1" options for larger rivers and extra swing control. A selection of sizes are available in 6-pieces making them super convenient for travel.

Key Features

- SINTRIX® NSX combined with a high percentage of high modulus carbon fibre
- Application specific action design
- Ceramic lined titanium recoil guides
- 4-piece and selected 6-piece rods for convenient travel
- Supplied in a secure hard travel tube and rod bag

Code 21B0028

Additional sizes are available please visit www.sportfish.co.uk or call 01544 327111 for more information.

UltraLite NSX

SINTRIX

Length	Line	Sections	Handle	Wt.(oz)	Price
11'6"	#6/7	4	C	5.4	£739.00
12'6"	#7/8	4	C	6.1	£849.00
13'6"	#8/9	4	C	7.7	£899.00
13'6"	#8/9	6-Travel	C	7.8	£959.00
14'6"	#9/10	4	C	8.5	£959.00
14'6"	#9/10	6-Travel	C	9.1	£999.00
15'1"	#10/11	4	C	9.8	£999.00



HARDY

ALNWICK | ENGLAND



Hardy's SINTRIX multi modulus carbon fibre blank



Custom designed lightweight reel seat with a keyed reel seat slide band for ease of use

Hardy Aydon Fly Rods

A perfect blend of balance, power and recovery resulting in user-friendly casting performance and true "fishability". These lightweight rods have been designed and manufactured with Hardy's SINTRIX material and are fitted with top quality hardware and purposefully designed reel seats. Each Aydon model is perfectly tailored to meet your expectations and offers sizes to cover everything from small trout streams to larger reservoirs.

Key Features

- Hardy's SINTRIX multi modulus carbon fibre blank
- Ceramic lined stripping guides and hard chrome single foot guides
- Custom designed lightweight reel seat with a keyed reel seat slide band for ease of use
- Selected wood or aluminium spacers, depending on model
- Supplied in a quality rod bag and practical travel tube

Code 22B0014

Additional sizes are available please visit www.sportfish.co.uk or call 01544 327111 for more information.

Length	Line	Sections	Handle	Wt.(oz)	Price
7'0"	#3	4	A	2.1	£449.00
8'0"	#4	4	A	2.4	£469.00
8'6"	#5	4	A	2.8	£479.00
9'0"	#5	4	A	2.9	£509.00
9'0"	#6	4	A	3.0	£519.00
9'0"	#8	4	B	3.7	£539.00
9'6"	#6	4	B	3.7	£549.00
9'6"	#7	4	B	3.7	£559.00
10'0"	#5	4	A	3.2	£549.00
10'0"	#6	4	B	3.7	£559.00
10'0"	#7	4	B	3.8	£569.00
10'0"	#8	4	B	4.0	£579.00



"A super-convenient 6-piece configuration perfect for travel."

Hardy Aydon 6-piece Travel Fly Rods

The Aydon Travel rod series offers all the features found within the Aydon rod family but in a super-convenient 6-piece configuration perfect for travel. Offered in a wide range of sizes covering everything from small trout stream to big salmon river applications.

Key Features

- Hardy's SINTRIX multi modulus carbon fibre blank
- Ceramic lined stripping guides and hard chrome single foot guides
- Custom designed lightweight reel seat with a keyed reel seat slide band for ease of use
- Selected wood or aluminium spacers, depending on model
- Supplied in a quality rod bag and practical travel tube

Code 22B0014

Length	Line	Sections	Handle	Wt.(oz)	Price
8'0"TV	#4	6-Travel	C	2.5	£479.00
9'0"TV	#5	6-Travel	C	2.7	£529.00
9'0"TV	#6	6-Travel	C	2.9	£539.00
9'0"TV	#8	6-Travel	D	3.5	£559.00
9'6"TV	#7	6-Travel	D	3.6	£579.00
14'6"TV	#10/11	6-Travel	E	9.6	£909.00

Custom designed lightweight reel seat with a keyed reel seat slide band for ease of use



HARDY
ALNWICK | ENGLAND



Custom designed down-locking reel seats with aluminium spacers and keyed reel seat slide bands

Hardy Aydon Switch and Double Handed Fly Rods

A perfect blend of balance, power and recovery resulting in user-friendly casting performance and true "fishability". These lightweight rods have been designed and manufactured with Hardy's SINTRIX material and are fitted with top quality hardware and purpose-designed reel seats. Each Aydon model is perfectly tailored to meet your expectations and offers sizes to cover all eventualities.

Key Features

- Hardy's SINTRIX multi modulus carbon fibre blank
- Ceramic lined stripping guides and hard chrome single foot guides
- Custom designed down-locking reel seats with aluminium spacers and keyed reel seat slide bands
- Supplied in a quality rod bag and practical travel tube

Code 22B0014

Hardy Switch Rods					
Length	Line	Sections	Handle	Wt.(oz)	Price
11'0"	#5/6	4	A	4.7	£609.00
11'0"	#6/7	4	A	4.8	£629.00
11'0"	#7/8	4	A	4.9	£639.00

Hardy Double Handed Rods					
Length	Line	Sections	Handle	Wt.(oz)	Price
11'9"	#7/8	4	B	6.7	£749.00
12'9"	#8/9	4	B	7.5	£779.00
13'9"	#9/10	4	B	8.5	£839.00
14'6"TV	#10/11	6-Travel	B	9.6	£909.00
14'9"	#10/11	4	B	9.0	£879.00



Thinner, low profile, ultra-responsive blank



Made with Hardy's legendary SINTRIX® 440 for the ultimate strength to weight ratio



Hardy Zane Pro Fly Rods

If you're targeting the world's hardest-fighting game fish you need a fly rod with uncompromising performance. There's no corner-cutting with the Hardy Zane Pro - this is a serious fly rod for serious anglers and serious fish. Made from aerospace grade carbon fibre and Hardy's advanced SINTRIX® 440 material, and with ceramic-lined titanium REC recoil guides, this rod takes performance to a whole new level.

Key Features

- Made with Hardy's legendary SINTRIX® 440 for the ultimate strength to weight ratio
- Ceramic lined titanium REC recoil guides with black pearl recoil guides
- Thinner, low profile, ultra-responsive blank
- Saltwater proof, hard anodised reel seat
- Convenient 4-piece rods
- Supplied in a sectioned cloth bag and an aluminium rod tube

Code 20B0013

Additional sizes are available please visit www.sportfish.co.uk or call 01544 327111 for more information.

Length	Line	Sections	Handle	Wt.(oz)	Price
9'0"	#6	4	C	3.5	£899.00
9'0"	#7	4	C	3.7	£899.00
9'0"	#9	4	C	4.4	£959.00
9'0"	#10	4	C	4.6	£959.00
9'0"	#12	4	C	4.9	£959.00



Saltwater proof, hard anodised reel seat



“Improved actions, lower profile blank design and superb balance.”

Greys Wing Streamflex Fly Rods

Through the years the Greys Streamflex name has become synonymous with quality river fishing rods. The Greys Wing Streamflex takes that reputation to new heights offering improved actions, lower profile blank design and superb balance to help promote in-hand feel and excellent line control. The Wing Streamflex Plus with its 12" extension piece offers added versatility to create the ultimate all round light line river rod.

Key Features

- Greys Powerlux 4-piece carbon blanks
- Quality AAA grade cork handles
- Lined stripper guides and single foot snake guides
- Alloy reel seat with selected wood spacers and dual locking nuts
- Keyed & milled reel seat slide band
- Rod section model ID & alignment dots
- Supplied in a rod bag and hard tube

Code 22B0015

Additional sizes are available please visit www.sportfish.co.uk or call 01544 327111 for more information.

Greys Wing Streamflex Rods					
Length	Line	Sections	Handle	Wt.(oz)	Price
6'6"	#3	4	A	2.1	£309.00
7'0"	#3	4	A	2.2	£319.00
7'6"	#4	4	A	2.4	£329.00
8'0"	#4	4	A	2.4	£339.00
8'6"	#5	4	A	2.6	£339.00
9'0"	#3	4	A	2.6	£349.00
9'0"	#4	4	A	2.8	£359.00
9'0"	#5	4	A	3.0	£369.00
9'0"	#6	4	A	3.1	£369.00
10'0"	#3	4	B	3.0	£399.00
10'0"	#4	4	B	3.1	£409.00
10'0"	#5	4	B	3.2	£419.00
10'6"	#3	4	B	3.2	£429.00
9'8"/10'8"	#2/3	4/5	A	3.2	£449.00

FROM £309.00

Greys Powerlux 4-piece carbon blanks



Greys Wing Stillwater and Saltwater Fly Rods

The Greys Wing Stillwater rods are designed specifically for those anglers targeting lakes and reservoirs or situations generally requiring more power and distance. Utilising Greys' Powerlux carbon blanks, the Stillwater range features longer rods with actions specifically designed to handle a wide range of line densities from floating to fast sinking. Saltwater version also available with saltwater specific design and action.

Code 22B0015

Greys Wing Travel Fly Rods					
Length	Line	Sections	Handle	Wt.(oz)	Price
9'0" Travel	#5	6-TR	A	3.1	£429.00
9'0" Travel	#8	6-TR	C	4.0	£449.00
14'0" Travel	#8/9	6-TR	E	8.8	£599.00

Greys Wing Stillwater Fly Rods					
Length	Line	Sections	Handle	Wt.(oz)	Price
9'6"	#6	4	C	3.5	£389.00
9'6"	#7	4	C	3.6	£399.00
10'0"	#7	4	C	3.9	£409.00
10'0"	#8	4	C	4.1	£409.00

Greys Wing Saltwater Fly Rods					
Length	Line	Sections	Handle	Wt.(oz)	Price
9'0"	#8	4	D	3.8	£399.00
9'0"	#9	4	D	4.1	£409.00
9'0"	#10	4	D	4.7	£419.00

NEW

Greys Wing Double Handed Fly Rods

The Greys Wing Double Handed rods are specifically designed for swinging flies on big rivers for salmon and sea trout, covering distant lies with accuracy and control and battling powerful fish. These rods feature Greys' Powerlux carbon blanks with a lower profile to create superb balance and help promote in-hand feel and excellent line control.

Code 22B0015

Greys Wing Double Handed Fly Rods					
Length	Line	Sections	Handle	Wt.(oz)	Price
12'6"	#7/8	4	E	7.0	£529.00
13'6"	#8/9	4	E	8.0	£569.00
14'0" Travel	#8/9	6-TR	E	8.8	£599.00
14'6"	#9/10	4	E	8.6	£599.00

Quality AAA grade cork handles

A

B

C

D

E



“High-performance action with fast recovery.”

FROM £199.00

NEW

Greys Kite Fly Rods

Greys Kite rods are built on high intermediate modulus Greys Toreon® blanks offering several performance and convenience upgrades. The Kite series also includes section alignment dots, model ID, captive slide band alloy reel seats, and AAA grade cork handles. The expanded Kite range includes single handed, switch and double handed models perfectly suited to cover all eventualities.

Key Features

- Convenient 4-piece Toreon® carbon blanks
- High-performance action with fast recovery
- Quality AAA grade cork handles
- Lined stripper guides with single foot snake guides
- Alloy reel seat with selected wood or alloy spacers dependant on model with dual locking nuts and a keyed reel seat slide band
- Rod section model ID & alignment dots
- Supplied in a rod bag and hard tube

Code 22B0012

Additional sizes are available please visit www.sportfish.co.uk or call 01544 327111 for more information.



SPORTFISH RECOMMENDED
RIO Mainstream Trout Fly Line
SEE PAGE 57

Greys Kite Single Handed Rods

Length	Line	Sections	Handle	Wt.(oz)	Price
6'0"	#3	4	A	2.2	£199.00
6'6"	#4	4	A	2.3	£199.00
7'0"	#3	4	A	2.3	£229.00
8'0"	#4	4	A	2.5	£249.00
8'6"	#5	4	A	2.9	£249.00
9'0"	#5	4	A	3.0	£269.00
9'0"	#6	4	A	3.1	£279.00
9'0"	#8	4	B	3.9	£279.00
9'6"	#6	4	B	3.7	£289.00
9'6"	#7	4	B	3.8	£289.00
9'6"	#8	4	B	4.0	£289.00
10'0"	#6	4	B	3.9	£299.00
10'0"	#7	4	B	3.9	£299.00
10'0"	#8	4	B	4.1	£299.00

Greys Kite Switch Rods

Length	Line	Sections	Handle	Wt.(oz)	Price
11'1"	#6/7	4	C	5.5	£369.00
11'1"	#7/8	4	C	5.6	£369.00
11'1"	#8/9	4	C	5.7	£369.00

Greys Kite Double Handed Rods

Length	Line	Sections	Handle	Wt.(oz)	Price
13'0"	#8/9	4	D	10.9	£389.00
14'0"	#9/10	4	D	10.9	£399.00
15'0"	#10/11	4	D	11.1	£399.00



FLY RODS GREYS



4-piece intermediate modulus carbon blank



“The Lance delivers performance well above its price.”

Quality AAA cork handle

Greys Lance Fly Rods

Built on an intermediate modulus carbon fibre blank the Lance delivers performance well above its price. This family of performance fly rods offers both novice and experienced anglers alike quality features including high quality all-alloy reel seats, quality cork grips and alignment dots.

Key Features

- 4-piece intermediate modulus carbon blank
- High-performance user-friendly casting action
- Quality AAA cork handle
- Lined stripper guides with single foot snake guides
- Anodised alloy reel seat with dual locking nuts and a reel seat slide band with alignment mark
- Alignment dots on each section
- Secure sectioned rod tube

Code 22B0013



SPORTFISH RECOMMENDED Greys FIN Fly Reels
SEE PAGE 44

Length	Line	Sections	Handle	Wt.(oz)	Price
7'6"	#3	4	A	2.5	£139.99
8'0"	#4	4	A	2.7	£149.99
8'6"	#5	4	A	3.1	£149.99
9'0"	#5	4	A	3.2	£159.99
9'0"	#6	4	A	3.4	£159.99
9'0"	#8	4	B	3.7	£179.99
9'6"	#6	4	B	3.7	£169.99
9'6"	#7	4	B	3.8	£169.99
9'6"	#8	4	B	4.0	£169.99
10'0"	#7	4	B	4.1	£179.99
10'0"	#8	4	B	4.1	£179.99

Good quality set up.
Does the job!
Took this out for the first time a couple of weeks ago and landed 8 rainbows.

CUSTOMER REVIEWS

CRAIG
July 2020

Hook keeper ring on all models

'AAA' grade natural cork handle

Greys GR20 Fly Rods

The Greys GR20 rods are the perfect stepping stone into the Greys rod range at an affordable price without any sacrifices. They are ideal as a first fly rod or as a spare rod. Easy casting, tough and offering many features normally found in rods costing much more.

Key Features

- Intermediate modulus blank
- Smooth yet powerful medium action
- Hard lined butt guides and chrome snake intermediates
- Anodised aluminium saltwater safe reel seat
- Section line-up marks
- Hook keeper ring on all models
- 'AAA' grade natural cork handle
- Supplied with a tough cordura rod tube

Code 17B0021



SPORTFISH RECOMMENDED Wychwood Feather Floater Fly Line
SEE PAGE 58

Length	Line	Sections	Handle	Wt.(oz)	Price
8'0"	#4	4	C	2.9	£84.99
8'6"	#5	4	C	3.2	£89.99
9'0"	#5	4	C	3.4	£94.99
9'0"	#6	4	C	3.5	£99.99
9'6"	#7	4	D	4.1	£109.99
10'0"	#7	4	D	4.2	£119.99

Anodised aluminium saltwater safe reel seat

Shakespeare®

SINCE 1897

FROM
£79.99

Full Wells with Extension (FW + EX) handle

Aluminium reel seat



Shakespeare Oracle 2 Stillwater Fly Rods

The legendary Oracle series is back! This offering from Shakespeare provides high-performance, fast-action rod characteristics at an amazing price point. With smart cosmetics and a practical rod tube, this is a great piece of kit for stillwater and reservoir anglers which doesn't break the bank.

Key Features

- Convenient 4-piece design
- Light fast action blank
- Gunmetal coloured blank
- Lined stripper guides
- Aluminium reel seat
- Reverse Half Wells (RHW) or Full Wells with extension (FW+EX) handles
- Rods of 9ft 6ins and above supplied with both 3cm and 10cm extensions
- Hard partitioned rod tube

Code 21B0021

Length	Line	Sections	Handle	Wt.(oz)	Price
9'0"	#5	4	RHW	4.2	£79.99
9'0"	#6	4	RHW	4.2	£79.99
9'6"	#6	4	FW+EX	5.3	£89.99
9'6"	#7	4	FW+EX	5.3	£89.99
10'0"	#6	4	FW+EX	5.6	£109.99
10'0"	#7	4	FW+EX	5.6	£109.99
10'0"	#8	4	FW+EX	5.7	£109.99

FROM
£84.99

Dark green coloured blank

Reverse Half Wells (RHW) handle with a wood spacer reel seat



Shakespeare Oracle 2 River Fly Rods

This range of medium-fast actioned rods is aimed at river anglers looking for high performance at a great price. Designed with the same smart cosmetics and sturdy rod tube as other Oracle 2 variants, these rods will suit a whole host of river fishing applications, from small stream fishing to dry fly fishing, streamer fishing and Euro-nymphing.

Key Features

- Convenient 4-piece design
- Light medium-fast action blank
- Dark green coloured blank
- Lined stripper guides
- Reverse Half Wells (RHW) handle with a wood spacer reel seat
- Hard partitioned rod tube

Code 21B0021

Length	Line	Sections	Handle	Wt.(oz)	Price
6'0"	#3	4	RHW	2.6	£84.99
7'0"	#4	4	RHW	2.8	£84.99
7'6"	#4	4	RHW	2.8	£89.99
8'0"	#4	4	RHW	2.9	£89.99
8'6"	#4	4	RHW	3.2	£89.99
8'6"	#5	4	RHW	3.4	£89.99
9'0"	#4	4	RHW	3.5	£89.99
9'0"	#5	4	RHW	3.6	£89.99
10'0"	#3	4	RHW	3.8	£89.99
10'0"	#4	4	RHW	3.9	£89.99
10'0"	#5	4	RHW	3.9	£94.99

FROM
£119.99

Two Part Shaped Fly (TPSF) handles



Shakespeare Oracle 2 Switch & Double-Handed Fly Rods

An excellent range of great value fly rods for use with both long-bellied Spey style lines as well as Scandi and Skagit shooting heads. Selected sizes in the range are available in 6-piece versions to provide convenience for the travelling salmon, sea trout and steelhead fisher.

Key Features

- 4pce and 6pce designs for convenience & performance
- Spey style blank design perfect for various line styles
- Spey and switch have gunmetal coloured blanks
- 6-piece travel rods have dark blue blanks
- Lined stripper guides
- Aluminium reel seat
- Two Part Shaped Fly (TPSF) handles
- Supplied in a hard sectioned tube

Code 21B0022

Length	Line	Sections	Handle	Wt.(oz)	Price
11'0" Switch	#6/7	4	TPSF	6.0	£119.99
11'0" Switch	#7/8	4	TPSF	6.3	£119.99
11'0" Switch	#8/9	4	TPSF	6.5	£119.99
12'0" Spey	#8	4	TPSF	8.8	£119.99
12'9" Spey	#8	6-Travel	TPSF	9.0	£169.99
13'0" Spey	#8	4	TPSF	9.5	£129.99
13'9" Spey	#9	6-Travel	TPSF	9.7	£179.99
14'0" Spey	#9	4	TPSF	10.2	£139.99
15'0" Spey	#10	4	TPSF	10.9	£139.99

HANDCRAFTED FROM START TO FINISH



FROM
£999.00

ROD TECHNOLOGY



Carbon Web

Scott's all new Carbon Web technology makes the rod lighter and more accurate.



CeRecoil

CeRecoil stripping guides combine nickel titanium frames that will return to their original shape if bent with super slick, Zirconia inserts. CeRecoil guides will never corrode.



ReAct

ReAct technology significantly increases the recovery speed and minimises vibrations of the blank maximising the feel and efficiency of the cast.



If you're after one rod for your UK bass fishing then this is it. Easily casts large bass flies.

CUSTOMER REVIEWS

Great in windy conditions, I use a SA MPX fly line and RIO intermediate line. This is now my go to saltwater fly rod.

SHIBBS

August 2021



Carbon Web technology

“Designed to cast tight, high line-speed loops effortlessly and turn over your leader straight into the wind”

Scott Sector Fly Rods

The Scott Sector is designed to cast tight, high line-speed loops effortlessly and turn over your leader straight into the wind. Scott's Carbon Web technology improves the Sector's torsional stability and durability making the rod lighter and more accurate. The Sector features game changing, flexible CeRecoil stripping guides with nickel titanium frames and super slick Zirconia inserts, along with Recoil nickel titanium snake guides. These guides are then PVD coated in a low reflective coating for even greater durability and stealth. Even the aluminium reel seats are special with self-indexing slide hoods and line weight engravings.

Key Features

- Carbon Web technology
- Flexible CeRecoil stripping guides with nickel titanium frames and super slick Zirconia inserts
- Recoil nickel titanium snake guides
- Customised aluminium reel seats
- Modified wells for grade cork handles

Code 20A0016

Length	Line	Sections	Handle	Price
9'0"	#6*	4	A	£999.00
9'0"	#7*	4	A	£999.00
9'0"	#8	4	A	£999.00
9'0"	#9	4	A	£999.00
9'0"	#10	4	A	£999.00
9'0"	#11	4	A	£999.00
9'0"	#12	4	A	£999.00

*9'0" #6 and *9'0" #7 are special order sizes and could take 10-14 days to deliver.



Modified wells for grade cork handles

A

Customised aluminium reel seats

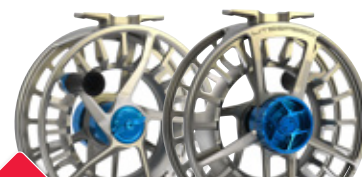

SPORTFISH RECOMMENDED

Lamson Litespeed LSM 'Marine' Reels
SEE PAGE 41



SPORTFISH RECOMMENDED

SA Amplitude MPX Fly Line
SEE PAGE 56

FRESH, FAST, AND UNFILTERED



Scott Centric Fly Rods







Scott's Centric fly rods are designed to combine feel with fast action performance. Delivering new levels of stability, recovery speed and casting range, they provide anglers with plenty of feedback through easy flexing tip sections and highly transmissive blanks.

The result is a rod that enables high line speed, flat, stable loops and superior distance and accuracy with minimal effort from the caster. The Scott Centric series is a great choice for anglers of all skill levels and they are a joy to fish at both short and long range. The ability to control loop shape and line speed at any distance makes them a highly versatile family of rods.

Centric rods combine new tapers and a new resin system to increase fibre density and reduce weight, providing high level ARC reinforcement for greater strength along multiple axes.

Scott Centric rods are completed with Flor grade cork, titanium stripping guides with super slick zirconia inserts, low glare Snakebrand Universal snake guides and a fully milled reel seat, all handcrafted in the USA from the finest materials.

Key Features

-  **ReAct**
ReAct technology increases the recovery speed and minimises vibrations which maximise the feel and efficiency of the cast
-  **Carbon Link**
Carbon Link construction technology makes a lighter more efficient rod
-  **Arc 2**
Advanced Reinforced Carbon2 improves strength, accuracy, and line control
-  **X-Core**
Expanded Core technology delivers enhanced feel, incredible stability and unequalled performance
-  **Multi Modulus**
Multi Modulus fibre technology results in a rod that loads and unloads more smoothly.
-  **Natural Finish**
Scott's Natural Finish makes the rod lighter, more durable and better performing.
-  **MIL-SPEC III**
MIL-SPEC III anodising creates the hardest, most durable and most corrosion resistant aluminium reel seats.

Code 21A0047

Length	Line	Sections	Handle	Price
8'6"	4	4	B	£949.00
9'0"	4	4	B	£949.00
9'0"	5	4	B	£949.00
9'0"	6	4	B	£949.00
9'6"	6	4	C	£949.00
10'0"	6	4	C	£949.00

Additional sizes are available please visit www.sportfish.co.uk or call 01544 327111 for more information.



Advanced Reinforced Carbon2 improves strength, accuracy, and line control



ReAct technology increases the recovery speed

Carbon Link construction technology makes a lighter more efficient rod

Scott's Natural Finish makes the rod lighter, more durable and better performing



SPORTFISH RECOMMENDED Larson Litespeed LSF Reel **SEE PAGE 41**



SPORTFISH RECOMMENDED SA Mastery MPX Fly Line **SEE PAGE 56**

I own two of these rods. The 10ft 4wt is my main hill loch rod for wild browns. It's incredible. I also have the 9ft 6wt which is on a whole other level and has become my go to multi-use fly rod. Nothing is too much for the 9ft 6wt; D17 with a booby, no bother. Size 16 dry fly on a 15ft leader, easy. If you have the means buy these rods. They are expensive but honestly worth every penny.

CUSTOMER REVIEWS

YVES

October 2022

mackenziedtx
DESIGNED THROUGH EXPERIENCE

The Mackenzie DTX (Designed Through Experience) is a brand of the highest quality products established in Scotland in 2007 by Scott Mackenzie, 3 times world Spey casting champion. Using his vast knowledge and experience collected throughout the 22 years as a full time ghillie, Scott created some of the best quality, award winning fly rods and lines available today.

ROD TECHNOLOGY

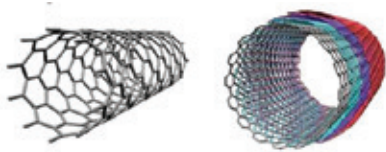

Single and multi-walled graphene nano tube

Uses graphene, a Nobel Prize winning material



SPORTFISH RECOMMENDED

Mackenzie NX Spey Line
SEE PAGE 67

A

B

C

D

Mackenzie FX2 Graphene Single Handed Rods

NEW

The Mackenzie FX2 Graphene single handed rods are 2nd generation rods made with Nobel Prize winning Graphene (the lightest, strongest material known to man) and built using Mackenzie's brand-new aerospace carbon technology. The result is the lightest, strongest range of rods on the market today. They are powerful with faster tip recovery yet retaining a fairly deep progressive action and great sensitivity.

Key Features

- Uses Graphene, a Nobel Prize winning material
- Constructed with FX2 technology
- Custom made aluminium reel seat
- Titanium snake eyes & stripper guides
- High quality flor grade Portuguese cork handle.
- Aluminium rod tube and cloth bag

Code 23A0050

Length	Line	Sections	Handle	Wt.(oz)	Price
9'0"	#5	4	A	2.9	£749.00
9'0"	#6	4	A	3.1	£749.00
9'6"	#6	4	B	3.7	£769.00
10'0"	#6	4	B	4.0	£799.00
10'0"	#7	4	B	4.1	£799.00

Mackenzie FX2 Graphene Double Handed / Switch Rods

NEW

Mackenzie FX2 Graphene double handed and switch rods are 2nd generation rods made with Nobel Prize winning Graphene (the lightest, strongest material known to man) and built using Mackenzie's brand-new aerospace carbon technology. The result is the lightest, strongest range of rods on the market today. They are powerful with faster tip recovery yet retaining a fairly deep progressive action and great sensitivity.

Key Features

- Uses Graphene, a Nobel Prize winning material
- Constructed with FX2 technology
- Custom made aluminium reel seat
- Titanium snake eyes & stripper guides
- High quality flor grade Portuguese cork handle.
- Beautiful aluminium rod tube and cloth bag

Code 23A0050

Length	Line	Sections	Handle	Wt.(oz)	Price
11'2" Switch	#7/8	4	C	5.9	£849.00
13'0" Double	#8	4	D	8.2	£1039.00
14'0" Double	#9	4	D	10.3	£1059.00

Mackenzie FX2 Graphene 6-PIECE Atlas Travel Rods

NEW

These 6-piece travel rods are 2nd generation rods made from Nobel Prize winning Graphene (the lightest, strongest material known to man), and built using Mackenzie's brand-new aerospace carbon technology. The result is the lightest, strongest range of rods on the market today. They are powerful with faster tip recovery yet retaining a fairly deep progressive action and great sensitivity. These convenient 6-piece travel rods fit into your suitcase making this the go-to rod for salmon and sea trout fishing around the world.

Key Features

- Convenient 6-piece travel rod
- Uses Graphene, a Nobel Prize winning material
- Constructed with FX2 technology
- Custom made Alps aluminium reel seat
- Titanium snake eyes & stripper guides
- High quality flor grade Portuguese cork handle
- Aluminium rod tube and cloth bag

Code 23A0050

Length	Line	Sections	Handle	Wt.(oz)	Price
12'7" Atlas	#8	6-TRV	D	8.1	£1039.00
13'7" Atlas	#9	6-TRV	D	9.2	£1059.00
14'9" Atlas	#10	6-TRV	D	10.6	£1099.00

mackenzie dtx
DESIGNED THROUGH EXPERIENCE



FROM
£719.00

High quality aluminium down-locking double-nut reel seat



Mackenzie DTX NX1 Atlas Travel Double Hand Fly Rods

The Mackenzie DTX NX1 Atlas travel rods are perfect for easy travel and storage. Moving on from their award-winning designs the team at Mackenzie is very excited about this range of nano tube technology rods. The NX1 Atlas rods load slightly further down the blank than the other NX1 models but they still retain a fast recovery giving you the perfect action for casting both traditional Spey lines and the full assortment of modern-day shooting head fly lines.

Key Features

- Ultra-lightweight, satin green blanks
- Reinforced composite cork on each handle end
- Fuji stripper guides and quality snake rings
- Alignment dots on each section
- Quality down-locking reel seat
- 6-piece for easy transportation
- Protective triangular rod tube

Code 19A0050

Length	Line	Sections	Handle	Wt.(oz)	Price
11'4"	#8	6	G	5.2	£589.00
12'7"	#8	6	G	8.1	£699.00
13'7"	#9	6	G	9.2	£719.00
14'9"	#10	6	G	10.6	£739.00



Mackenzie NX Integra Shooting Head line
SEE PAGE 67

Mackenzie DTX NX1 Double Hand Fly Rods

The Mackenzie NX1 double-handed rods incorporate the latest 21st century reinforced nanotube technology which reduces weight and increases overall strength, resulting in improved feel and energy throughout the rod. These rods have been designed to handle all Spey lines, modern-day shooting heads and Skagit systems. Their medium action together with a faster than normal recovery rate creates more line speed and makes casting effortless.

Key Features

- Ultra-lightweight satin green blanks
- Quality Portuguese cork handles with composite cork at each end
- Quality stripper guides and snake eyes
- Alignment dots on each section
- High quality aluminium down-locking double-nut reel seat
- Unique triangular-section rod tube for easy transportation

Code 19A0050

Length	Line	Sections	Handle	Wt.(oz)	Price
13'0"	#8/9	4	H	8.4	£719.00
14'0"	#9/10	4	H	8.8	£739.00
15'0"	#10/11	4	H	9.2	£799.00



Mackenzie NX Spey Line
SEE PAGE 67

Mackenzie DTX NX1 Fly Rods

The range of Mackenzie NX1 single-handed rods also features reinforced nanotube technology resulting in improved strength and lightness. Designed for modern anglers they are capable of handling all modern fly lines for achieving optimum performance whether you're targeting trout on small, intimate streams or loch style fishing.

Two distinct families are available:

R=River or S=Stillwater.

Key Features

- Ultra-lightweight satin green blanks
- Quality Portuguese cork handles
- Quality stripper guides and snake eyes
- Alignment dots on each section
- High quality aluminium reel seats
- Keeper ring attached
- Unique triangular-section rod tube for easy transportation

Code 19A0050

Length	Line	Sections	Handle	Wt.(oz)	Price
R 8'6"	#3	4	I	2.4	£399.00
R 8'6"	#4	4	I	2.4	£399.00
R 8'6"	#5	4	I	2.4	£399.00
R 9'0"	#4	4	I	2.6	£429.00
R 9'0"	#5	4	I	2.6	£429.00
S 9'0"	#6	4	J	3.3	£429.00
S 9'6"	#6	4	J	3.4	£459.00
R 10'0"	#3	4	I	2.8	£479.00
R 10'0"	#4	4	I	2.8	£479.00
R 10'0"	#5	4	I	2.8	£479.00
S 10'0"	#6	4	J	3.5	£479.00
S 10'0"	#7	4	J	3.5	£479.00



Extremely light and sensitive

Four-piece, specialist Euro nymph action

11'0" #2 & #3 models have a down-locking reel seat and small green EVA fighting butt

Vision Nymphmaniac Fly Rods

Vision Nymphmaniac rods, designed by some of the best European competition anglers, offer exceptional performance at a reasonable price. Built to be super lightweight for long days on the river, and with a blank that dampens immediately after your cast – crucial for sustaining contact and feel with your nymphs. The Nymphmaniac has enough power in the tip so hooking a fish is effortless but at the same time they bend enough when fighting a fish using the powerful butt section of the rod.

Key Features

- Four-piece, specialist Euro nymph action
- Sanded unpainted blanks with green markings
- Extremely light and sensitive
- Small and light single leg guides
- Last guide before tip is a small snake guide to prevent line tangling around the guide
- Length measurements on the rod at 20, 30, 40 and 50cm
- 11'0" #2 & #3 models have a down-locking reel seat and small green EVA fighting butt
- Grey round sectioned cordura tube

Code 21A0008

Length	Line	Sections	Handle	Wt.(oz)	Price
9'6"	#3	4	A	2.4	£399.00
10'0"	#3	4	A	2.5	£399.00
10'0"	#4	4	A	2.6	£399.00
10'0"	#5	4	A	2.7	£399.00
10'6"	#3	4	A	2.7	£399.00
11'0"	#2	4	B	2.5	£429.00
11'0"	#3	4	B	2.5	£429.00



Slate blue blanks with orange markings

Extremely powerful yet lightweight

Novel reel seat design with a full wells handle and an orange EVA fighting butt

Vision Stillmaniac Fly Rods

The Vision Stillmaniac is a small family of fast action fly rods designed by competition anglers especially for stillwater fishing, helping you achieve maximum distance and power no matter how challenging the conditions are.

- The 10'0" #7 is a fast and powerful rod and was made with long casts and deeper sinking lines in mind. A superb all-round boat rod
- The 9'9" #7 is also a fast rod and is ideally suited for distance casting from the bank or boat with a range of lines
- The 9'9" #6 is a fast rod but a touch more sensitive than its bigger 10'0" brother. This version was made for fishing closer to the surface with floating, midge tip and intermediate lines

Key Features

- Four-piece, fast action
- Slate blue blanks with orange markings
- Extremely powerful yet lightweight
- Light single leg guides
- Length measurements on the rod at 40, 50, 60 and 70cm
- Novel reel seat design with a full wells handle and an orange EVA fighting butt
- Blue round sectioned cordura tube

Code 21A0009

Length	Line	Sections	Handle	Wt.(oz)	Price
9'9"	#6	4	C	3.8	£429.00
9'9"	#7	4	C	3.9	£429.00
10'0"	#7	4	C	4.0	£429.00
10'0"	#8	4	C	4.0	£429.00



36 ton Carbon blanks with black markings

Four-piece, medium-fast action

Light and sensitive

Vision Hero Fly Rods

Vision Hero fly rods offer classic medium-fast action performance and feel at a great price. An excellent choice for beginners as well as more experienced anglers looking for a supplementary setup. With a range of models tailored to different fishing styles, including for rivers, stillwaters and coastal saltwater.

Key Features

- Four-piece, medium-fast action
- 36 ton carbon blanks with black markings
- Light and sensitive
- Light single leg guides
- High-modulus low resin graphite blanks
- Brown round sectioned cordura tube

Code 21A0010

Length	Line	Sections	Handle	Wt.(oz)	Price
7'0" Little Hero	#3	4	D	2.2	£229.00
8'0" Dry Hero	#4	4	D	2.6	£229.00
9'0" Hero	#5	4	D	2.8	£229.00
9'0" Hero	#6	4	D	2.8	£229.00
9'0" Coast Hero	#7	4	E	3.7	£249.00
9'6" Long Hero	#7	4	E	3.9	£249.00
9'9" Still Hero	#6	4	E	4.2	£249.00
10" Nymph Hero	#3	4	E	2.8	£249.00
10" Nymph Hero	#4	4	E	2.9	£249.00
10" Still Hero	#7	4	E	4.4	£249.00



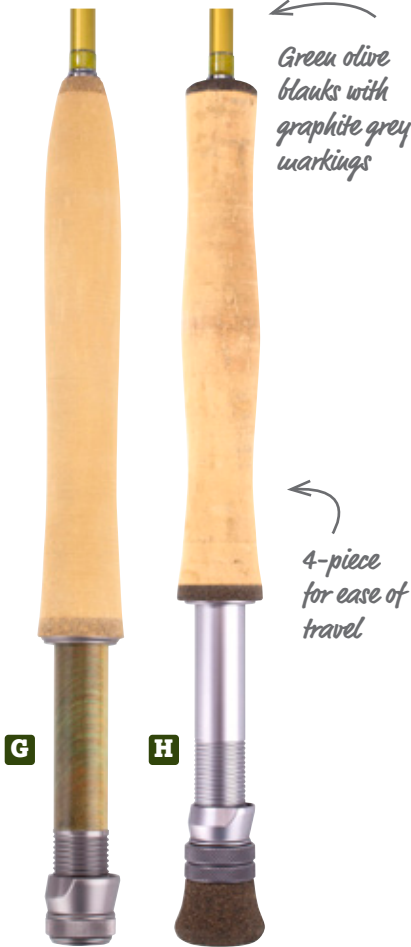

Green olive blanks with graphite grey markings

4-piece for ease of travel



Vision Onki Fly Rods

The Vision Onki rod range comprises medium-fast rods in a range of sizes to cover all possible freshwater situations that the angler could face from small streams to large windswept lakes. The Onki's high modulus blanks are very light and sensitive and are of a quality usually found in more expensive rods.

Key Features

- Medium-fast action
- Light, sensitive and easy casting
- 4-piece for ease of travel
- High-modulus (40TN) graphite blanks
- Green olive blanks with graphite grey markings
- Supplied in a tough partitioned cordura tube

Code 17B0022



Length	Line	Sections	Handle	Wt.(oz)	Price
7'6"	#3	4	G	2.3	£299.00
8'0"	#4	4	G	2.5	£299.00
9'0"	#5	4	G	2.7	£299.00
9'0"	#6	4	H	2.8	£299.00
9'6"	#6	4	H	3.6	£329.00
9'6"	#7	4	H	3.9	£329.00
10'0"	#3	4	G	2.7	£329.00
10'0"	#4	4	G	3.0	£329.00
10'0"	#6	4	H	4.3	£329.00
10'0"	#7	4	H	4.4	£329.00

Orvis Clearwater® Travel Fly Rods

Orvis Clearwater® Travel Rods are a convenient 6-piece travel version of the best-selling Clearwater® Rod Series. It is one of the best value-for-money fly rods you can buy but with a significant upgrade in performance and looks.

Key Features

- Convenient 6-piece travel version
- Black chrome blanks are with white accents
- Chrome snake & stripping guides
- Black-nickel, aluminium reel seats
- Rods with fighting butts have durable composite tips
- 25-Year Guarantee

Code 19A0035

Length	Line	Sections	Handle	Wt.(oz)	Price
8'6"	#5	6	A	3.4	£269.00
9'0"	#5	6	A	3.5	£269.00
9'0"	#6	6	A	3.6	£269.00
9'0"	#8	6	B	4.4	£269.00

Orvis Clearwater® Fly Rods

The Orvis Clearwater® is one of the best value-for-money fly rods you can buy but with a significant upgrade in performance and looks. Each rod is designed with a purpose-built profile and action to handle the kind of fishing the rod size would traditionally be used for from a medium action, small-stream rod to medium-fast freshwater rod.

Key Features

- Black chrome blanks with white accents
- Chrome snake & stripping guides
- Black-nickel, aluminium reel seats
- Rods with fighting butts have durable composite tips
- 25-Year Guarantee

Code 19A0035

Length	Line	Sections	Handle	Wt.(oz)	Price
7'6"	#4	4	C	2.7	£259.00
9'0"	#5	4	D	3.5	£259.00
9'0"	#6	4	D	3.7	£259.00
9'6"	#6	4	F	4.5	£259.00
10'0"	#3	4	E	3.7	£259.00
10'0"	#5	4	D	4.0	£259.00
10'0"	#7	4	F	4.8	£259.00
10'0"	#8	4	F	4.8	£259.00

CUSTOMER REVIEWS

The 10ft Oins #5 is a star performer. Perfect for river trout, wet or dry - put a 6wt up and it's a superb stillwater nymph/buzzer rod - also spot on for night fishing for sea trout with a 6wt floater. I've owned over 30 trout rods in my career - this one takes the biscuit. Well done Orvis!

PHIL
December 2019

SPORTFISH RECOMMENDED

Orvis Hydros Reels
SEE PAGE 43

GUIDELINE®



Guideline Elevation Fly Rods

Guideline Elevation Rods utilise the very latest in fly rod material and pattern technology, as well as making strides by using several more environmentally friendly components. These rods have a sensitive and responsive tip section combined with a smooth, progressive curve further down the blank, before meeting a powerful butt section. Easy to cast, forgiving and capable of producing accurate casts at high line speed, they are a great choice for anglers of all abilities and for a wide range of fishing scenarios. To minimise its environmental footprint the range uses low-toxic bio-based epoxy resins, does away with lead-containing chrome plating and utilises recycled REPVEVE™ polyester for the rod bag and tube cover.

Key Features

- Dark graphite grey matt blanks with no added colouration
- Medium-fast action rods
- Sustainable production and eco-friendly components
- 3-A cork handles
- KW style stripper and light wire single leg guides
- The rod tubes are made of recyclable polypropylene

Code 21A0015

Length	Line	Sections	Handle	Wt.(oz)	Price
9'0"	#5	4	A	2.5	£279.00
9'0"	#6	4	A	2.6	£279.00
9'9"	#6	4	B	3.2	£299.00
9'9"	#7	4	B	3.2	£299.00
10'0"	#6	4	B	3.3	£299.00
10'0"	#7	4	B	3.4	£299.00
10'6" Nymph Travel	#3	6	C	3.1	£335.00
11'3" Switch Travel	#7/8	6	D	5.6	£479.00
13'0" DH Travel	#8/9	6	D	6.5	£539.00
14'0" DH Travel	#9/10	6	D	7.6	£569.00
15'0" DH Travel	#10/11	6	D	9.1	£599.00

Grips are fitted with super grade cork

Custom-designed lightweight locking nuts



Guideline LPX Fly Rods

An epic range of rods from Guideline featuring C.A.P M4.0 advanced blank construction technology, with models designed for light line nymphing and river trout, right through to salmon and sea trout fishing.

The **LPX Nymph** rods are packed with lightweight components for fantastic balance and low swing weight, ideal for modern Euro nymphing. The **LPX Tactical** features a distinct action which feels both fast and deep, gradually unleashing when you load the rod, perfect for presenting dry flies and streamers with precision. Then there is the **LPX Chrome** and **LPX Chrome T** range, designed and built with a deep-loading rod action for power that kicks in earlier in the cast without sacrificing speed. These rods have a lightness, stability and responsiveness that makes them perfect tools for hunting sea trout & salmon.

Key Features

- Grips are fitted with super grade cork
- Custom-designed lightweight locking nuts
- Titanium stripper guides with zirconia inserts
- Comes with rod sock and tube made with recycled fabric
- Low toxic resins

Code 22A0020

Length	Line	Sections	Handle	Wt.(oz)	Price
10'2" Nymph	#3	4	E	2.6	£389.00
10'2" Nymph	#4	4	E	2.7	£389.00
10'8" Nymph	#3	4	E	2.8	£389.00
9'0" Tactical	#5	4	F	2.5	£429.00
9'0" Tactical	#6	4	F	2.6	£439.00
9'9" Tactical	#5	4	F	2.7	£439.00
11'7" Chrome	#7/8	4	G	5.7	£549.00
12'9" Chrome	#8/9	4	G	6.9	£699.00
13'9" Chrome	#9/10	4	G	7.4	£719.00
14'9" Chrome	#10/11	4	G	8.8	£749.00
12'6" Chrome T	#7/8	6	G	6.6	£739.00
12'9" Chrome T	#8/9	6	G	6.9	£759.00
13'9" Chrome T	#9/10	6	G	7.5	£779.00
14'9" Chrome T	#10/11	6	G	8.9	£799.00



Guideline NT11 Fly Rods

Performance, durability and reliability.

Featuring C.A.P T1 100 technology and the very latest and most sophisticated state of the art graphite materials used in the aerospace industry today and in multiple advanced construction techniques, these rods offer extreme durability and strength, low weight and remarkable recovery speed. Easy to operate with their full flex medium/fast action and tips that are rigid but still sensitive enough to make them lively and fun to cast.

Key Features

- Matt satin finish blanks with a carbon grey coating
- 6-pieces to fit in luggage when travelling
- Flor-grade cork handles, with powder cork reinforcement on fighting butts
- Titanium stripper guides and titanium coated, stainless steel, single leg guides
- Custom designed, hard anodised reel seats
- Polyester fabric covered polycarbonate rod tubes

Code 23A0053

Length	Line	Sections	Handle	Wt.(oz)	Price
9' 0"	#5	4	H	2.5	£599.00
9' 0"	#6	4	I	2.8	£599.00
10' 0"	#7	4	J	3.8	£749.00
12' 9"	#8/9	6-TV	K	6.2	£939.00
13' 9"	#8/9	6-TV	K	7.1	£999.00
13' 9"	#9/10	6-TV	K	7.2	£999.00
14' 9"	#9/10	6-TV	K	8.2	£1099.00

Additional sizes are available please visit www.sportfish.co.uk or call 01544 327111 for more information.



Wychwood Drift Fly Rods

This Drift range of Wychwood rods has been designed specifically for the modern river angler. These slim, lightweight rods are produced using super-fine grades of Toray carbon and feature an action that suits all styles of modern river fishing.

Key Features

- Lightweight, super-thin, high modulus carbon blanks
- Non-flash, matt black finish
- Subtle rod action suitable for all styles of river fishing
- P-cork handle with a discreet camo look
- 20cm marker for competitions
- Black, anodised, cut-away aluminium reel seat
- Quality Pac Bay rings and guides

Code 17A0003

Length	Line	Sections	Handle	Wt.(oz)	Price
6'0"	#2	4	A	2.1	£129.99
7'0"	#3	4	A	2.3	£129.99
8'0"	#4	4	A	2.4	£139.99
9'0"	#3	4	A	2.8	£139.99
9'0"	#4	4	A	2.9	£139.99
9'0"	#5	4	A	3.1	£149.99
10'0"	#3	4	A	3.0	£149.99
10'0"	#4	4	A	3.3	£149.99
11'0"	#3	4	A	3.3	£149.99

Snowbee Prestige G-XS Graphene Fly Rods

Snowbee's amazing graphene technology really is a "game changer" providing incredible molecular compression and expansion properties in terms of fly rod design and performance. Graphene is the lightest physical material known and is over 200 times stronger than steel. The Snowbee Prestige G-XS is a series of rods of extreme performance.

Key Features

- Graphene: strongest, lightest material known to man
- Enormous strength and flexibility
- Incredible molecular compression and expansion properties
- Effortless extreme distance and casting accuracy
- Original Purchaser Lifetime Guarantee
- Lightweight cordura tube & cotton drill sleeve

Code 19A0077

Length	Line	Sections	Handle	Wt.(oz)	Price
8'0"	#4	4	B	2.3	£489.00
9'0"	#5	4	B	2.8	£499.00
9'0"	#6	4	B	2.9	£499.00
9'6"	#7	4	C	3.7	£529.00
10'0"	#4	4	B	3.0	£519.00
10'0"	#5	4	B	3.1	£519.00
10'0"	#6	4	C	3.2	£539.00
10'0"	#7	4	C	3.8	£549.00

Cortland Competition MKII Nymph and Lake Fly Rods

Cortland Competition MKII rods are built using high modulus, military grade carbon and resin. They have been designed by Cortland's Prostaff team with over 30 years of top level competition experience. The Nymph rods feature a downward locking reel seat to optimise the balance of the weight and the main power in the butt section. The Lake rods are powerful for long casts but light and sensitive in the tip so as not to bounce fish and they feature a comfortable fighting butt for extra control.

Key Features

- Ultra-premium grade Portuguese cork
- Single foot guides
- Stealthy unpainted finish
- Optic orange hard rod case
- Membership of Club Cortland available

Code 18A0055

Length	Line	Sections	Handle	Wt.(oz)	Price
10'0" Nymph	#2	4	D	3.3	£474.00
10'6" Nymph	#3	4	D	3.4	£474.00
11'0" Nymph	#2	4	D	3.5	£474.00
11'0" Nymph	#3	4	D	3.6	£474.00
10'0" Lake	#7	4	E	4.2	£299.00
10'0" Lake	#8	4	E	4.3	£299.00

EURO NYMPH FISHING

Euro nymphing was created to catch spooky fish in shallow, slow flowing rivers. It has now been adapted to fish fast water of up to a metre or so deep. However, the French leader is extremely versatile and can be used to fish all types of water.

The Euro nymph leader itself is made up of an extremely long tapered monofilament leader and is designed to be fished on long, soft fly rods. At the end of the tapered leader there's a short indicator piece. From the indicator you have your tippet and flies. You should vary the length of your tippet to the depth of water you're fishing: 3ft feet deep = 3ft tippet.

The important thing to remember when using a Euro nymph leader is to flick or lob the flies rather than cast. Unless you're fishing extremely long distances you rarely use fly line when fishing this method.

Snowbee Knotted Tapered French Leaders

A 12½ft – Tapers from 0.55mm down to 0.15mm (4.1lbs). 6 sections with a Hi-Viz orange indicator attached. Looped at both ends.

B 16ft – Tapers from 0.55mm down to 0.10mm (2.4lbs). 6 sections with final 2 sections in clear monofilament. Looped at both ends.

Code 17A0066
£4.99 each



RIO 2-Tone Indicator Tippet

2-Tone 8" sections of alternating fluorescent pink and chartreuse tippet with clear colour changes. The best indicator material for building nymphing indicators. 30yd spool.

Sizes: 2X (8.5lb), 3X (7lbs), 4X (6lb)

Code 17A0067
£15.99



RIO Euro Nymph Shorty Fly Line

A 20ft, ultra-thin, super-sensitive fly line with a welded loop at each end. Allows you to instantly convert your standard fly line into a specialised nymphing line by a simple loop-to-loop connection. Size #2-5.

Code 19B0022
£29.99



A Sage ESN (European Style Nymphing) Fly Rods

Designed specifically for European style nymphing techniques and developed to maximise catch rates. Please see page 11 for more information.

Code 16B0006 £995.00

B Greys Wing Streamflex Plus Nymphing Fly Rod

This 9ft 8in/10ft 8ins rod is designed with the nymph angler in mind. The removable 1ft extension piece allows the angler to easily change their rod into the perfect nymphing rod without removing the reel or line. Please see page 18 for more information.

Code 22B0015 £449.00

C Vision Nymphmaniac Fly Rods

The Nymphmaniac offers exceptional performance at a reasonable price. Super lightweight for long days on the river and with a blank that dampens immediately after your cast. The Nymphmaniac has enough power in the tip so hooking a fish is effortless but at the same time they bend enough when fighting a fish. Please see page 26 for more information.

Code 21A0008 From £399.00

Nymphing - The New Way

By Jonathan White

This is the first book to explain all branches of French leader techniques from sight nymphing to short and long-range indicator nymphing through to dry fly. Hardback with 160 pages and 150 colour photographs.

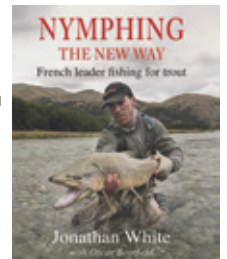

Code 16B0002 £19.99

RIO Euro Nymph Leader

11ft high-vis milky white tapered leaders, hand tied to 22ins of RIO 2-tone Indicator tippet material to give maximum visibility and make subtle strike detection easier. Tapers from 0.28mm to 0.23mm. Supplied with a tippet ring at end to add your own tippet.

Code 15B0051 £10.99

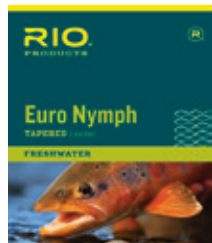

RIO Technical Euro Nymph Line

An ultra-thin, incredibly light line for the utmost in sensitivity with a monofilament core that extends past the front end of the line to become a leader, resulting in no knots to get caught in the guides. Leader is .013" in diameter and pink to be easily seen.

Code 21B0074 £74.99

GREYS
TRUST YOUR INSTINCT

Greys Fin Euro Nymph Combination Outfits

A ready-to-go combo outfit designed by current FIPS World Champion, Howard Croston, for the demands of the modern Euro nymph fisher, featuring a perfectly balanced rod, reel and low diameter nymphing line. The rod is built with a flexible tip action for casting out weighty nymphs with accuracy and feel and is paired with Greys' all new Fin fly reel. If you're thinking of taking your first steps into the world of modern river nymphing, this combo is the perfect place to start! All supplied in a convenient rod & reel travel case.

Code 21B0033

Length	Line	Sections	Price
10'0"	#3	4	£179.99
11'0"	#3	4	£199.99

FLY FISHING FOR PREDATORY SPECIES

Fly fishing for predatory species - pike, zander or perch in freshwater or for bass, pollock and mackerel in saltwater - is rapidly growing in popularity within the UK. When you can't chase trout and salmon on our rivers and lakes why not head to the coast, a local canal or secluded pike lake for some alternative but exhilarating sport?

We have put together a small selection of tackle that is ideally suited to targeting any of these species. But, as always, if you would like more detailed help or information, please give Danny or any of his team of advisors a call (01544 327 111) or call into one of our stores and we will be delighted to help you.



RIO Predator Elite Fly Line

With its short head and powerful front taper this line is designed to cast large and heavy predator flies. Also features a low-stretch core, an ultra-slick performance coating and RIO's SureFire tricolored measuring system for increased accuracy and distance control. There are 4 different densities to cover every fishing situation. Also available in a warm water version. Please see our website for more information.

Code 21A0118 £99.99

Fulling Mill Premium Sea Bass Fly Selection

10 the top bass flies chosen by expert UK bass anglers. Ideal for those heading to the coast in search of bass and perfect for any time of the year.

Code 165015 £32.35



B

C



RIO Coastal Quick Shooter XP Intermediate Fly Line

A line designed specifically for UK and general coastal conditions. The easy loading, short powerful 32ft intermediate head helps turn over large flies. Please see page 63 for more information.

Code 23A0044 £99.99



RIO Pike Leaders - 7ft 6ins

An ultra-stiff nylon leader with a powerful butt and taper design to cast large flies attached to a discreet bronze coloured supple nylon coated braided wire that you can knot. Hand tied perfection loop in the butt. Ideal for pike and other toothy species. **Sizes:** 20lb or 30lb

Code 20A0086 £10.99



A

Vision Pike Ready-To-Go Outfit

Lightweight, strong, medium-fast action, 9ft Oins #9 4-piece pike rod, aluminium reel with adjustable disc brake, backing and the latest Grand Daddy intermediate fly line. A leader, wire trace and fly clip complete the perfect predator combination.

Code 20A0054 £329.00

Greys K4STX Combination Outfit

The Greys K4STX 9ft Oins #9 rod outfit is an upgraded version of the K4ST+ outfit with a faster actioned Greys rod and an aluminium large arbor reel fitted with a Greys twin coloured weight forward (WF) floating fly line, backing and leader all supplied together in a handy travel case. Please see page 4 for more information.

Code 20B0021 £169.99

Sage Salt R8 Fly Rods

Sage's new lighter, stronger, saltwater specific, fast actioned fly rod featuring R8 technology. Please see page 12 for more information.

Code 23A0033 £1099.00



Snowbee Fly and Leader Wallet

These wallets have 100's of uses from carrying all your large saltwater or pike flies, to storing leaders or to organising your fly tying materials.

Code 90182 £21.99

Partridge Pike Tech Leader Wire

Knottable, flexible, sensitive and pliable nylon-coated 49-strand stainless steel wire. Ideal as leader wire for all toothy predators.

Please see page 78 for more information.

Code 18B0040 £10.99



ROD CARRIERS*



*All supplied in pairs

Richard Wheatley Rod Vacuum Carrier

Richard Wheatley Rod Carriers will easily attach to any vehicle and are designed to safely carry 3 or 4 rods.

Code 80178 £89.99

Vac-Rac Vacuum Standard

- Non magnetic vacuum base fits all vehicles
- Swing lever through 180° to fix/unfix
- Holds up to 4 rods
- 4" high pillar

Code 25284 £73.99

Vac-Rac Vacuum Locking

Same specification as standard model except the lever is a detachable key. Standard model – 4 rods.

Code 25284 £78.99



Vac-Rac Vacuum Professional Locking

Same specifications as the above Vac-Rac's but holds up to 8 rods.

Code 25284 £150.99

Vac-Rac Extension Pillar

Extends the Vac Rac and lifts reels away from halogen lamps etc. Ideal for bigger reels.

Code 27662 £7.99



Vac-Rac Combi Vacuum & Magnetic

- Soft plastic 6 sq ins magnetic base for steel vehicles only
- Any force on the "T" pillar produces an opposing vacuum under the centre dome
- Phenomenal adhesion, super secure hold – can't blow off
- Easily removed by hand
- Holds up to 4 rods
- 10.2cm high pillar

Code 25284 £73.99

Sumo Rod Rack

The Sumo rod rack is the best rod carrier for cars we've ever seen. Easily and securely holds at least 4 fly rods. 4 suction mounts "lever-lock" independently onto any smooth non-porous surface. Vertical pivots and ball and socket connections provide unequalled flexibility to fix onto any car. Double shock cords and locking rings lock and hold your rods securely. Supplied as a pair.

Code 12A0211 £189.99

Fishpond Quikshot Rod Holder V.2

Holds a fully assembled rod securely without hindering your casting. A side release buckle releases your rod with a pinch of the fingers.

Clips onto most Fishpond products and most other belts and packs.

Code 18A0073 £36.99



Redington FORM Practice Rod

A 2-piece 4'2" practice rod with its own unique tapered RIO fly line

- Improves your casting
- Great to safely teach beginners
- Supplied in a tube with instructions and games

Code 13A0143 £49.99



ROD CARE



C&F Design Car Rod Stand

- High density foam with three rod holder recesses
- Magnetic backing attaches to car panels
- Perfect for holding rods safely while tackling up or lurching

Code 11521 £16.99



Fishpond Lariat Gear Straps - 10"

Multi-functional and grippy gear straps that can be used for a variety of tasks including keeping rod tubes together securely and lashing equipment to vehicles and boats.

Code 21A0073 £10.99 Pair



Stonfo Magnetic Rod Holder

Magnetic clips that will attach to anything metal (car etc.) and will support a rod whilst setting up. 2 clips per pack.

Code 15A0082 £15.99



Loon Quickdraw Rod Sleeve

Store your rods fully set up, protected and ready to use.

- 3 sizes:** Single Hand – Half: 49" x 1 1/4"
Single Hand – Full: 96" x 1 1/4"
Double Hand – Half: 72" x 1 1/2"

Code 22A0026 £14.99



Rod Joint Tape

3M tape is the best tape for rod joints. It is thin, it stretches to shape and when you peel it off, it doesn't leave a residue. 19mm x 20m length.

Code 11526 £7.49



Tight Line Enterprises Magnetic Rod Guard

Holds your rod securely against a car or other metal object to prevent it blowing or being knocked over. Comes with key ring attachment loop. Recessed magnet prevents damage to paintwork.

Code 70204 £17.49



Tip Top Repair Kit

Keeps you fishing if you break your rod tip. Oversized tip rings with Hotmelt glue. Tip ring sizes: 2.2, 2.4, 2.6

Code 26554 £9.99



Smith Creek Rod Clip

An ingenious aluminium zinger & rod holder that frees up both your hands and keeps your reel out of the sand & mud.

Code 12A0310 £26.99

Sportfish Neoprene Rod Wraps

A pair of neoprene rod wraps with secure velcro closure. Ideal for carrying your rod in sections.

Code 11603 £5.99 Pair

INDOOR PRACTICE/TEACHING RODS

Orvis Practicaster Rod

A one-piece, 36" long, practice rod with a green fly line and an orange fly. Comes with multiple casting game instructions and three Velcro® "trout" targets. Ideal and safe for indoor or outdoor casting practice for all ages.

Code 20B0064 £62.99



FROM £49.99

ROD TUBES



Snowbee Hard Rod Tubes

Excellent quality cordura covered super tough rod tubes. Complete with carrying handle and zipped padded top.

Code 90171

Length	Suitable For	Price
80cm x 6cm	9ft 4-pce Rods	£26.99
80cm x 7.5cm	9ft 4-pce Rods	£31.99
83cm x 11cm	9ft 6in 4-pce Rods	£39.99
100cm x 6cm	9ft 3-pce Rods	£29.99
110cm x 6cm	10ft 3-pce Rods	£29.99
116cm x 7.5cm	14ft 4-pce Rods	£37.99



Sage Bulk Rod Tubes

These large, 15cm/6ins diameter, black ballistic nylon tubes will safely transport all your rods for your special trip. They also provide safe storage for your valuable rods when not fishing. Features include double locking zips, reinforced end caps and convenient carrying straps.

Code 15A0267

Size	Suitable For	Capacity	Price
84 x 15cm	10ft 4pc Rods	Up to 12 Rods	£84.99
122 x 15cm	15ft 4pc Rods	Up to 10 Rods	£94.99



Sage Ballistic Rod and Reel Cases

These handy black ballistic nylon cases protect your valuable rods and reels and are ideal for travel and storage. Features include double locking zips, reinforced end caps and convenient carrying straps.

Code 15A0266

Type	Length	Suitable For	Price
A Single	76cm	9ft 4pc Rods	£79.99
Single	83cm	10ft 4pc Rods	£79.99
B Spey	102cm	12ft 4pc Rods	£89.99
Spey	122cm	15ft 4pc Rods	£99.99
C Double	76cm	9ft 4pc Rods	£89.99
Double	84cm	10ft 4pc Rods	£99.99



Sportube Single Tube

Sportube cases are blow moulded from high-density polyethylene, which is incredibly strong and very lightweight.

- Carries up to 5 aluminium fly rod tubes
- Fitted with wheels for easy manoeuvring
- Padded at both ends
- Internal dimensions: W 14cm x D 141cm
- Adjustable in length from 122cm to 211cm
- Lockable for added security
- Five year warranty
- Made from recycled plastic.

Code 26544 £159.99



Patagonia Travel Rod Roll

Made from tough ripstop polyester with a sturdy internal bracing structure. Holds up to 4 fly rods.

Colour: Forge Grey

2 Sizes: S-up to 69cm, L-up to 102cm

Code F21A0262 £64.99



Wychwood Rod and Reel Cases

Super-handy for anglers who want to carry their rods and reels together set-up and ready to go. Keeps 4pc rods of up to 10ft safe with their reels attached. Supplied with a comfortable, adjustable shoulder strap.

Code 20A0118

Model	Rods & Reels	Length	Price
D Single	One	90cm	£29.99
E Double	Two	90cm	£39.99
F Quad	Four	90cm	£49.99



G

H

Simms GTS Rod and Reel Cases

Keep your favourite rods and reels together, safe and secure in solid high-density plastic covered with super-tough 1680D ballistic fabric. The generous zipped opening accommodates large saltwater reels. The case features a detachable shoulder strap, a padded centre handle and a retractable luggage tag. Suitable for rods up to 10 foot 4-piece.

Colour: Carbon **Size:** 86.3 x 15.2cm

G Single – Holds one rod and one reel **£79.99**

H Double – Holds two rods and two reels **£99.99**

Code 20B0050



Vision Travel Rod Tubes

A secure and eye-catching way to carry several rods in one tube. Each tube has a lockable double zip, carry-on handle, adjustable shoulder strap, address card pocket and protective end caps. All tubes are 10cm in diameter and there are four lengths available.

Colour: Olive

Code 20A0057

Type	Suitable For	Price
82cm x 10cm	10ft 4-pce rods	£74.99
110cm x 10cm	11ft 3-pce rods	£74.99
140cm x 10cm	16ft 4-pce rods	£89.99
160cm x 10cm	15ft 3-pce rods	£89.99



Simms GTS Rod & Reel Vault

The ultimate fishing gear carrying case with capacity for up to 6 rods up to 10ft and 8 reels all securely held in divided padded compartments.

- Durable and crush-resistant compression moulded ballistic nylon case
- Zipped interior mesh pockets to hold leaders, tippets and accessories
- Detachable and adjustable comfortable shoulder straps • Reinforced daisy chains and webbing loop for attachment to other luggage

Colour: Carbon **Size:** 83 x 23 x 15cm

Code 20B0049 £199.99



HOWARD CROSTON

Double World Fly Fishing Champion and Global Fly Product Manager at Hardy and Greys

CHOOSING A FLY REEL

There's an almost endless choice when it comes to modern fly reels, with models to suit every requirement and taste, irrespective whether you view a fly reel as an integral part of your equipment or as a piece of art that simply holds the line. I am fortunate to fish in many locations for varying species throughout the year so when choosing the right reel for the job I generally approach it in the order below.

Pick your drag system

The drag can be the single most important feature in a fly reel, or the least important depending on what you're fishing for and where. Disc drags typically offer the highest strength and the smoothest application of drag across a wide range making them ideal for chasing fish that are typically stronger, larger, or harder fighting. A disc drag can come in many forms. As a rule, fully sealed drags with carbon fibre discs are the most suitable for use in harsh saltwater environments chasing tarpon & bonefish as well as large salmon and other hard fighting species. These reels include those like the new Hardy Fortuna Regent. If you're mainly fishing in freshwater a non-sealed disc drag reel that has a lower maximum drag and by its overall design a lighter physical weight may be your best choice.

Click check reels are at the other end of the scale in terms of breaking power but are no less practical in many situations. Typically, lighter in weight and often of a more traditional design, click check reels still have many fans and thanks to their often louder 'traditional' sound and look they are particularly popular amongst salmon anglers who love to hear the raspy noise of line being taken against the click check system, as well as smaller river and stream anglers where strong drags are often not needed. Keep in mind if you need occasional 'additional' drag when using a click check reel, most have an exposed rim that allows more tension to be applied by 'palming.'

Arbor size

Large arbor reels offer many advantages and are still the preferred choice for most anglers. The large drum diameter gives faster line recovery, holds the fly line in larger, memory reducing coils and typically has a lower start up inertia and reduced 'drag gain' when a fish runs long and fast. Larger arbor reels also tend to be larger in overall diameter or hold less backing than a standard arbor reel however, most anglers favour the advantages they bring, and many have been designed to still offer the right combination of capacity vs line recovery. Standard arbor reels typically have much higher capacity and are generally smaller in overall size.

Bar stock vs Diecast

The two main materials used in fly reels are aluminium bar stock either from an ingot or bar stock forging and aluminium diecast. In general, bar stock reels tend to have a higher level of finish and design tolerance, are anodised to offer higher levels of protection, particularly in saltwater, and are generally more durable. Die-casting allows for an aluminium fly reel with many of the advantages of all metal construction at a more accessible price and offers a good performance for price compromise.

Cassette reels

Cassette reels offer huge advantage when a wide variety of fly lines are needed to ensure success. Particularly popular amongst stillwater anglers they have also found increasing favour with pike and salmon anglers in recent years as they allow the angler to easily carry a wide range of lines without much of a weight penalty. Cassette spools are generally polycarbonate or glass filled nylon and much lighter than an all-metal spool. Lower cost reels typically have a push on spool system whilst full bar stock reels like the Hardy Ultradisc Cassette feature an easy-to-use locking system.

During a normal season of fishing I will use pretty much every type of reel mentioned above and, on more than one occasion, I have been grateful for investing in the best reel for the job rather than making do with something less suitable. An adage that you often hear is that the reel does little more than 'hold line' – this is true enough at times but, if attached to the fish of the season or even a lifetime, a good quality reel that's designed for the job in hand just may help you put it in the net.

HARDY

ALNWICK | ENGLAND

Hardy Ultradisc Cassette Reels

Hardy once again raises the bar with their Ultradisc Cassette Reel, featuring a lightweight frame design, built-in line guard to protect thin running lines and a full disc drag for serious fish-stopping power. Changing spools is quick and easy thanks to the reintroduction of the popular CLS locking system. Cassette reels used to be the preserve of the stillwater and reservoir angler carrying a multitude of sinking lines, but the introduction of a #4/5 model in the range as well as a #9/10 now opens up so many possibilities for river fishers, pike fishers and salmon fishers too. Supplied in a convenient case with two additional cassette spools.

Key Features

- Bar stock aluminium frame and spool carrier
- Durable polycarbonate spool
- Our lightest high performance cassette reel
- Full disc drag
- Fast and durable spool locking system

Code **21B0025**

Model	Lines	Capacity (line/yds/lbs)	Dia.	Wt.(oz)	Reel	Spool
4000	#4/5	WF5/50/20	3.7"	6.0	£279.00	£24.99
6000	#6/7	WF7/50/20	4.1"	6.3	£299.00	£24.99
7000	#7/8	WF8/50/20	4.3"	6.6	£319.00	£24.99
9000	#9/10	WF11/150/30	4.8"	7.7	£359.00	£24.99



"Our lightest high performance cassette reel."

Bar stock aluminium frame and spool carrier

Durable polycarbonate spool

A new standard in lightweight reel design

The lightest fly reel ever produced by Hardy

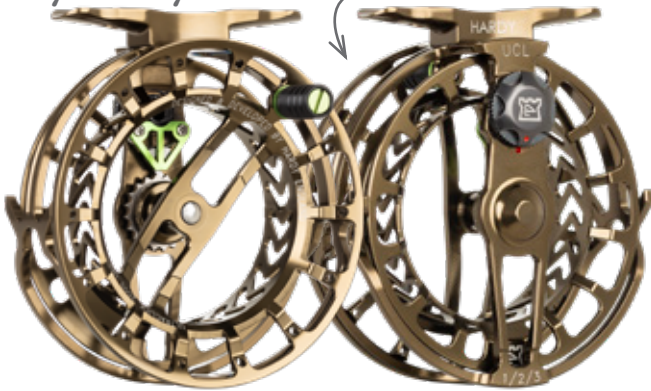

Hardy Ultraclick (UCL) Reels

The Ultraclick is Hardy's lightest ever fly reel. It features a fully enclosed line guard for use with super-thin fly lines and ESN leader-only systems. The Hardy Ultraclick is the ultimate for the light line aficionado. Fitted with an adjustable all-metal clicker drag system, this is the perfect reel for the lightest of applications.

Key Features

- A new standard in lightweight reel design
- Adjustable all-metal clicker system
- Enclosed line guard frame design for use thin fly lines
- Push off spool release
- The lightest fly reel ever produced by Hardy

Colour: Bronze

Code **20B0016**

Model	Lines	Capacity (line/yds/lbs)	Dia.	Wt.(oz)	Reel	Spool
UCL 2000	#1/2	WF2/33/20	3.1"	2.0	£249.00	£119.00
UCL 3000	#2/3	WF3/40/20	3.3"	2.2	£249.00	£119.00
UCL 4000	#3/4	WF4/45/20	3.5"	2.3	£249.00	£119.00
UCL 5000	#4/5	WF5/75/20	3.7"	2.4	£249.00	£119.00



Hardy Ultradisc (UDLA) Reels

The Hardy Ultradisc is a lightweight, large arbor disc drag reel in its purest form and is the lightest disc drag reel ever produced by Hardy. The innovative frame design allows for the use of ultra-thin fly lines and running lines as well as ESN leader-only systems. The scaled multi-pad drag system ensures strong smooth stopping power whatever your quarry.

Key Features

- Multi-pad scaled disc drag system
- Unregulated drag system for fine adjustments
- Enclosed line guard frame design
- The lightest disc drag reel ever produced by Hardy

Colours: **A** Black (*Black only available in 3000, 4000, 5000, 6000 & 7000)
B Gunmetal

Code **20B0015**

Model	Lines	Capacity (line/yds/lbs)	Dia.	Wt.(oz)	Reel	Spool
*3000	#3/4/5	WF4/45/20	3.5"	3.8	£309.00	£169.00
*4000	#4/5/6	WF5/75/20	3.7"	4.0	£309.00	£169.00
*5000	#5/6/7	WF6/80/20	3.9"	4.2	£329.00	£169.00
*6000	#6/7/8	WF7/100/20	4.1"	4.9	£329.00	£169.00
*7000	#7/8/9	WF8/115/20	4.3"	5.0	£339.00	£169.00
8000	#8/9/10	WF9/150/30	4.5"	6.4	£369.00	£189.00
9000	#9/10/11	WF10/150/30	4.8"	6.7	£399.00	£189.00
10000	#10/11/12	WF10/240/30	5.0"	7.0	£399.00	£189.00

HARDY
ALNWICK | ENGLAND



Hardy 150th Anniversary Lightweight Reels

When Hardy was looking for a special fly reel design to commemorate their 150th anniversary in 2022 they settled on the legendary 1970 Lightweight reel series as their inspiration. Made in Alnwick, England, this beautiful fly reel has been reissued with a nickel silver double screw line guide commemoratively engraved with the dates 1872-2022. The design also features a raised spindle casting and comes presented in a collectible leather reel case.

We have managed to secure a limited number of these exceptional anniversary reels that are both a true classic in fly reel design and a special gift for the angler who has everything.

Key Features

- Made in Alnwick, England
- Celebrating 150 years of the Hardy brand
- Manufactured in bar stock aluminium
- Classic two screw line guard
- Commemorative engraving
- Supplied in a soft leather reel case
- Fast and durable spool locking system

Code 21B0024

Model	Lines	Capacity (line/yds/lbs)	Dia.	Wt. (oz)	Reel	Spool
Flyweight	#2/3	WF2/33/20	2.6"	2.9	£419.00	£139.00
Featherweight	#3/4	WF3/33/20	2.9"	3.6	£479.00	£139.00
LRH	#4/5	WF4/55/20	3.1"	4.0	£479.00	£159.00
Princess	#5/6	WF5/66/20	3.5"	4.6	£479.00	£159.00
St. Aiden	#7/8	WF7/153/30	3.7"	5.6	£539.00	£169.00
St. Andrew	#8/9	WF9 Spey/219/30	4.1"	8.0	£599.00	£169.00



“Celebrating 150 years of the Hardy brand.”

Commemorative engraving

Classic two screw line guard

Modified porting to reduce weight



Hardy Marquis LWT Reels

A re-modelled classic Hardy fly reel made in Alnwick, England. This reel features numerous improvements including subtle updating of the classic style with an indented regulator button, increased porting and improved regulation range. A full range of 8 sizes available from small trout to big salmon.

Key Features

- Bar stock 6061 construction
- Improved range of adjustment
- Modified porting to reduce weight
- Indented regulator button

Colour: Gunmetal

Code 16B0015

Model	Lines	Capacity (line/yds/lbs)	Dia.	Wt. (oz)	Reel	Spool
2/3	#2/3	WF3/22/20	2.6"	3.2	£299.00	£129.00
4	#4	WF4/30/20	2.8"	3.4	£299.00	£129.00
5	#5	WF5/40/20	3.0"	3.8	£319.00	£129.00
6	#6	WF6/45/20	3.3"	4.3	£329.00	£159.00
7	#7	WF7/67/20	3.5"	4.6	£329.00	£169.00
SAL 1	#9/10	WF10/170/30	3.9"	8.1	£339.00	£189.00
SAL 2	#10/11	WF11/280/30	4.1"	9.3	£349.00	£189.00
SAL 3	#11/12	WF12/400/30	4.1"	9.9	£369.00	£199.00

Classic click check ratchet sound

Strong, smooth disc drag on salmon sizes



Made in Alnwick, England

Hardy Cascapedia UK Reels

Available in four sizes covering every freshwater application from trout to two handed Spey. The Cascapedia reel is a stunning addition to the "Hardy Made in England" reel series. The two smaller sizes feature a classic click check system whilst the two larger salmon models feature a fully functioning strong, smooth, disc drag with an inbuilt audible clicker to give the classic Cascapedia sound.

Key Features

- Made in Alnwick, England
- Strong, smooth disc drag on salmon sizes
- Full bar stock aluminium construction
- 'S' shaped handle
- Classic click check ratchet sound

Code 17B0001

Model	Lines	Capacity (line/yds/lbs)	Dia.	Wt. (oz)	Reel	Spool
3" Trout	#4/5	WF5/75/30	3.0"	6.3	£569.00	-
3½" SeaTrout	#6/7	WF7/85/30	3.5"	8.4	£599.00	-
3¾" Salmon	#8/9	WF9/190/30	3.75"	12.7	£649.00	-
4" Salmon	#10/11	WF11/290/30	4.0"	14.0	£679.00	-

The ultimate classic reel for use on bamboo or retro glass rods



Hardy Narrow Spool Perfect Reels

Relaunch of a British classic! Hardy's classic Narrow Spool Perfect reel is hand made in Alnwick, England and has been reintroduced on a limited time basis only. Each reel is fitted with a hand specific, polished rotating line guard. These reels are available in either left or right hand configurations.

Key Features

- Classic Narrow Spool Perfect
- Rotating polished line guard
- The ultimate classic reel for use on bamboo or retro glass rods
- Available for a limited time only
- Hand made in Alnwick, England
- Available in both LHW/RHW options

Code 20B0018

Model	Lines	Capacity (line/yds/lbs)	Dia.	Wt.(oz)	Reel	Spool
2 7/8" LHW	#3/4	WF4/60/20	2 7/8"	5.3	£819.00	-
3 1/8" LHW	#4/5	WF5/75/20	3 1/8"	5.7	£819.00	-
2 7/8" RHW	#3/4	WF4/60/20	2 7/8"	5.3	£819.00	-
3 1/8" RHW	#4/5	WF5/75/20	3 1/8"	5.7	£819.00	-

Saltwater safe, non-flash, anodised finish



Hardy Zane Carbon Reels

The Hardy Zane Carbon Reel is designed and made specifically for the saltwater flats angler with a non-flash, barstock 6061 aluminium and carbon frame with a saltwater safe, anodised finish. The Zane Carbon is a lightweight, large arbor reel with a sealed disc drag capable of handling anything that is thrown at it. The regulated hard indent, super-strong, silky-smooth drag system allows accurate drag settings to be applied quickly in the heat of battle. The Zane is perfectly at home taming bonefish, permit, tarpon and even giant GTs, and works perfectly as a quality salmon reel.

Key Features

- Aluminium and carbon frame
- Saltwater safe, non-flash, anodised finish
- Fully sealed multi-pad disc drag with up to 10lb+ stopping power
- 340° regulated drag control with hard indents for fast accurate adjustments

Code 20B0017

Model	Lines	Capacity (line/yds/lbs)	Dia.	Wt.(oz)	Reel	Spool
6000	#6/7/8	WF8/200/20	4.0"	8.3	£399.00	£199.00
8000	#8/9/10	WF9/290/30	4.3"	8.8	£424.00	£199.00
10000	#10/11/12	WF12/250/30	4.6"	10.5	£454.00	£199.00
12000	#12+	WF12/400/30	5.0"	11.4	£514.00	£199.00



Made in Alnwick, England

Hardy Bros Wide Spool Perfect Reels

The latest revision of a beautiful classic fly reel featuring a wide spool for better capacity, a time proven check system, and that classic Hardy Perfect sound. Easily changed from left to right hand wind. Supplied in a soft leather, sheepskin lined reel pouch. Handmade by Hardy Bros craftsmen in Alnwick, England.

Code 12A0263

Model	Lines	Capacity (line/yds/lbs)	Dia.	Wt.(oz)	Reel	Spool
2 7/8"	#3-4	WF4/60/20	2.9"	5.3	£569.00	£79.00
3 1/8"	#5-6	WF6/60/20	3.1"	5.7	£599.00	£86.00
3 3/8"	#7-8	WF8/75/20	3.4"	6.2	£569.00	£86.00
3 7/8" Taupo	#8-9	WF9/155/20	3.9"	9.9	£649.00	£89.00
4"	#9-10	WF10/250/30	4.0"	11.0	£679.00	£105.00
4 1/4"	#10-11	WF12/265/30	4.2"	11.3	£729.00	£105.00

Carbon fibre disc drag system



Hardy Fortuna Regent Fly Reels

A multi-pad carbon fibre disc drag system housed within a sealed, waterproof hub design offers the highest level of sealing yet seen on a Hardy fly reel. Drag is adjusted via a tensioned regulator while the large arbor spool delivers exceptional line pick up and the narrow spool profile ensures easy level line stacking. Flawless saltwater reliability.

Key Features

- Sealed, waterproof, carbon fibre multi-pad disc drag system
- Large arbor design with a narrow spool profile
- One-turn, positive, straight drag adjustment with defined clicks
- High power drag system delivering between 10lb & 20lb of top end drag
- Supplied in a neoprene reel pouch

Colours: **A** Silver **B** Black

Code 22B0016

Model	Lines	Capacity (line/yds/lbs)	Dia.	Wt.(oz)	Reel	Spool
8000	#7/8/9	WF9/175/30	4.5"	8.7	£599.00	£219.00
10000	#9/10/11	WF11/200/30	5.1"	9.9	£649.00	£239.00
12000	11+	WF12/250/30	5.5"	11.4	£699.00	£249.00





Sage ENFORCER Reels

Fine-tuned for greater power, reliability and durability and designed with peak performance in mind, the ENFORCER offers everything the saltwater flats angler needs in a reel. With beefed up O-rings and drag plates for added durability, consistency and reliability, they've also upped the maximum drag - you'll find eight pounds of drag in the 7/8 size, 15 pounds in the 9/10 size and 17 pounds in the 11/12 size.

Key Features

- Ultra-robust Sealed Carbon System (SCS) drag with larger drag discs to better disperse pressure
- One revolution drag knob with detented settings
- Large concave arbor for faster line pick-up, greater strength and increased capacity
- All-new reel foot design with radiused corners to prevent abrasion to leaders
- Fully machined 6061-T6 aerospace grade aluminium with a hard anodised surface
- Large ergonomic handle
- Quick-change spool mechanism

Colours: **A** Granite **B** Tempest Blue **Code 23A0034**

Model	Lines	Capacity (line/yds/lbs)	Dia.	Wt.(oz)	Reel	Spool
7/8	#7-8	WF8/200/20	4.2"	9.4	£575.00	£289.00
9/10	#9-10	WF10/200/30	4.6"	10.8	£575.00	£289.00
11/12	#11-12	WF12/300/30	4.9"	11.9	£575.00	£289.00

Sealed Carbon System (SCS) drag



Sage ARBOR XL Reels

With an extra-large arbor for ultra-fast line retrieval and a narrow spool that makes level-winding effortless, these fully machined technical reels are built for taming fast fish. They feature Sage's Sealed Carbon System (SCS) drag system, tuned for optimum performance in each size class and a one revolution drag knob for reliable and repeatable pressure. Designed for those looking to gain every advantage in the most critical of situations.

Key Features

- Ultra-large arbor for fast line pick-up
- Fully machined 6061-T6 aerospace grade aluminium
- Hard anodised for surface protection and corrosion resistance
- Sealed Carbon System drag (SCS) drag
- One revolution drag knob with 20 numbers and 39 indented settings
- Concave, ported large arbor for greater strength and capacity
- Comfortable ergonomic handle
- Easy conversion from left to right hand retrieve
- Secure neoprene and ballistic nylon reel case

Colours: **C** Frost **D** Slate **Code 22A0108**

Model	Lines	Capacity (line/yds/lbs)	Dia.	Wt.(oz)	Reel	Spool
4/5/6	#4/5/6	WF6/100/20	4.1"	4.4	£449.00	£225.00
6/7/8	#6/7/8	WF8/200/20	4.5"	6.5	£475.00	£237.00

Quick-change spool mechanism



Ergonomic handle

Sage SPECTRUM LT Reels

The lightweight Sage SPECTRUM LT reels feature a high-performance drag system with an ultra-light fully machined aerospace aluminium frame. The Sealed Carbon System (SCS) drag together with the One Revolution drag knob offers quick and precise drag settings and provides the kind of power and smoothness you'd expect from a large traditional drag system, only without the bulk or weight.

Key Features

- Sealed Carbon System (SCS) drag
- One revolution drag knob with numbered and indented settings
- Concave, ported large arbor for greater strength and capacity
- Hard anodised for surface protection and corrosion resistance
- Ergonomic handle
- Quick-change spool mechanism
- Easy conversion from left- to right-hand retrieve
- Neoprene and ballistic nylon reel case

Colours: **E** Silver Pine (To match Sage R8 Rods) **F** Black Spruce (To match Sage X Rods) **Code 17B0008**

Model	Lines	Capacity (line/yds/lbs)	Dia.	Wt.(oz)	Reel	Spool
3/4	#3/4	WF4/100/20	3.2"	3.8	£399.00	£199.00
4/5	#4/5	WF5/100/20	3.5"	4.0	£399.00	£199.00
5/6	#5/6	WF6/100/20	3.6"	4.2	£399.00	£199.00
7/8	#7/8	WF8/200/20	4.0"	6.0	£425.00	£212.00
9/10	#9/10	WF10/200/30	4.3"	7.1	£425.00	£212.00



Sealed Carbon System (SCS) drag

Sage SPECTRUM Reels

The fully machined Sage SPECTRUM is a true large arbor performance fly reel. The Sage SPECTRUM is extremely durable and packed with features you'd expect on higher priced reels such as a concave spool surface for optimal line capacity and drag-assisting smoothness with Sage's proven Sealed Carbon System (SCS) drag.

Key Features

- Sealed Carbon System (SCS) drag
- One Revolution drag knob with numbered and indented settings
- Concave, ported large arbor for greater strength and capacity
- Hard anodised for surface protection and corrosion resistance
- Aluminium ergonomic handle
- Quick-change spool mechanism
- Easy conversion from left- to right-hand retrieve
- Neoprene and ballistic nylon reel case

Colour: Platinum

Code 17B0009

Model	Lines	Capacity (line/yds/lbs)	Dia.	Wt.(oz)	Reel	Spool
3/4	#3/4	WF4/100/20	3.2"	4.1	£299.00	£149.00
5/6	#5/6	WF6/100/20	3.6"	4.3	£299.00	£149.00
7/8	#7/8	WF8/200/20	4.0"	6.3	£325.00	£162.00
9/10	#9/10	WF10/200/30	4.3"	7.6	£325.00	£162.00



Sage CLICK Reels

Sage's CLICK reels strike a perfect balance between the traditional click and pawl style reels with cutting edge technology, innovative design, and minimal weight. The model features a refreshed modern design but keeps the original proven adjustable click drag.

Key Features

- Anti-glare bronze finish
- Adjustable click and pawl drag
- Ultra-large arbor
- Easy conversion from left- to right-hand retrieve

Colour: Bronze

Code 15B0060

Model	Lines	Capacity (line/yds/lbs)	Dia.	Wt.(oz)	Reel	Spool
0/1/2	#0-2	WF2/75/20	3.1"	2.3	£329.00	£165.00
3/4/5	#3-5	WF5/100/20	3.4"	2.6	£329.00	£165.00
4/5/6	#4-6	WF6/100/20	3.7"	3.0	£329.00	£165.00

One revolution drag knob with numbered and indented settings



Sage TROUT Reels

The Sage TROUT reel is a modern reel that features traditional classic styling with a full-frame design, narrow profile and Sage's proven one revolution, Sealed Carbon System (SCS) drag for smooth, strong stopping power. The Sage TROUT reel also features a machined aluminium full frame with minimal porfing for a classic look and a machined and anodised aluminium drag hub and ergonomic handle.

Key Features

- Sealed Carbon System (SCS) drag
- One revolution drag knob with numbered and indented settings
- Large arbor for fast line pick-up
- Concave arbor for greater strength and capacity
- Easy conversion from left- to right-hand retrieve
- Neoprene and embroidered ballistic nylon reel case

Colour: Bronze

Code 20A0051

Model	Lines	Capacity (line/yds/lbs)	Dia.	Wt.(oz)	Reel	Spool
2/3/4	#2-4	WF4/100/20	3.2"	4.7	£399.00	£199.00
4/5/6	#4-6	WF6/100/20	3.5"	5.4	£399.00	£199.00
6/7/8	#6-8	WF8/150/20	3.8"	7.1	£425.00	£212.00

Vented concave arbor for greater strength and capacity



Sage SPECTRUM C Reels

The Sage SPECTRUM C reels feature a large arbor, vented, concave spool with a rugged, lightweight, aluminium, die-cast frame with a machined finish. Equipped with the same SPECTRUM family, one revolution, Sealed Carbon System (SCS) drag and unexpected finishing touches like a fully machined drag knob and an ergonomic handle. The powder coated surface offers both protection and corrosion resistance.

Key Features

- Sealed Carbon System (SCS) drag
- One revolution drag knob with numbered and indented settings
- Large arbor for fast line pick-up
- Vented concave arbor for greater strength and capacity
- Easy conversion from left- to right-hand retrieve
- Neoprene and embroidered ballistic nylon reel case

Colours: A Grey B Black

Code 18B0009

Model	Lines	Capacity (line/yds/lbs)	Dia.	Wt.(oz)	Reel	Spool
3/4	#3/4	WF4/100/20	3.3"	4.6	£165.00	£82.00
5/6	#5/6	WF6/100/20	3.6"	4.9	£165.00	£82.00
7/8	#7/8	WF8/200/20	4.0"	6.2	£185.00	£92.00
9/10	#9/10	WF10/200/30	4.3"	7.5	£185.00	£92.00



Sage ESN Reel

Euro-nympers look no further, the Sage ESN reel has been designed especially for you! The Sage ESN is built on a super lightweight and large arbor design, enabling you to minimise line tangles and get fish straight onto the reel quickly. A unique balance system with moveable weights also allows you to balance this beauty of a reel with the nymphing rod of your choice - genius! Supplied with 3 weights: 1/2oz, 1oz and 1 1/2oz.

Key Features

- Full frame design prevents the trapping of low diameter tippet
- Sealed carbon drag
- Ultra large arbor for fast line pickup
- Stainless steel adjustable balance weights
- Easily converted to right or left hand wind
- Fully machined aerospace grade anodised aluminium

Colours: C Chipotle D Stealth

Code 20A0164

Model	Lines	Capacity (line/yds/lbs)	Dia.	Wt.(oz)	Reel	Spool
ESN Euro Nymph	Euro Nymph	Euro Nymph/75/20	3.9"	4.9	£449.00	£225.00



Available as a 3-Pack containing a reel and two additional spare spools

Lamson Liquid Reels

A pressure cast aluminium reel that offers incredible performance and value for money and which utilises the same super smooth, strong drag found in all Lamson reels. The Liquid is available either as a single reel or as a pack containing a reel and two additional spare spools offering a huge saving.

Key Features

- Large arbor
- Pressure cast aluminium frame and spool
- Full radius compound curves, near zero-radius inside corners
- Sealed conical drag

Colour: Smoke

Code 20A0007

Super smooth, strong drag found in all Lamson reels

Quality, pressure cast reel that offers incredible performance and value for money

Model	Lines	Capacity (line/yds/lbs)	Dia.	Wt.(oz)	Reel	Spool
-3+	#2-4	WF4/100/20	3.3"	4.2	£149.99	£63.99
-5+	#4-6	WF6/100/20	3.6"	4.6	£149.99	£63.99
-7+	#6-8	WF8/200/20	3.8"	5.2	£159.99	£73.99
-9+	#8-10	WF10/250/30	4.6"	6.7	£169.99	£84.99

Model	Lines	Capacity (line/yds/lbs)	Dia.	Wt.(oz)	3-Pack	Spool
3-Pack -3+	#2-4	WF4/100/20	3.3"	4.2	£239.00	-
3-Pack -5+	#4-6	WF6/100/20	3.6"	4.6	£239.00	-
3-Pack -7+	#6-8	WF8/200/20	3.8"	5.2	£269.00	-
3-Pack -9+	#8-10	WF10/250/30	4.6"	6.7	£289.00	-



Scientific Anglers Mastery MPX Fly Line
SEE PAGE 56



Scientific Anglers Frequency Trout Fly Line
SEE PAGE 56

Lamson Remix Reels

A hybrid of a Computer Numerical Control (CNC) machined, lightweight aluminium frame and a pressure cast spool. The result is the ultimate blend of high performance, reliability and quality. It utilises the same super smooth, strong drag found in all Lamson reels. The Heavy Duty (HD) version features an all-enclosed spool design. Available either as a single reel or as a pack containing a reel and 2 spare spools.

Key Features

- Large u-shaped arbor
- Machined aluminium frame & pressure cast aluminium spool
- Full radius compound curves, near zero-radius inside corners
- Sealed conical drag system

Colour: Smoke

Code 20A0006



Available either as a single reel or as a pack containing a reel and 2 spare spools



Machined & pressure cast aluminium with stainless steel

The Remix utilises the same super smooth, strong drag found in all Lamson reels

Model	Lines	Capacity (line/yds/lbs)	Dia.	Wt.(oz)	Reel	Spool
-3+	#2-4	WF4/100/20	3.3"	4.3	£249.00	£63.99
-5+	#4-6	WF6/100/20	3.6"	4.6	£249.00	£63.99
-7+	#6-8	WF8/200/20	3.8"	5.5	£269.00	£73.99
HD-7+	#6-8	WF8/200/20	4.0"	6.4	£269.00	£73.99
HD-9+	#8-10	WF10/250/30	4.8"	8.3	£289.00	£84.99

Model	Lines	Capacity (line/yds/lbs)	Dia.	Wt.(oz)	3-Pack	Spool
3-Pack -3+	#2-4	WF4/100/20	3.3"	4.3	£319.00	-
3-Pack -5+	#4-6	WF6/100/20	3.6"	4.6	£319.00	-
3-Pack -7+	#6-8	WF8/200/20	3.8"	5.5	£349.00	-
3-Pack HD-7+	#6-8	WF8/200/20	4.0"	6.4	£359.00	-
3-Pack HD-9+	#8-10	WF10/250/30	4.8"	8.3	£379.00	-



Lamson Litespeed LSF 'Fresh' Reels

The LSF is the freshwater version of the new Litespeed. Thanks to the spool and frame being 'super-arbor' in scale, it offers the quickest retrieve rate of any Waterworks Lamson reel, while also reducing weight. The chassis is based on Lamson's successful conical system, with the addition of a click stop drag knob and a unique spring system that creates a smooth and very fine adjustability at the light end of its range.

Key Features

- Ultra-large arbor format
- Space frame construction with exceptional strength to weight ratio
- Indexing click drag knob

Colour: Fuego

Code 21A0049

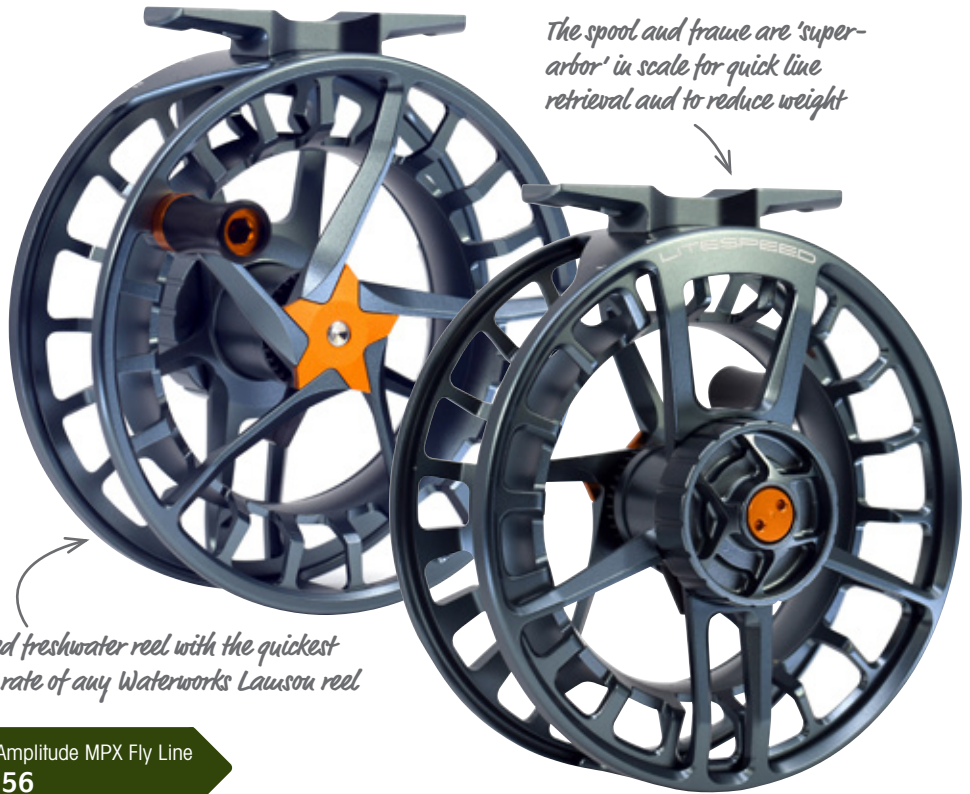

The spool and frame are 'super-arbor' in scale for quick line retrieval and to reduce weight

Litespeed freshwater reel with the quickest retrieve rate of any Waterworks Lamson reel



Scientific Anglers Amplitude MPX Fly Line
SEE PAGE 56

Model	Lines	Capacity (line/yds/lbs)	Dia.	Wt.(oz)	Reel	Spool
LSF-3+	#2-4	WF4/75/20	3.5	3.1	£569.00	£299.00
LSF-5+	#4-6	WF6/125/20	3.7	3.6	£569.00	£299.00
LSF-7+	#6-8	WF8/180/20	4.0	4.5	£609.00	£319.00



Scientific Anglers Mastery MPX Fly Line
SEE PAGE 56

Fully waterproof (IPX8) sealed drag designed for fighting powerful fish in saltwater

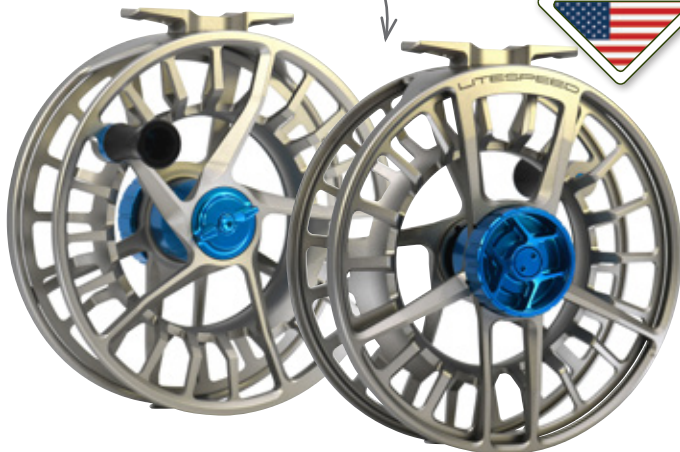

Lamson Litespeed LSM 'Marine' Reels

The LSM is the saltwater version of the Lamson Litespeed reels, equipped with a hybrid fully waterproof sealed drag designed for fighting powerful fish in saltwater. Thanks to the spool and frame being 'super-arbor' in scale, it offers a super quick retrieve rate, while also reducing weight, with an emphasis on greater stiffness and stability.

Key Features

- Ultra-large arbor format
- Space frame construction with exceptional strength to weight ratio
- Indexing click drag knob
- Linear progression drag springs for predictable drag tension

Colour: Riviera

Code 21A0048

Model	Lines	Capacity (line/yds/lbs)	Dia.	Wt.(oz)	Reel	Spool
LSM8	#8-9	WF8/250/20	4.6	5.5	£739.00	£369.00
LSM10	#10-11	WF10/250/30	4.8	6.5	£779.00	£389.00
LSM12	#12-13	WF12/300/30	5.1	8.0	£819.00	£409.00



Large arbor format



Lamson Centerfire HD Reels

A double-edged sword perfectly suited for both single and double handed fly fishing for Atlantic salmon and sea trout in torrential rivers, as well as adrenaline-choked sight-fishing on shimmering saltwater flats. Built to blend the strongest and most reliable structural and functional elements from over a quarter century of reel design. A bullet proof workhorse of a reel, with everything you need and nothing you don't.

Key Features

- IPX8 certified waterproof cobalt hybrid drag system with large format drag cone
- Carbon PEEK thrust washers with custom self-lubricating O-ring seals
- Large easy grip drag knob and oversized handle
- Locking spool nut and integrated counterbalance
- Signature Power Arm frame and deep cross section radial spool spokes
- Hard anodised machined aluminium and stainless steel

Colour: Eclipse **Code 23A0002**

Model	Lines	Capacity (line/yds/lbs)	Dia.	Wt.(oz)	Reel	Spool
8	#7-8	WF8/250/20	4.0"	6.7	£559.00	£289.00
10	#9-10	WF10/250/30	4.3"	7.8	£609.00	£309.00
12	#11-12	WF12/300/30	4.7"	8.9	£659.00	£329.00

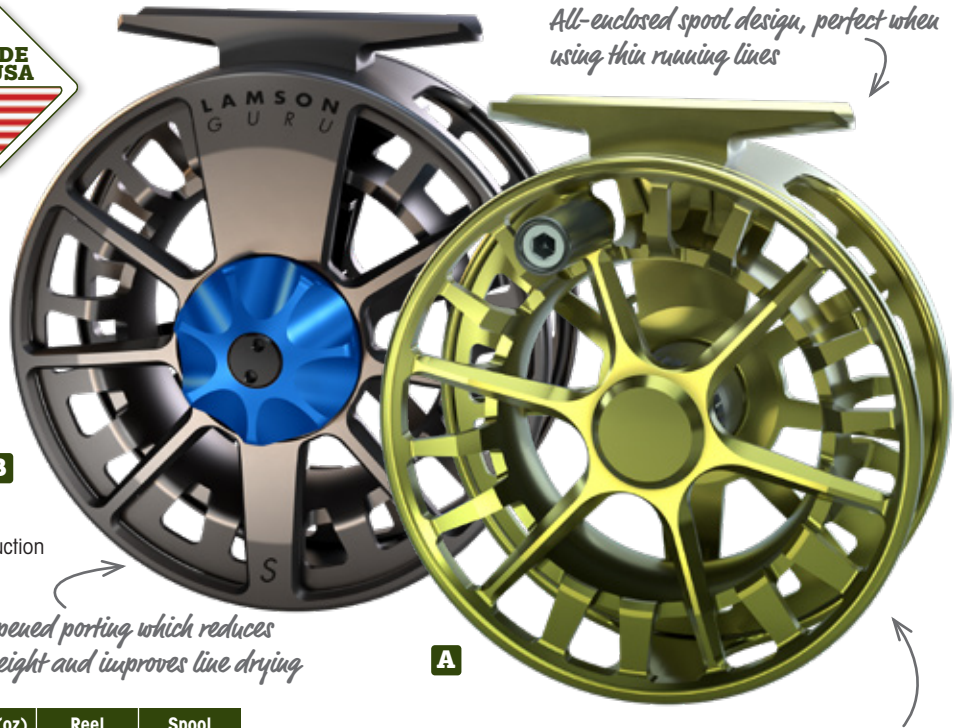

All-enclosed spool design, perfect when using thin running lines

B

A

Opened porting which reduces weight and improves line drying

Integrated counterbalance and curved cross section arbor increases the strength of the reels while reducing their weight

Lamson Guru S Reels

Lamson's lowest priced fully machined reel is now in its third generation, with updated spool geometry for better retrieve rates, open porting to reduce weight and improve line drying and an integrated counterbalance for structural stability. The Heavy Duty (HD) versions are great affordable saltwater or Spey reels and have an all-enclosed spool design, perfect when using thin running lines.

Key Features

- Large arbor format
- Machined 6061 aluminium and stainless steel construction
- Sealed conical drag system

Colours: **A** Olive Green **B** Artic Blue

Code 20A0008

Olive Green **not** available in HD-7+ and HD-9+

Artic Blue **only** available in HD-7+ and HD-9+

Model	Lines	Capacity (line/yds/lbs)	Dia.	Wt.(oz)	Reel	Spool
-3+	#2-4	WF4/60/20	3.2"	3.7	£319.00	£179.99
-5+	#4-6	WF6/100/20	3.6"	4.4	£319.00	£179.99
-7+	#6-8	WF8/180/20	4.0"	5.0	£359.00	£189.99
-9+	#8-10	WF10/220/30	4.1"	5.8	£379.00	£199.99
HD-7+	#6-8	WF8/180/20	4.0"	5.3	£419.00	£189.99
HD-9+	#8-10	WF10/220/30	4.1"	6.1	£449.00	£199.99



Scientific Anglers Mastery ART Fly Line
SEE PAGE 56



Lightest machined fly reel on the market

Lamson Speedster S Reels

The completely redesigned Lamson Speedster S reels feature an enhanced spool machining technique, focusing material only where it's needed, and resulting in reels that are significantly lighter and higher performing. The super-sized arbor, narrower spool and inboard mounted handle allow for super-quick line pick up and retrieval.

Key Features

- Super-sized arbor format
- Machined 6061 aluminium and stainless steel construction
- Sealed conical drag system

Colour: Midnight

Code 20A0009

Model	Lines	Capacity (line/yds/lbs)	Dia.	Wt.(oz)	Reel	Spool
-3+	#2-4	WF4/50/20	3.3"	3.3	£419.00	£219.00
-5+	#4-6	WF6/100/20	3.6"	3.8	£419.00	£219.00
-7+	#6-8	WF8/180/20	4.0"	4.7	£459.00	£229.00
-9+	#8-10	WF10/220/30	4.3"	5.7	£509.00	£249.00

Lamson Force SL Series II Reels

The lightest machined fly reel on the market, featuring an even larger arbor than its predecessor for the highest possible retrieve rate to reel weight ratio. Plus an enhanced CNC machined structural development and more fluid, refined styling. While other super-arbor reels add weight in order to gain speed, Force series reels maintain their featherweight specification by being pure muscle.

Key Features

- Super-sized arbor format
- Machined 6061 aluminium and stainless steel construction
- Sealed conical drag system

Colour: Thermal orange

Code 20A0010

Model	Lines	Capacity (line/yds/lbs)	Dia.	Wt.(oz)	Reel	Spool
-5+	#4-6	WF6/125/20	4.1"	3.3	£639.00	£299.00
-7+	#6-8	WF8/180/20	4.4"	3.7	£659.00	£319.00

ORVIS®

Sealed and maintenance free, super-strong drag system

Orvis Hydros Reels

The Orvis Hydros reels feature a large arbor design for quick line retrieval. The strong, smooth sealed carbon and stainless-steel drag is more than twice as powerful as its predecessor with zero start up inertia. The fully machined aluminium frame has also been redesigned to be lighter and stronger and to balance better with lighter rods.

Key Features

- Large arbor design
- Sealed and maintenance free, super-strong drag system
- Fully machined, strong, lightweight and anodised aluminium frame
- Comfortable, asymmetric drag knob with a positive click

Colours: **A** Black **B** Silver

Code **20A0044**

Fully machined, strong, lightweight and anodised aluminium frame



Comfortable, asymmetric drag knob with a positive click

Model	Lines	Capacity (line/yds/lbs)	Dia.	Wt.(oz)	Reel	Spool
II	#3-4	WF4/125/20	3.4"	5.0	£270.00	£145.00
III	#5-6	WF6/125/20	3.7"	5.5	£295.00	£150.00
IV	#7-8	WF8/200/20	4.0"	6.6	£305.00	£160.00
V	#9-11	WF10/225/30	4.2"	7.7	£325.00	£170.00

Orvis Clearwater Rods
SEE PAGE 27

SPORTFISH RECOMMENDED

Lightweight, fully machined and Type II anodised aluminium frame



Easy spool change and LHW/RHW conversion

Orvis Battenkill Disc Reels

The mid-arbor, Battenkill Disc Reel is true to its heritage in looks but is updated with the latest in design features and a significantly more powerful disc drag.

Key Features

- Powerful, smooth, fully sealed and stacked disc drag
- Lightweight, fully machined and Type II anodised aluminium frame
- Comfortable Delrin power handle
- Easy spool change and LHW/RHW conversion

Colour: Black Nickel

Code **17A0006**

Model	Lines	Capacity (line/yds/lbs)	Dia.	Wt.(oz)	Reel	Spool
II	#3-5	WF4/125/20	3.0"	4.6	£189.00	£89.00
III	#5-7	WF6/100/20	3.2"	4.9	£199.00	£95.00
IV	#7-9	WF8/200/20	3.5"	5.9	£209.00	£105.00

Ultra-lightweight design



Black nickel finish with laser engraved logos

Orvis Battenkill S&P Reels

Simplistic design and flawless construction make this the perfect reel for nearly any freshwater fishing situation. A minimalist's dream, an ultra-lightweight design balances perfectly on shorter rods.

Key Features

- Classic click-and-pawl drag system, ideal for using palm control when playing fish
- Narrow spool reduces line stacking
- Machined from heavy-duty bar stock aluminium for added durability
- Black nickel finish with laser engraved logos

Colour: Black Nickel

Code **13A0145**

Model	Lines	Capacity (line/yds/lbs)	Dia.	Wt.(oz)	Reel	Spool
I	#1-3	WF2F/75/20	2.7"	2.8	£135.00	£73.00
II	#3-5	WF4F/75/20	3.0"	2.9	£145.00	£79.00
III	#5-7	WF6F/100/20	3.2"	3.2	£155.00	£85.00



“New standard in performance fly reels at an affordable price”



Greys FIN Reels

The Greys FIN reels set a new standard in performance fly reels at an affordable price. The FIN is a performance reel in a never-before-seen die-cast construction. The FIN is constructed from durable injection moulded aluminium that undergoes two unique machining processes to perfect and polish it to a stunning multi-colour finish. The reels are fitted with a full rulon disc brake system that provides a sturdy smooth drag. The fully enclosed frame prevents line escape and is designed with a large arbor spool for rapid retrieve and line care. A family of four sizes will cover all your needs.

Key Features

- High quality die-cast, machine finished construction
- Full rulon disc drag system
- Modern large arbor design for quick line retrieve
- Simple left hand to right hand conversion
- Supplied with in a convenient reel pouch

Code 21B0032

Model	Lines	Capacity (line/yds/lbs)	Dia.	Wt.(oz)	Reel	Spool
3/4	#3/4	WF4/50/20	3.3"	5.7	£62.99	£31.99
5/6	#5/6	WF6/50/20	3.8"	6.3	£69.99	£31.99
7/8	#7/8	WF7/75/20	4.2"	6.9	£74.99	£36.99
9/10	#9/10	WF10/150/30	4.4"	8.6	£84.99	£42.99



Greys FIN Cassette Reels

The Greys FIN Cassette fly reel is the perfect solution for the angler looking to cover multiple options with just one reel. Over the years Greys has led the revolution in cassette fly reels and the FIN Cassette is their latest addition and is no exception. Part of the all-new Greys design concept with its cutting-edge large arbor design, it is perfectly balanced with a well proven rulon disc drag system in a range of three sizes to cover all species.

Key Features

- High quality die-cast, machine finished construction
- Full rulon disc drag system
- Durable cassette spool
- Modern large arbor design for quick line retrieve
- Simple left-hand to right-hand conversion
- Supplied with in a convenient carry case with two spare cassettes

Code 21B0032



Greys Kite Rods
SEE PAGE 19



Model	Lines	Capacity (line/yds/lbs)	Dia.	Wt.(oz)	Reel	Spool
5/6 Cassette	#5/6	WF6/50/20	3.8"	7.2	£84.99	£10.59
7/8 Cassette	#7/8	WF7/75/20	4.2"	7.9	£94.99	£10.59
9/10 Cassette	#9/10	WF10/150/30	4.4"	10.0	£104.99	£10.59



High quality die cast, machine finished construction

Carbon disc drag system

Modern large arbor design



Greys Tail Reels

A new standard in die-cast reel design, the latest addition to the Greys reel family is constructed from durable die-cast aluminium which undergoes two separate machining processes to create a stunning, highly finished design. Fitted with a carbon disc drag, the Tail reels feature a smooth and dependable sealed drag, enclosed frame design to prevent line escape and a rapid retrieve large arbor design spool.

The "All Water" (7/8 and 9/10) models are finished with an anodising pre-treatment and then a durable paint finish to ensure corrosion-free saltwater use. The Tail All Water is also fitted with a sealed disc drag system generating over 10lbs of smooth drag, a feature usually found in reels costing twice the price.

Key Features

- High quality die cast, machine finished construction
- Carbon disc drag system
- Sealed carbon disc drag system on All Water models
- Modern large arbor design
- Supplied with reel pouch

Code 21B0031

Model	Lines	Capacity (line/yds/lbs)	Dia.	Wt.(oz)	Reel	Spool
3/4	#3/4	WF4/50/20	3.3"	5.9	£104.99	£52.99
5/6	#5/6	WF6/50/20	3.8"	6.3	£116.99	£62.99
7/8	#7/8	WF8/80/20	4.2"	7.2	£126.99	£62.99
7/8 All Water	#7/8	WF8/80/20	4.2"	7.2	£137.99	£74.99
9/10 All Water	#9/10	WF10/100/30	4.5"	8.2	£149.99	£74.99



High quality bar stock aluminium, machine finished construction

Sealed carbon disc drag system



Greys Tital Reels

Greys flagship fly reel is fully constructed in machined bar stock aluminium and fitted with either a freshwater (3/4 & 5/6) or saltwater (7/8 & 9/10) sealed disc drag system. The reels feature a stunning large arbor design, simple secure spool release system and are machine finished to an outstanding standard.

Key Features

- High quality bar stock aluminium, machine finished construction
- Sealed carbon disc drag system
- Modern large arbor design
- Supplied with reel pouch

Code 21B0030

Model	Lines	Capacity (line/yds/lbs)	Dia.	Wt.(oz)	Reel	Spool
3/4	#3/4	WF4/50/20	3.3"	6.2	£209.00	£104.00
5/6	#5/6	WF6/50/20	3.8"	6.8	£234.00	£116.00
7/8	#7/8	WF8/150/20	4.2"	7.7	£249.00	£116.00
9/10	#9/10	WF10/100/30	4.4"	8.6	£264.00	£126.00

Modern large arbor design



Greys Wing Rods
SEE PAGE 18





Supplied with a custom reel bag & 4 cassette spools



“Offers solid performance and great value for money.”

Large V spool capacity

Airflo Switch Black Reels

The Airflo Switch Black is a die-cast cassette fly reel that offers solid performance and great value for money. Designed for those looking to carry multiple fly lines, each reel comes with 4 additional clear spare spools all supplied in a custom-fitted zipped reel bag.

Key Features

- Large V spool capacity
- Die cast construction
- Strong, reliable drag system
- Complete with 4 additional cassette spools
- Custom reel bag
- Spools retrofit other Airflo cassette reels

Colour: Black

Code 22A0021

Model	Lines	Capacity (line/yds/lbs)	Dia.	Wt.(oz)	Reel	Spool
4/6	#4/5/6	WF6/100/20	3.3"	6.2	£99.99	£9.99
7/9	#7/8/9	WF8/150/20	3.7"	7.3	£99.99	£9.99

Strong, reliable drag system

Large arbor and ultra-lightweight



Tough durable paint finish



Machined aluminium

Snowbee Spectre Reels

The Snowbee Spectre reels are ultra-lightweight, large arbor, precision CNC machined aluminium reels at an amazing price! The stainless steel and cork multi-disc drag offers superb performance. The extra hard paint finish for saltwater and chip resistance, quick release spool and easy left- to right-hand conversion make the Spectre reel the perfect choice. Also available as a cassette spool version with a packaged 4-pack kit containing a reel and 3 spare cassette spools.

Key Features

- Large arbor and ultra-lightweight
- Machined aluminium
- Multi disc, disc drag – cork and stainless steel
- Tough durable paint finish
- Easy spool change and LHW/RHW conversion

Colour: Gunmetal Silver

Code 20A0050

Model	Lines	Capacity (line/yds/lbs)	Dia.	Wt.(oz)	Reel	Spool
3/4	3/4	WF4/50/20	2.9"	3.8	£174.99	£84.99
5/6	5/6	WF6/75/20	3.4"	4.8	£184.99	£94.99
7/8	7/8	WF8/100/20	3.7"	5.1	£194.99	£97.99
5/6 4-Pack	5/6	WF6/75/20	3.4"	5.3	£229.00	£9.99
7/8 4-Pack	7/8	WF8/100/20	3.7"	5.6	£239.00	£9.99



Airflo Superflo 40+ Extreme Fly Line
SEE PAGE 61

Strong, smooth disc drag



Lightweight composite frame and spool

Corrosion proof



Snowbee Classic² Reels

The Snowbee Classic² is a top-quality disc drag reel at a low price. The Classic² reel is precision moulded from fibreglass reinforced nylon producing a lightweight rigid frame which is totally corrosion proof. The large arbor design provides fast retrieve and the composite disc drag gives progressive smooth stopping power. The "V" shaped spool helps to increase the backing capacity. Now also available as a 3-pack version containing a reel and two spare spools supplied in a useful padded storage case.

Key Features

- Large Arbor
- Lightweight composite frame and spool
- Corrosion proof
- Strong, smooth disc drag
- V- Shaped spool increases backing capacity

Colour: Gunmetal

Code 20A0049

Model	Lines	Capacity (line/yds/lbs)	Dia.	Wt.(oz)	Reel	Spool
3/4	3/4	WF4/50/20	2.9"	4.6	£39.99	£15.99
5/6	5/6	WF6/75/20	3.4"	5.1	£42.99	£16.99
7/8	7/8	WF8/100/20	3.8"	5.6	£47.99	£18.99
9/11	9/11	WF10/200/20	4.3"	8.0	£52.99	£19.99
5/6 3-Pack	5/6	WF6/75/20	3.4"	5.1	£84.99	£16.99
7/8 3-Pack	7/8	WF8/100/20	3.8"	5.6	£94.99	£18.99



Spring-loaded, clicker drag-system

Redington ZERO Reels

The Redington ZERO reel is the lightest reel in its class and sets new standards for lightweight performance and affordability. The die-cast construction and the durable spring-loaded clicker drag create the ultimate in lightweight trout reels.

Key Features

- Super-lightweight large arbor design
- Spring-loaded, clicker drag system
- Soft-touch ergonomic handles
- Easily converts to left- or right-hand retrieve

Colours: **A** Black **B** Sand

Code 15B0019

Model	Lines	Capacity (line/yds/lbs)	Dia.	Wt.(oz)	Reel	Spool
2/3	#2/3	WF3/100/20	3.0"	2.7	£119.99	£59.99
4/5	#4/5	WF5/100/20	3.3"	3.0	£119.99	£59.99



Redington RISE III Reels

Redington's RISE reels continue their quest to think beyond traditional reel designs. The RISE features a u-shaped large-arbor with a compact carbon fibre drag system that offers silky smooth fish stopping power. Lightweight design shows through in the modern aesthetic of the Rise, and thoughtful details like twin moulded soft-touch handles and oversized drag knob help the reel perform in the hands of any angler.

Key Features

- CNC machined, anodised 6061-T6 aluminium design with quick release spool
- Ultra-large arbor design for quick line retrieve
- Smooth, compact carbon fibre drag system
- Twin moulded, soft-touch ergonomic handles • Oversized drag knob for easy adjustment • Easily converts to left- or right-hand retrieve • Nylon reel case included

Colours: **E** Silver **F** Black **G** Amber

Code 16B0008

Model	Lines	Capacity (line/yds/lbs)	Dia.	Wt.(oz)	Reel	Spool
3/4	#3/4	WF3/75/20	3.2"	4.0	£239.00	£119.00
5/6	#5/6	WF5/100/20	3.6"	4.6	£239.00	£119.00
7/8	#7/8	WF7/100/20	4.0"	5.5	£269.00	£129.00
9/10	#9/10	WF9/250/20	4.4"	6.3	£269.00	£129.00



Redington BEHEMOTH Reels

The BEHEMOTH reel combines the most powerful drag in its class with stunning looks. The unique die-cast construction is coupled with an interlocking large-arbor spool design. A super-heavy-duty carbon fibre drag brings the utmost in strength, reliability and performance. Available in sizes from trout to salmon and up to saltwater. The BEHEMOTH reels offer performance and affordability to the beginner and veteran anglers alike.

Colours: **C** Gunmetal **D** Black

Code 15B0018

Model	Lines	Capacity (line/yds/lbs)	Dia.	Wt.(oz)	Reel	Spool
5/6	#5/6	WF6/125/20	3.6"	5.7	£139.99	£69.99
7/8	#7/8	WF8/200/20	4.0"	7.5	£139.99	£69.99
9/10	#9/10	WF10/200/30	4.4"	10.8	£159.99	£79.99
11/12	#11/12	WF12/250/30	4.7"	11.4	£159.99	£79.99

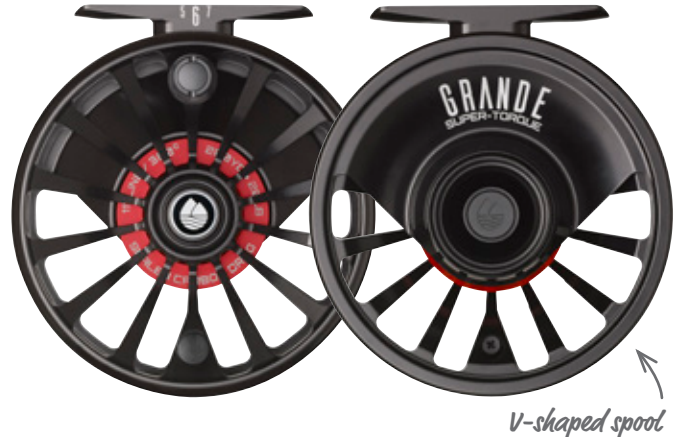

V-shaped spool

Redington GRANDE Reels

The GRANDE reel is a fully machined, anodised, aluminium reel that features Redington's sealed, super-torque, carbon drag system. Redington bulked up the GRANDE with an oversized palming rim, increased backing capacity, and designed an easy to locate handle and drag knob so you can make quick adjustments while fighting big fish.

Key Features

- Fully sealed, super-torque, smooth and powerful carbon drag system
- V-shaped spool
- Oversized palming rim
- Optimised reel foot position
- Enlarged soft-touch Delrin, anti-sag, ergonomic handle

Colour: Black

Code 18B0022

Model	Lines	Capacity (line/yds/lbs)	Dia.	Wt.(oz)	Reel	Spool
5/6/7	#5/6/7	WF6/200/20	3.7"	6.7	£349.00	£169.00
7/8/9	#7/8/9	WF8/200/30	4.1"	7.9	£349.00	£169.00
9/10/11	#9/10/11	WF10/275/30	4.5"	11.0	£399.00	£199.00
11/12/13	#11/12/13	WF12/350/30	4.8"	12.8	£399.00	£199.00



Vision XLV Stillmaniac Cassette Reels

A fantastic new cassette reel from the team at Vision designed to suit the needs of the modern stillwater fly fisher, although its size makes it a perfect fit for predator fishing and sea trout and salmon applications too. A quick-change system allows easy spool release after twisting the locking ring for half a turn. The reel is supplied in a protective neoprene case with 3 additional cassette spoils – the perfect amount to get you set up. If you need more spoils for a larger collection of fly lines, they are available in excellent value twin packs.

Key Features

- Large arbor
- Quick change cassette system
- Vision heraldic V-frame design
- Strong, smooth disc brake
- Built-in counterbalance
- SKF bearing grease

Code 21B0023

Quick change cassette system



Model	Lines	Capacity (line/yds/lbs)	Dia.	Wt.(oz)	Reel	Spool
6/7 Cassette	#6-7	WF7/100/20	4.1"	6.2	£299.00	£29.99 pair
7/8 Cassette	#7-8	WF8/130/20	4.3"	6.3	£299.00	£29.99 pair

Lightweight, die-cast aluminium large arbor design



Quick spool release with captive mechanism

Vision Deep Reels

The Vision Deep is a lightweight aluminium large arbor fly reel with a host of features such as a partly sealed and super smooth disc drag and a re-shaped deeper arbor giving extra capacity for your lines and backing. The non-reflecting matt finish adds durability and looks to the reel.

Key Features

- Lightweight, die-cast aluminium large arbor design
- Strong, smooth and reliable disc drag
- Deep arbor for extra capacity
- Quick spool release with captive mechanism

Colour: Matt Black

Code 13A0062

Model	Lines	Capacity (line/yds/lbs)	Dia.	Wt.(oz)	Reel	Spool
VDP56B	#5-6	WF6/100/20	3.4"	5.8	£79.99	£39.99
VDP78B	#7-8	WF8/150/20	3.7"	6.3	£89.99	£44.99
VDP910B	#9-10	WF9/200/30	4.2"	9.5	£119.99	£59.99

“A quick-change system allows easy spool release after twisting the locking ring for half a turn.”

Carbon & stainless steel disc drags



Vision Hero Reels

A stealthy, modern looking, semi-machined fly reel at a great price. Complete with a powerful yet silky smooth disc drag. The four sizes in the range cover everything from small stream light line fishing through to big river salmon fishing.

- The smallest “Nymph & Dry” size is ideal for modern low-diameter light line techniques thanks to the Hero’s full body rim
- The two “Standard” Hero reels will cover everything from classic river trout fishing, through to stillwater, reservoir, and sea trout fishing
- The largest “Salmon” Hero reel, with its beefed-up waterproof drag system, is perfectly suited to a double-handed salmon rod and has the capacity to hold shooting head lines and plenty of backing

Key Features

- Carbon & stainless steel disc drag
- CNC machined die-cast frame & spool
- Large Arbor
- Full body rims on Nymph and Salmon sizes

Colour: Black

Code 21A0011

Model	Lines	Capacity (line/yds/lbs)	Dia.	Wt.(oz)	Reel	Spool
Nymph & Dry	#3-5	WF4/40/20	3.7"	5.1	£129.99	£49.99
Standard	#4-6	WF6/50/20	3.7"	5.1	£129.99	£49.99
Standard	#7-9	WF8/130/20	4.1"	5.6	£149.99	£49.99
Salmon	#9-10	#9/10/200/30	4.5"	6.0	£169.99	£59.99

Shakespeare®

SINCE 1897

FROM
£84.99

Large arbor spool design

Strong die-cast aluminium construction

SCNC machined handle knob

Shakespeare Oracle 2 Reels

A range of high quality die-cast aluminium fly reels at a fantastic price point, designed to complement the Oracle 2 fly rod range. Features include a large arbor spool design and smooth rulon disc drag with easy left to right-hand retrieve conversion to suit each angler's preference. Sizes in the range suit all freshwater fishing scenarios from small stream fishing through to stillwater and salmon fishing.

Key Features

- Strong die-cast aluminium construction
- CNC machined handle knob
- Large arbor spool design
- Push button spool release
- Convertible left/right hand retrieve
- Strong and smooth drag system

Colour: Black

Code 21B0020



Model	Lines	Capacity (line/yds/lbs)	Dia.	Wt.(oz)	Reel	Spool
3/4	#3-4	WF4/50/20	3.1"	4.9	£84.99	£29.99
5/6	#5/6	WF6/50/20	3.5"	5.8	£94.99	£29.99
7/8	#7/8	WF7/50/20	3.8"	7.1	£99.99	£34.99
8/9	#8/9	WF9/75/20	4.1"	8.8	£102.99	£39.99
10/11	#10/11	WF11/100/30	4.4	10.6	£129.99	£39.99



Shakespeare Oracle 2 Fly Rods
SEE PAGE 21



Wychwood

A tough, durable die-cast frame holds a quickly changeable spool



Wychwood FLOW Reels

A reel offering exceptional value for money. A tough, durable die-cast frame holds a quickly changeable spool. Spools are available in different colours to aid line identification.

Colours: **A** Titanium **B** Platinum

Code 12A0137

Model	Lines	Capacity (line/yds/lbs)	Dia.	Wt.(oz)	Reel	Spool
5/6	#5-6	WF6/100/20	3.6"	5.6	£64.99	£19.99
7/8	#7-8	WF8/100/20	3.9"	5.9	£64.99	£19.99

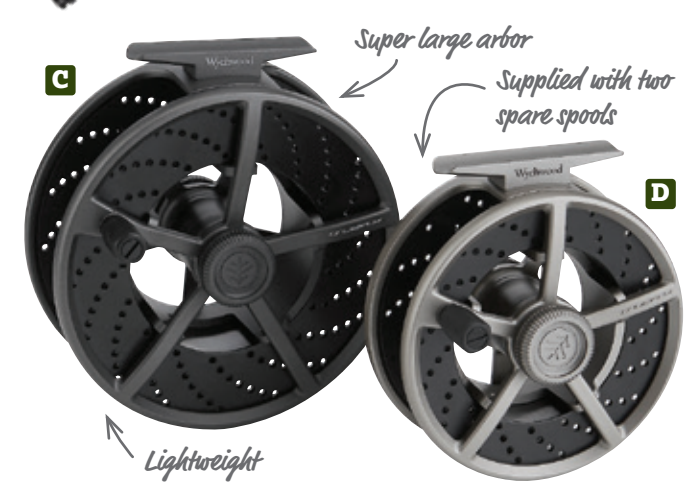

Wychwood Truefly SLA MKII Reels

Wychwood's Truefly Super Large Arbor (SLA) MKII cassette reel has been created using the highest design specification and a contemporary design to produce the largest arbor and the lightest reel in its class. The modern lightweight design is attained by using die-cast aluminium with as much material removed as possible without compromising on strength or functionality. The Truefly SLA MKII is built around a super-strong, smooth and concealed Rulon drag system. It is supplied in a custom built protective zipped case, complete with two spare lightweight polycarbonate spools.

Key Features

- Super large arbor
- Lightweight
- Super-strong Rulon drag
- Supplied with two spare spools
- Protective case

Colours: **C** Champagne **D** Silver

Code 17A0008

Model	Lines	Capacity (line/yds/lbs)	Dia.	Wt.(oz)	Reel	Spool
5/6	#5-6	WF6/75/20	3.7"	5.8	£99.99	£14.99
7/8	#7-8	WF8/100/20	4.2"	6.5	£109.99	£14.99



Designed for lightness, strength, smoothness and speed



Nautilus X-Series Reels

The Nautilus X-Series is an open-frame reel designed for lightness, strength, drag smoothness and fast line pick up. The totally sealed SCF-X drag is a Teflon® and carbon fibre disc drag system. It is adjusted with a generous drag knob that offers superior gripping surface and texture for wet and cold fingers.

Colours: **A** Black **B** Titanium

Code **16A0102**

Model	Lines	Capacity (line/yds/lbs)	Dia.	Wt.(oz)	Reel	Spool
XS	#3-4	WF4/100/20	3.2"	3.8	£456.00	£220.00
XM	#4-5	WF5/105/20	3.5"	4.1	£480.00	£234.00
XL	#6-7	WF7/150/20	4.0"	4.7	£564.00	£266.00
XL MAX	#8-9	WF9/150/20	4.0"	4.7	£600.00	£306.00

Sealed SCF-X drag is a Teflon® and carbon fibre disc drag system



RIO Perception Elite Fly Line
SEE PAGE 55



InfinAdjust oversized drag knob

Ceramic bearings



Dual action sealed drag

Nautilus CCF-X2 Reels

The Nautilus CCF-X2 features a lightweight design and an upgraded dual action CCF-X2 drag capable of generating more than 20lbs of drag. All the CCF-X2 models are fully sealed and are loaded with hybrid ceramic bearings, TPX bushing and have an oversized drag with InfinAdjust range settings.

Key Features

- Dual action sealed drag
- Ceramic bearings
- TPX bushings
- InfinAdjust oversized drag knob

Colour: Silver

Code **15A0045**

Model	Lines	Capacity (line/yds/lbs)	Dia.	Wt.(oz)	Reel	Spool
6/8	#6-8	WF8/175/20	4.0"	7.6	£696.00	£353.00
8/10	#8-10	WF10/200/30	4.5"	8.6	£828.00	£393.00
10/12	#10-12	WF12/250/30	4.5"	8.9	£856.00	£426.00
Silver King	#10-12	WF12/250/30	5.0"	9.1	£1056.00	£513.00

My first reel from this brand. Wanted it as a dual-purpose thing for heavier double handed work in UK with fairly light drag settings and saltwater use overseas with heavy drag settings and good line pickup. Feels solid and top-quality finish in line with price and the brands reputation. A lot of turns to adjust drag settings but drag knob is a good size and easy to grip.

MIKES July 2021

CUSTOMER REVIEWS



Quick release spool



Ultra-lightweight

Ross Evolution R Reels

The Evolution R is not only lightweight but also incredibly strong and durable. The ultra-large arbor spool is uniquely engineered to ensure even line retrieval. The fully sealed, carbon fluoropolymer and stainless steel drag design features an impressive 16-discs in the R Salt and 7-discs in standard Evolution Rs. The drag knob with its solid grip is perfectly integrated into the reel and the comfortable, grippy canvas phenolic handle is also an industry first.

Key Features

- Ultra-lightweight •Sealed drag •Canvas phenolic custom handle
- Type II anodised •Quick release spool •Easy left to right conversion

Colour: Black

Code 18A0057

Model	Lines	Capacity (line/yds/lbs)	Dia.	Wt.(oz)	Reel	Spool
4/5	#4/5	WF4/95/20	3.5"	4.4	£575.00	£431.00
5/6	#5/6	WF5/110/20	3.8"	4.4	£575.00	£431.00
7/8 Salt	#7/8	WF8/215/20	4.1"	7.5	£695.00	£521.00
9/10 Salt	#9/10	WF10/275/20	4.4"	8.0	£795.00	£596.00
11/12 Salt	#11/12	WF12/250/30	4.7"	8.8	£895.00	£671.00

Machined from lightweight 6061 aluminium



Ross Evolution LTX Reels

The Evolution LTX is a modern, super-lightweight, large-arbor reel with a strong, smooth, sealed and stacked-disc drag system. The canvas phenolic ergonomic handle ensures a comfortable grip even when wet. The LTX includes an innovative machined leader groove to keep your leader securely wrapped around the outside of the frame, kink free.

Key Features

- Machined from lightweight 6061 aluminium •Ultra-smooth, stacked-disc drag system
- Hard anodised for increased durability •Hand built in USA

Colours: **A** Silver **B** Black

Code 18A0137

Model	Lines	Capacity (line/yds/lbs)	Dia.	Wt.(oz)	Reel	Spool
LTX 3/4	#3/4	WF4/50/20	3.4"	4.2	£475.00	£356.00
LTX 4/5	#4/5	WF5/70/20	3.5"	4.3	£475.00	£356.00
LTX 5/6	#5/6	WF6/95/20	3.8"	4.6	£475.00	£356.00
LTX 7/8	#7/8	WF8/150/20	4.0"	4.9	£475.00	£356.00

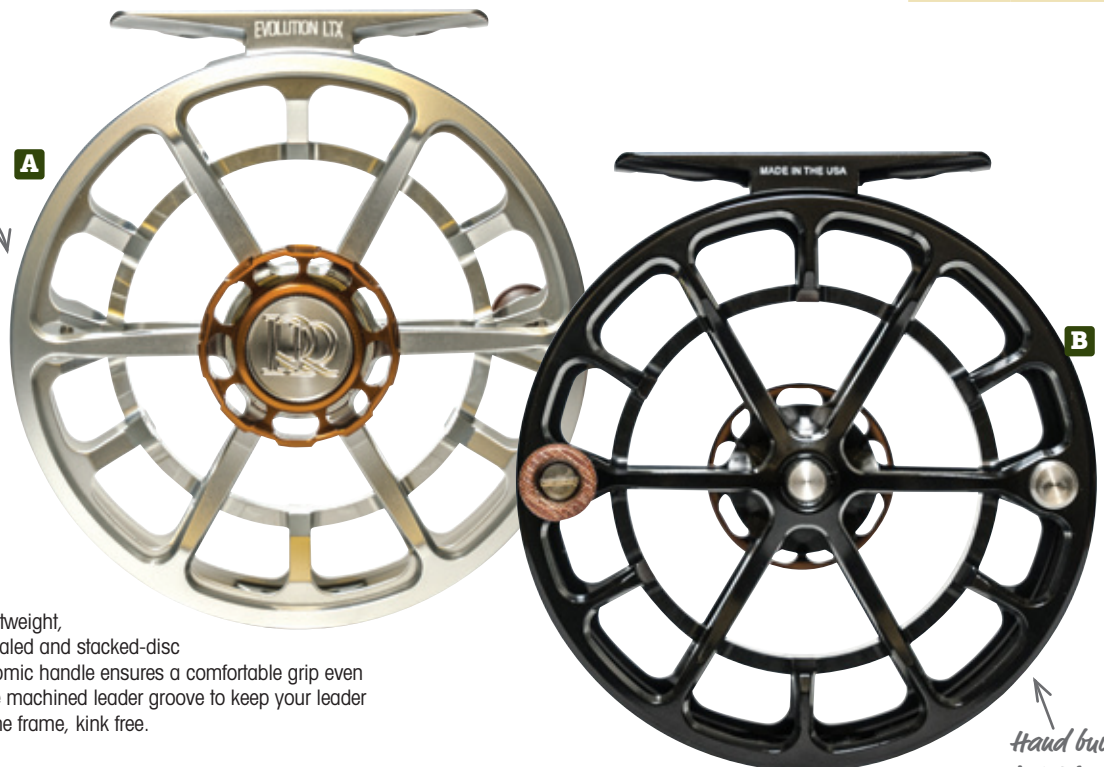

Hand built in USA

I've owned quite a lot of different trout reels but this is the best I've tried. Really light yet solid, looks great. Useful features include the handle and spool groove for the arbor knot. I bought the 5/6 size and it helped to land some solid Avington rainbows on its first outing. Everything a modern fly reel should be and really nothing to dislike about it.

ALAN May 2020

CUSTOMER REVIEWS



Abel SDS Reels

The award-winning Abel SDS (Sealed Drag Salt) is a powerhouse of a reel, capable of taking on saltwater gamefish of all sizes. A unique, completely sealed, multi-disc drag system yields an incredible 20+ pounds of braking power. Available in three sizes, this makes the SDS perfect for fighting big bonefish on light tippet as well as providing the power needed to subdue hard-fighting tarpon, GTs and billfish.

Key Features

- Made from 6061-T651 aerospace grade aluminium
- Sealed, multi-disc drag system
- Quick change spool
- User convertible RH wind to LH wind
- Made in USA



Code 22A0022

Model	Lines	Capacity (line/yds/lbs)	Dia.	Wt.(oz)	Reel	Spool
SDS 7/8	#7/8	WF8/240/20	3.9"	8.9	£995.00	£746.00
SDS 9/10	#9/10	WF10/250/20	4.2"	9.8	£1095.00	£821.00
SDS 11/12	#11/12	WF12/250/30	4.5"	10.0	£1195.00	£896.00

User convertible RH wind to LH wind



Abel SDF Reels

The SDF (Sealed Drag Fresh) is a scaled-down version of the award-winning SDS reel featuring a similar completely sealed, multi-disc drag system suited to freshwater applications. The SDF boasts a strong, smooth drag with an adjustment range from zero to an amazing 10 pounds with virtually zero start-up inertia.

Key Features

- User convertible RH wind to LH wind
- Drag ranges from zero to 10lbs
- Quick change spool
- Made in USA



Code 22A0023

Model	Lines	Capacity (line/yds/lbs)	Dia.	Wt.(oz)	Reel	Spool
SDF 4/5	#4/5	WF5/75/20	3.3"	5.0	£795.00	£596.00
SDF 5/6	#5/6	WF6/100/20	3.6"	5.4	£845.00	£634.00
SDF 6/7	#6/7	WF7/145/20	3.7"	5.6	£895.00	£671.00

Abel TR Click & Pawl Reels

The Abel TR is an, award-winning, improved-remake of a classic lightweight large-arbor reel with a striking modern design, feel and sound. Machined from 6061 lightweight aluminium and consisting of only 21 meticulously machined parts ensures a lifetime of dependable use. The TR reel features an integrated precision-balanced clicker on the spool retaining the iconic click-pawl sound. The pronounced palming rim is deliberately shaped to help manually control drag pressure.

Key Features

- A click-pawl drag protects light tippet while preventing overruns
- Partially-ported frame for the perfect balance of weight, sound, and aesthetics
- Engraved silhouettes of a stonefly, caddis and mayfly inside the frame
- Quick-change spool with a threaded release cap
- Designed and hand-machined by trout junkies in Colorado, USA

Colour: Black

Code 18B0023



Designed and hand-machined by trout junkies in Colorado, USA

Partially-ported frame for the perfect balance of weight, sound, and aesthetics

Model	Lines	Capacity (line/yds/lbs)	Dia.	Wt.(oz)	Reel	Spool
TR2/3	#2/3	WF3/50/20	3.1"	4.2	£475.00	£356.00
TR4/5	#4/5	WF5/65/20	3.3"	4.6	£475.00	£356.00

Abel reels can be specially ordered in a range of different colours and can also be custom finished with your special message or design.

Please visit www.sportfish.co.uk

or call 01544 327 111 for more information.

REEL ACCESSORIES



Fishpond Ripple Reel Cases

The padded sides and moulded top and bottom offer great protection and the padded internal dividers help keep all your reels, spools, tools and other kit safe and organised.

Available in 2 sizes:

A Medium – Blue (4-Reels) 25 x 12 x 11cm **£39.99**

B Large – Brown (6-Reels) 30 x 20 x 14cm **£69.99**

Code 20A0130

Fishpond Stowaway Reel Case

The impact-resistant moulded bottom and cushioned interior will hold up to 10 reels and the removable padded dividers allow for a variety of organisational configurations for reels, fly boxes and your other important possessions.

Colour: Granite **Size:** 37 x 15 x 28cm

Code 20A0131 £119.99



Wychwood Competition Reel Case

This innovative reel case features a unique T-fold design allowing storage for up to 18 reels or spare spools. The quick click access system allows you to open and reseal the bag with the minimum of fuss. Mesh pockets for additional storage and a rubberised tab for attaching essentials.

Colour: Olive Green **Size:** 26 x 35 x 13cm

Code 19A0043 £59.99

Spool Tenders

A superbly designed product. Wrap around your spare spool. Velcro® closure with pull tab. Pack of 2.

Size: 12" x 3/4" **Code 11584 £5.99**



Wychwood Reel Bag

This reel bag is capable of safely storing up to 6 reels or spools. Features include adjustable internal dividers, 3 mesh pockets to hold leaders, tippets or accessories and an oversized top for extra protection.

Colour: Olive Green **Size:** 13 x 35 x 13cm

Code 19A0044 £39.99



Guideline Reel and Gear Bag

Keep all your reels and accessories safe in this padded case with its adjustable inner dividers. Made from a tough and weather resistant TPU fabric with a moulded, waterproof bottom and a rigid frame. There are 4 large, zipped mesh pockets on the inside of the lid and an extra zipped and padded laptop pocket.

Colour: Grey **Size:** 45 x 35 x 20cm

Code 14A0537 £109.99



Hard-wearing case made from rip-stop polyester fabric

Flexible storage of up to 10 large salmon reels

Snowbee Reel Brief

Protect and store your valuable reels in this hard-wearing case made from rip-stop polyester fabric with a stiff, padded, lid and sides and a convenient two way zip. Eight (8) internal, adjustable, dividers allow flexible storage of up to 10 large salmon reels.

Colour: 2-Tone Sage Green **Size:** 37 x 27 x 16cm

Code 18B0039 £37.99

Sage Reel Cases

The perfect protection for your valuable reels. High density neoprene stretches to fit various reel sizes and the stretch flap allows for the case to be used on or off a rod.

Colour: Black with slate grey Sage logo

Available in 5 sizes:

Small (0wt-4wt), Medium (4wt-6wt), Large (6wt-8wt), XLarge (8wt-10wt), XXLarge (10wt-Spey)

Code 90510 £19.99



Removable padded shoulder strap and a reinforced grab handle

Simms GTS Reel Vault

Protect up to 12 of your favourite reels with padded adjustable internal dividers and a compression-moulded exterior built from super-tough 1680D ballistic fabric with a water-shedding DWR finish. Interior mesh pockets and sleeves keep your leaders & lines organised. Features include a rugged lockable double zip, removable padded shoulder strap and a reinforced grab handle.

Colour: Carbon **Size:** 38.1 x 22.8 x 17.7cm

Code 20B0051 £99.99



Transparent lid

Wychwood EVA Large Reel Case

The Wychwood EVA Large Reel Case is a fantastic storage solution for those fishers who like to carry plenty of extra reels and spools. Designed with movable dividers which allow you to customise the size of each zone to keep your reels safely secured.

Colour: Grey **Size:** 49cm (w) x 23cm (d) x 11cm (h)

Code 21B0041 £44.99

Wychwood Compact Reel Case

Complementing the range of Wychwood EVA luggage (p177) is the compact reel case, built with a rigid form to help protect your reels and spools from damage. A clear lid allows you to see the contents of the bag and movable internal dividers allow for customisation.

Colour: Grey **Size:** 24cm (w) x 24cm (d) x 11cm (h)

Code 21B0042 £34.99



Neoprene Stretch Cases

Stretches to fit a range of reel sizes.

Available in 2 sizes:

C Trout **£6.99**

D Salmon/Large Arbor **£6.99**

Code 11581





SIMON GAWESWORTH

Education and Engagement
Manager for Far Bank
(RIO, Sage, Redington)

FLY LINES FOR SINGLE-HANDED RODS

Choosing the correct fly line to balance your fly rod and to best serve the intended purpose of the line is critical to fly fishing success. Your rod and line must work together to make casting and fishing a pleasure and the wrong choice of line can make even the best fly rod cumbersome and uncooperative.

Fly lines have two components: the inner core and the outer coating.

The core

Every fly line has a core that runs through the centre of the line. The core provides the strength of the line and is a major factor in how stiff (or supple) the line is. The core also controls how much stretch there is in a line, with low stretch cores providing greater feel and control in casting and fishing techniques, and more stretchy cores providing greater shock absorption with super light tippets.

Fly lines that are designed for tropical conditions are made with a stiffer core, as high temperatures will result in a standard fly line becoming very limp and soft, and not shooting well. If used in cool/normal UK conditions these lines are usually stiff and wiry and need to be stretched before they can be used.

The coating

The core of a line is surrounded by a plastic coating (usually PVC) that is bonded to the core. The coating influences the line's shape, weight and density.

Shape

Line manufacturers vary the shape of a fly line to make it perform in different ways. These 'shape' changes determine the line's casting behaviour. For example, a line with a long front taper and a light front end lands softly on the water and is great for presentation but would be useless with a heavy fly or in a tough wind. A line with a lot of weight at the front end, and a short front taper, would be far better suited for such challenging conditions, but would have poor presentation.

Weight

Fly lines are generally made to an industry standard weight called the AFTM standard. It is a number given to both line and rod (usually between 1 and 12) that ensures matching numbered fly lines and fly rods balance and load perfectly. For example, put a 6wt line on a 6wt rod and a 2wt line on a 2wt rod, and so on. The standard is based on the weight of the first 30 feet of line.

Density

The density of the coating determines whether the line floats or sinks. Floating lines have tiny 'microspheres' to make them float, while sinking lines have tungsten added to the coating to make them sink. Lines can sink at any speed between 1 and 8 inches per second.

A fly line is usually designated by a code on the front of the box, something like 'WF6F'. Usually, the first two letters of this code tell you the shape (profile) of the line, the number tells you the size (weight) of the line, and the last letter tells you if it floats or sinks. In this example 'WF' means it is a 'weight forward' line, '6' means it is for a 6wt rod, and 'F' means that it floats. If it had an 'S' at the end, it would mean that the line would sink, and a number after the S tells you how fast it sinks. For example, a 'WF7S6' is a weight forward, 7wt sinking line that sinks at 6 inches per second.

Anatomy of a typical Weight Forward fly line

Tip - This section attaches to the leader and may feature a loop for this purpose. It is short, usually 6-12".

Front taper - This section, typically 4'-12', increases in diameter as you move away from the tip. The longer and gentler the taper, the more delicately the fly will land.

Body - This thicker section is where most of the casting weight is and is the part that loads a fly rod for a cast.

Rear taper - Here the line reduces in diameter and can vary in length from 1' to as much as 12' - depending on what the line is designed to do.

Head - The 'head' of a fly line incorporates the tip, front taper, the body and the rear taper and it is usually the weight of this head that gives the line its size.

Running line - This last, level section is thin in diameter and light in weight, which means there is little drag when making the final cast, and helps anglers make long casts.





RIO Perception Elite

- An all-round, shorter headed fly line with super slick, ultra-low stretch performance
- Built with RIO's exceptionally slick, durable SlickCast coating
- ConnectCore Plus ultra-low stretch core helps cast timing, hook setting and mending
- SureFire tri-colour system improves accuracy and distance control.
- Factory fitted front and rear welded loops

Code 20B0003

ConnectCore Plus ultra-low stretch core helps cast timing, hook setting and mending



Length	Head	Colour	AFTM	Price
30yds	35-38ft	Green/Camo/Grey	WF3-8	£129.99



RIO Gold Elite

- The ultimate highest performing all-round fly line with super slick, ultra-low stretch performance
- Built with RIO's exceptionally slick, durable SlickCast coating
- ConnectCore Plus ultra-low stretch core helps cast timing, hook setting and mending
- SureFire tri-colour system improves accuracy and distance control.
- Factory fitted front and rear welded loops

Code 20B0001

Built with RIO's exceptionally slick, durable SlickCast coating



Length	Head	Colour	AFTM	Price
30yds	46-50ft	Moss/Gold/Grey	WF4-8	£129.99



RIO Grand Elite

- Designed for fast actioned rods with its super slick, ultra-low stretch performance
- Built with RIO's exceptionally slick, durable SlickCast coating
- ConnectCore Plus ultra-low stretch core helps cast timing, hook setting and mending
- SureFire tri-colour system improves accuracy and distance control
- Factory fitted front and rear welded loops

Code 20B0002

SureFire tri-colour system improves accuracy and distance control



Length	Head	Colour	AFTM	Price
30yds	37-41ft	Green/Yellow/Grey	WF4-8	£129.99



RIO Technical Trout Elite

- Designed for delicate presentation of small flies with an extended thin front taper
- Built with RIO's exceptionally slick, durable SlickCast coating
- ConnectCore Plus ultra-low stretch core helps cast timing, hook setting and mending
- SureFire tri-colour system improves accuracy and distance control.
- Factory fitted front and rear welded loops

Code 20B0004

Factory fitted front and rear welded loops



Length	Head	Colour	AFTM	Price
30yds	45-54ft	Blue/Peach/Grey	WF3-6	£129.99



RIO Elite Stillwater Floating

- All-round stillwater line designed to turn over long leaders & indicators
- Quick loading line gives great feedback when casting either long or short
- Low-stretch ConnectCore Plus for the best in performance and smoothness
- SlickCast – the slickest and most durable coating available

Code 22B0004

Length	Head	Colour	AFTM	Price
Upto 33yds	49-51ft	Oge/Gm/Yell	WF5-8	£99.99



RIO Single Handed Spey Elite

- Smoothest casting weight forward line designed by RIO
- Designed for easy roll and overhead casts
- ConnectCore for maximum sensitivity and performance
- SlickCast - the slickest and most durable coating available
- Twin-colour with welded loops at each end

Code 21B0035

Length	Head	Colour	AFTM	Price
30yds	Floating	Peach/Como	WF4-8	£129.99
30yds	Intermediate	Grey/Glac/Como	WF4-8	£129.99



RIO InTouch VersiTip II

- Powerful front taper for big flies and easy distance
- 4 x 15ft tips. Floating, Intermediate, Sink 3 & Sink 6
- ConnectCore for maximum sensitivity, control and performance
- Welded loops on all tips for easy rigging

Code 15B0045

Length	Head	Colour	AFTM	Price
Upto 33yds	35ft	Straw/Light Green	WF5-10	£189.99



Lee Wulff Triangle Taper

- Triangle taper casts like a shooting head for distance
- Efficient energy transfer allows for delicate presentation
- J3 coating enhances durability, shootability and flotation

Code 11206

Length	Head	Colour	AFTM	Price
30yds	Medium	Ivory	TT2-8	£79.99
30yds	Medium	Olive	TT2-8	£79.99



Lee Wulff Triangle Taper - Two Tone

- Triangle taper casts like a shooting head for distance
- Efficient energy transfer allows for delicate presentation
- J3 coating enhances durability, shootability and flotation

Code 11206

Length	Head	Colour	AFTM	Price
30yds	Medium	Two Tone Yel/Wht	TT4-8	£79.99



Scientific Anglers Amplitude MPX

- AST Plus slickness for superior shooting and increased durability
- Combined floating texture on tip & shooting texture on running line
- Improved version of the Mastery GPX taper
- Best for large dry flies, nymphs and streamers
- Braided multifilament core

Code 17A0040

Length	Head	Colour	AFTM	Price
30yds	Medium	Green/Grass/Buckskin	WF4-8	£129.99



Scientific Anglers Mastery MPX Twin Colour

- Improved version of the Mastery GPX
- Half-size heavy to load modern rods and turn over large flies
- Excellent with dry flies, nymphs and lures
- Features ST+ slickness added to the coating
- Printed line ID and welded loops at both ends

Code 16A0044

Length	Head	Colour	AFTM	Price
30yds	Medium	Green/Buckskin	WF4-8	£79.99



Scientific Anglers Mastery ART All-Round Taper

- Half size heavy to load rods quickly
- Powerful taper helps turn over long leaders
- Great for roll and single-handed Spey casting
- Two-tone stealthy colours with a camouflage tip
- Floating texture on tip for higher flotation
- Braided multifilament core with welded loops

Code 17A0092

Length	Head	Colour	AFTM	Price
33yds	Medium	Bamboo/Olive/Camo	WF3-8	£79.99



Scientific Anglers Frequency Trout

- All-round trout line
- Versatile taper excels with most flies and conditions
- Mid-length head
- Braided multifilament core
- Formulated with advanced shooting technology

Code 15A0088

Length	Head	Colour	AFTM	Price
29yds	13yds	Buckskin	WF3-8	£64.99



Airflo Superflo Ridge 2.0 Universal Taper

- Features Airflo's new Ridge 2.0 technology
- Universal taper - perfect all-round line for both short and long range
- Made from ultra-durable polyurethane rather than PVC
- Laser identification on each line
- Neat welded loops front and back

Code 23A0057

Length	Head	Colour	AFTM	Price
30yds	Medium	Red/Grey	WF5-8	£99.99



Airflo Superflo Stillwater

- Ultimate taper for distance and presenting a team of flies
- Airflo's "FLO" technology results in thinner running line
- Made from ultra-durable polyurethane. PVC free.
- Laser identification on each line
- Neat welded loops front and back

Code 21A0096

Length	Head	Colour	AFTM	Price
30yds	Long	Lichen/Ivory	WF5-8	£69.99



Mackenzie NX Trout

- Specially formulated extra supple coating helps create tighter loops for perfect turnover
- Precise tapers achieve consistent casts
- Extended rear taper provides stability
- Dual colour helps find the perfect loading point
- Welded loops factory fitted to front and rear

Code 21A0068

Length	Head	Colour	AFTM	Price
30yds	43ft	Ivory/Moss	WF3-7	£49.99



RIO Creek Premier

- Designed for anglers fishing small streams
- Loads at close range, ideal for short to medium casts
- Supple coldwater core results in tangle-free performance
- MaxFloat tip ensures the line tip does not sink
- Ideal for nymphs, dries and small flies
- SlickCast - the slickest and most durable coating available
- Twin-colour with welded loops at each end

Code 21A0116

Length	Head	Colour	AFTM	Price
75ft	Short	Green/Yellow	WF1-4	£99.99



RIO Perception Premier

- An all-round, shorter headed fly line with super slick performance
- Built with RIO's exceptionally slick, durable SlickCast coating
- Features MaxFloat tip and printed ID on each line
- DualTone colour system making it easy to find the perfect loading point
- Factory fitted front and rear welded loops

Code 20B0007

Length	Head	Colour	AFTM	Price
30yds	35-38ft	Green/Camo	WF3-8	£99.99



RIO Gold Premier

- RIO's unique taper design for optimum distance, control and presentation
- Built with RIO's exceptionally slick, durable SlickCast coating
- DualTone colour system making it easy to find the perfect loading point
- Factory fitted front and rear welded loops
- Features MaxFloat tip and printed ID on each line

Code 20B0005

Length	Head	Colour	AFTM	Price
30yds	45-50ft	Moss/Gold	WF3-8	£99.99



RIO Mainstream Trout

- Short powerful front taper for good presentation and turnover
- Heavier, easy casting line for modern fly rods
- Great general purpose line for all trout situations
- Made in the USA to RIO's usual high standards

Code 13A0063

Length	Head	Colour	AFTM	Price
26.7yds	Short	Green	WF3-8	£39.99



RIO Technical Trout Premier

- Designed for delicate presentation of small flies with an extended thin front taper
- Built with RIO's exceptionally slick, durable SlickCast coating
- DualTone colour system making it easy to find the perfect loading point.
- Factory fitted front and rear welded loops
- Features MaxFloat tip and printed ID on each line

Code 20B0008

Length	Head	Colour	AFTM	Price
Up to 30yds	45-54ft	Blue/Peach	WF3-6	£99.99
Up to 30yds	80-90ft	Blue/Peach	DT3-6	£99.99



RIO Grand Premier

- One size heavy and designed for fast actioned rods with its super slick performance
- Built with RIO's exceptionally slick, durable SlickCast coating
- DualTone colour system making it easy to find the perfect loading point.
- Factory fitted front and rear welded loops
- Features MaxFloat tip and printed ID on each line

Code 20B0006

Length	Head	Colour	AFTM	Price
30yds	36-41ft	Green/Yellow	WF3-8	£99.99



“Powerful front taper for big flies and easy distance.”

Twin colour with welded loops on both ends

RIO Premier OutBound Short

- Powerful short head & front taper for big flies and easy distance
- SlickCast - the slickest and most durable coating available
- Multi Density Control for complete depth control and contact with the fly
- Twin-colour with welded loops on both ends
- Available as floating, 15ft sink tip, full intermediate or sinking

Code 21B0036

Length	Head	Density	Colour	AFTM	Price
33.3yds	30ft	Floating	Moss/Ivory	WF5-10	£99.99
33.3yds	30ft	15ft Inter.Tip	Clear/Moss/Ivory	WF6-10	£99.99
33.3yds	30ft	Intermediate	Clear/Trans Green	WF6-10	£99.99
33.3yds	30ft	Sink 1/3/5ips	Black/Trans Green	WF6-10	£99.99



SlickCast - the slickest and most durable coating available



Cortland 444 Classic Peach

- Excellent general purpose line
- The precision taper softly turns over leaders for delicate presentation
- Supple fly line with superior buoyancy and glass-smooth surface

Code 11189

Length	Head	Colour	AFTM	Price
30yds	Medium	Peach	WF3-9	£60.99
30yds	Medium	Peach	DT4-7	£60.99



Cortland 444 Classic Olive

- Excellent general purpose line
- The precision taper softly turns over leaders for delicate presentation
- Supple fly line with superior buoyancy and glass-smooth surface

Code 11189

Length	Head	Colour	AFTM	Price
30yds	Medium	Olive	WF4-5	£60.99



Cortland 444 Sylk

- Traditional silk line designs with long front tapers
- Designed for the avid bamboo and glass rod angler
- Very soft and thinner than other lines

Code 60159

Length	Head	Colour	AFTM	Price
30yds	Medium	Mustard	WF3-6	£60.99
30yds	Medium	Mustard	DT3-5	£60.99



Snowbee XS

- Nano Coating Technology (NCT) gives great shootability and delicate presentation
- Smooth, supple and long-lasting line
- A balanced profile with a long shallow taper and long belly
- Available in ivory, hi-viz orange or twin-colour
- Memory free with welded loops at both ends

Code 22A0027

Length	Head	Colour	AFTM	Price
30yds	40ft	Ivory	WF4-8	£54.99
30yds	40ft	Orange	WF5-8	£54.99
30yds	40ft	Ivory / Blue	WF4-8	£64.99



Snowbee XS-Plus Spectre Distance

- A distance line with a long head and extended rear taper for greater distance
- Nano Coating Technology (NCT) gives great shootability and improved presentation
- Twin-coloured to help find the ideal loading point.
- Memory free with welded loops at both ends

Code 22A0028

Length	Head	Colour	AFTM	Price
40yds	47ft	Ivory/Chartreuse	WF5-8	£64.99



Cortland 444SL

- For anglers looking for distance casts
- Provides a greater degree of stiffness
- Reduces friction caused by line sag
- Increases efficiency and distance of your cast

Code 11186

Length	Head	Colour	AFTM	Price
35yds	Long	Mint Green	WF6-8	£60.99

Wychwood



Wychwood Feather Floater

- Wychwood's fly line for stealth, delicacy and finesse
- Casts like a dream with its long slender body
- Pin-point accuracy and presentation thanks to the fine front taper
- High floating with a super-buoyant coating
- Welded loop at front end

Code 16A0066

Length	Head	Colour	AFTM	Price
30yds	Medium	Green	WF3-7	£39.99

Wychwood



Wychwood Rocket Floater

- Great line for distance casts on stillwaters, lakes & reservoirs
- Works well with big flies or teams of flies
- Bullet shaped taper casts well on windy days
- High floating with a super buoyant coating
- Welded loop at front end

Code 16A0067

Length	Head	Colour	AFTM	Price
30yds	Medium	White	WF5-7	£39.99



Snowbee XS-Plus Thistledown

- Thinnest, most supple WF profile possible
- Nano Coating Technology (NCT) with a braided core
- Micro-welded loops at both front and back
- Three sizes available including a brook line

Code 22A0029

Length	Head	Colour	AFTM	Price
30yds	27ft	Olive/Buckskin	WF1-4	£64.99
30yds	34ft	Olive/Buckskin	WF2-5	£64.99
30yds	34ft	Olive/Buckskin	WF5-7	£64.99



RIO Premier Aqualux (1.5 - 2.0ips)

- Short, easy-casting head for maximum distance
- Clear intermediate line perfect for fishing in the top 2-6 feet
- Ultra-slick, coloured running line for the very best in distance
- SlickCast – the slickest and most durable coating available

Code 22B0005

Length	Head	Colour	AFTM	Price
Upto 33yds	30ft	Clear/Tr Green	WF4-8	£89.99



RIO Elite Hover (1.0ips)

- Short, easy-casting head for maximum distance
- Ultra-low stretch ConnectCore Plus for the ultimate in sensitivity and hook sets
- SlickCast – the slickest and most durable coating available
- Hang markers at 20ft to show where to fish “The Hang”

Code 22B0006

Length	Head	Colour	AFTM	Price
Upto 33yds	30ft	Grey/Olive	WF5-8	£99.99



RIO Elite Camolux (1.5 - 2.0ips)

- Short, easy-casting head for maximum distance
- Ultra-low stretch ConnectCore Plus for the ultimate in sensitivity and hook sets
- SlickCast – the slickest and most durable coating available
- Hang markers at 20ft to show where to fish “The Hang”

Code 22B0007

Length	Head	Colour	AFTM	Price
Upto 33yds	30ft	Camo/Dk Green	WF4-8	£99.99



Scientific Anglers Frequency

- Uniform sink rates, from tip to belly
- Especially effective for fishing streamers
- Thin diameter cuts through wind
- Mid-length head for enhanced line control
- Sink rate 1 ¼ – 2 inches per second

Code 15A0089

Length	Head	Colour	AFTM	Price
27yds	13yds	Atmosphere Blue	WF5-8	£64.99



Scientific Anglers Sonar Stillwater Clear Camo

- Clear camo line for stealthy presentation
- Excellent on windy days
- Monofilament core
- Small diameter for easy casting
- Sink rate 1 ¼-2 inches per second
- Printed line ID and welded loops at both ends

Code 18A0151

Length	Head	Colour	AFTM	Price
30yds	Medium	Clear	WF5-8	£109.99



Snowbee XS-Plus “Hover” Slow Intermediate

- Nano Coating Technology (NCT) gives great shootability and delicate presentation with the same profile as the popular Snowbee XS floating lines
- Super slow uniform sink rate of 1-1 ½ ips
- Designed to “hang” just below the surface
- Memory free with welded loops at both ends

Code 22A0030

Length	Head	Colour	AFTM	Price
30yds	42.5ft	Mustard/Ivory	WF5-8	£64.99



Wychwood Ghost Clear Intermediate

- Great line for distance casts on stillwaters, lakes & reservoirs
- Clear line for stealthy presentation
- Bullet shaped taper casts well on windy days
- Sink rate 1 ½ inches per second
- Welded loop at front end

Code 16A0068

Length	Head	Colour	AFTM	Price
30yds	Medium	Clear	WF6-8	£39.99



Cortland 444 Classic Clear Camo

- Super stealthy, blends into any sub surface environment
- Slowest full sinking line on the market
- Ideal for shallow water conditions and spooky fish
- Will remain supple in the coldest of conditions
- Sink rate 1 ½-2 inches per second

Code 11190

Length	Head	Colour	AFTM	Price
30yds	Medium	Clear Camo	WF5-8	£60.99



Cortland 444 Classic Ice Blue

- Super stealthy, blends into any sub surface environment
- Slowest full sinking line on the market
- Ideal for shallow water conditions and spooky fish
- Will remain supple in the coldest of conditions
- Sink rate 1 ½-2 inches per second

Code 11190

Length	Head	Colour	AFTM	Price
30yds	Medium	Ice Blue	WF6-8	£60.99

RIO PRODUCTS



RIO Premier Midge Tip - 3ft Tip

•Two 3ft tip options available - clear 1.5ips or hover 1.0ips •Ideal for fishing nymphs and buzzers in the top layers •SlickCast – the slickest and most durable coating available •Factory built loops at both ends

Code 22B0002

Length	Head	Colour	AFTM	Price
Upto 33yds	40-42ft	Hover 1.0ips	WF5-8	£89.99
Upto 33yds	40-42ft	Clear 1.5ips	WF5-8	£89.99

RIO PRODUCTS



RIO Premier Midge Tip Long - 6ft Tip

•Two 6ft tip options available - clear 1.5ips or hover 1.0ips •Ideal for fishing nymphs and buzzers in the top layers •SlickCast – the slickest and most durable coating available •Factory built loops at both ends

Code 22B0003

Length	Head	Colour	AFTM	Price
Upto 33yds	40-42ft	Hover 1.0ips	WF5-8	£89.99
Upto 33yds	40-42ft	Clear 1.5ips	WF5-8	£89.99

Snowbee



Snowbee XS-Plus Buzzer Tips (4ft, 10ft)

•Perfect lines for fishing buzzers and nymphs below the surface •Nano Coating Technology (NCT) gives great shootability and delicate presentation •Available with either a 4ft or 10ft slow sinking (1¾ips) tip •Memory free with welded loops at both ends

Code 22A0041

Length	Tip	Colour	AFTM	Price
30yds	4ft	Olive/Ivory	WF5-8	£64.99
30yds	10ft	Blue/Ivory	WF5-8	£64.99

Cortland



Cortland Precision Ghost Tip

•5ft or 15ft clear Ghost Tip •Ideal for use with nymphs and buzzers in stillwaters •An excellent fly line developed for those line-shy trout

Code 11188

Length	Head	Sink Rate	Colour	Tip Length	AFTM	Price
35yds	Medium	1.5-2.0 IPS	Mint Green/Clear	5ft	WF5-7	£84.99
35yds	Medium	1.5-2.0 IPS	Mint Green/Clear	15ft	WF6-8	£84.99

Cortland



Cortland 444 Classic

•10' sink-tip offers the best combination of floating and sinking line •Keeps your fly down to where the fish are feeding •Can be mended and picked up almost like a full floating line •A firm favourite with salmon and sea trout fishermen

Code 11195

Length	Head	Sink Rate	Colour	Tip Length	AFTM	Price
30yds	Medium	3.5-4.0 IPS	Peach/Brown	10ft	WF6-8	£60.99

Lee Wulff



Lee Wulff Predator Triangle Taper

•Features a 10ft clear intermediate (1.5IPS) tip built onto a floating line •Easy, long casting triangle taper profile gives excellent turnover and delicate presentation •Monocore line for supple handling

Code 90169

Length	Head	Sink Rate	Colour	Tip Length	AFTM	Price
30yds	Medium	1.5 IPS	Clear/White	10ft	TT5-8	£99.99

airflo



Laser ID printed for easy identification

Welded loop at each end

Airflo Superflo Sink Tips

When sub-surface and washing line techniques demand the ultimate in line control the Airflo Superflo Sink Tips offer the most comprehensive range to cover all techniques. Each line is laser ID printed for easy identification and has a welded loop at each end.

Code 22A0031

Model	Length	Head	Sink Rate	Colour	AFTM	Price
3ft Fast Tip	35yds	51ft	1.5ips	Olive/Green	WF6-8	£69.99
6ft Slow Tip	35yds	51ft	0.5ips	Grey/Green	WF6-8	£69.99
12ft Slow Tip	35yds	51ft	0.5ips	Grey/Green	WF6-8	£69.99
12ft Mid Tip	35yds	51ft	1.0ips	Orange/Brown	WF6-8	£69.99



Super slick coating for an even longer casting fly line

Each line has a laser printed ID for easy identification

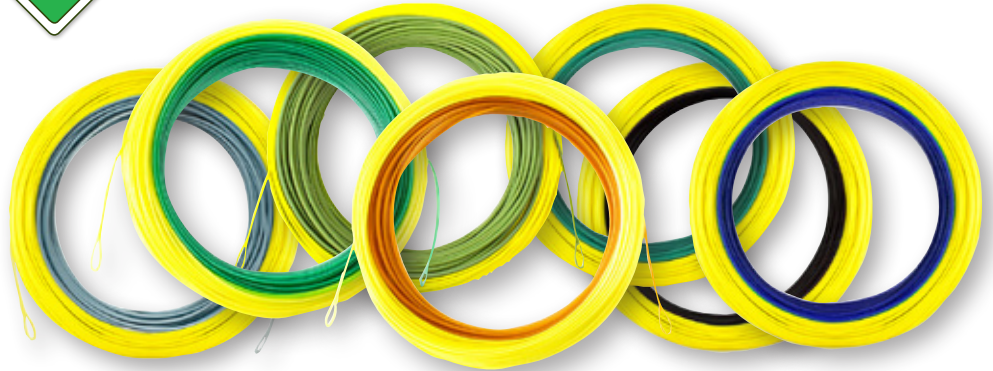

Airflo Superflo 40+ Extreme

An updated version of Airflo's popular 40+ fly line series, incorporating Superflo ultra-thin running line and super slick coating for an even longer casting fly line. These lines are also built around Airflo's power core so you'll have no trouble feeling takes and setting hooks, even when fishing at distance. For ease of use, each line has a laser printed ID for easy identification and a welded loop at each end for simple leader and backing attachment. This line range is ideal for the stillwater or reservoir angler looking to maximise their distance and explore all the depths in their fishery with models in the range covering everything from full floating to a Di7.

Model	Length	Head	Sink Rate	Colour	AFTM	Price
Floating	41yds	35ft	Float	Grey/Yellow	WF6-8	£69.99
Slow Int	41yds	35ft	0.5ips	Olive/Yellow	WF6-8	£69.99
Mid Int	41yds	35ft	1.0ips	Tan/Yellow	WF7-8	£69.99
Fast Int	41yds	35ft	1.5ips	Green/Yellow	WF6-8	£69.99
Di3	41yds	35ft	3.0ips	Dk Green/Yellow	WF6-8	£69.99
Di5	41yds	35ft	5.0ips	Blue/Yellow	WF6-8	£69.99
Di7	41yds	35ft	7.0ips	Black/Yellow	WF6-8	£69.99

Code 22A0042



Ideal line to use from a boat or from the bank

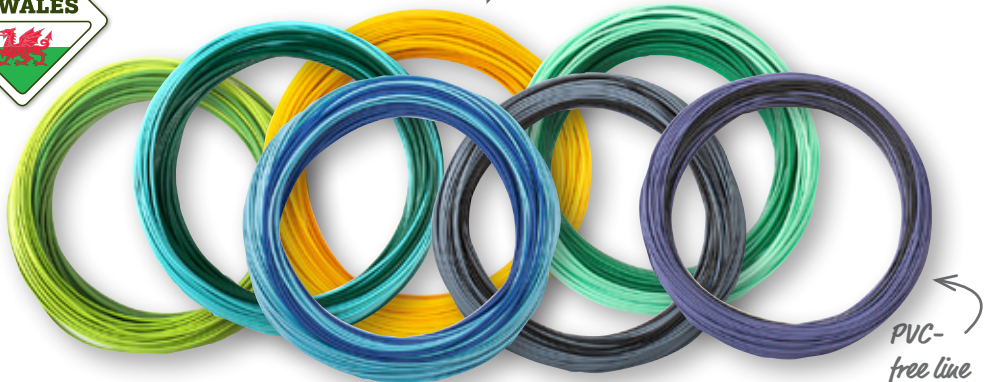

PVC-free line

Airflo Sixth Sense

Ideal from a boat or from the bank this is an updated and improved version of a best-seller with added high visibility "hang markers" at 10ft and 20ft on the intermediate and sinking lines. These PVC-free fly lines are also twin-coloured with a marked "haul zone" to help you identify the optimum loading point for more efficient casts. All lines are 105ft/35yds long.

•Unique low stretch "Power Core" gives incredible sensitivity and improves feel and hooking, even at extreme range •"Delta Taper" with its long front taper helps improve casting distance, accuracy and control

Model	Length	Head	Sink Rate	Colour	AFTM	Price
Slow Int	35yds	46ft	0.5ips	Trans Olive/Pale Green	6/7, 7/8	£59.99
Mid Int	35yds	46ft	1.0ips	Trans Tan/Pale Tan	6/7, 7/8	£59.99
Fast Int	35yds	46ft	1.5ips	Trans Green/Mid Green	6/7, 7/8	£59.99
Di3	35yds	46ft	3.0ips	Dark Green/Aqua	6/7, 7/8	£59.99
Di5	35yds	46ft	5.0ips	Dark Blue/Pale Blue	6/7, 7/8	£59.99
Di7	35yds	46ft	7.0ips	Black/Grey	6/7, 7/8	£59.99
Di8	35yds	46ft	8.0ips	Black/Purple	6/7, 7/8	£59.99

Code 20A0117



Airflo 40+ Booby Basher

The ideal line for serious boat or bank anglers looking for unrivalled distance. This super-fast sinking line has a sink rate of 8ips. The long 55ft head needs to be cut back to suit individual rods and casting styles.

Code 21B0029



This super-fast sinking line has a sink rate of 8ips

Length	Head	Sink Rate	Colour	AFTM	Price
55yds	Cut to Size	8ips	Orange/Black	Cut to Size	£69.99



RIO Premier Fathom

The most advanced range of sinking lines - perfect for the stillwater or reservoir angler.

- Built with RIO's exceptionally slick, durable SlickCast coating
- Short, quick-loading head for easy-casting and quick distance
- Built on a supple, tangle free core
- Hang markers at 20ft shows where to fish "The Hang"
- Coloured running lines show the perfect loading spot for each cast
- Welded loops and ID on each line for easy identification and quick changes



Coloured running lines show the perfect loading spot for each cast

Code 22A0032

Model	Length	Head	Sink Rate	Colour	AFTM	Price
Sink 3	35yds	35ft	3ips	Black/Blue	WF5-8	£99.99
Sink 5	35yds	35ft	5ips	Black/Maroon	WF5-8	£99.99
Sink 6	35yds	35ft	6ips	Black/Green	WF5-8	£99.99
Sink 7	35yds	35ft	7ips	Black/Grey	WF6-8	£99.99



Scientific Anglers Sonar Seamless Density

Seamless Density technology provides a smooth transition between densities, eliminates hinging and provides a straight line connection to the fly.

- Designed for modern fast actioned rods
- Based on the popular Scientific Anglers GPX/MPX tapers
- Convenient 20ft and 10ft textured hang markers
- Welded loops at both front and rear

Designed for modern fast actioned rods



Welded loops at both front and rear

Code 18A0061

Model	Length	Head	Sink Rate	Colour	AFTM	Price
Sink1/Sink3	35yds	35ft	1-3ips	Lt Green/Dk Green	WF4-7	£109.99
Sink3/Sink5	35yds	35ft	3-5ips	Dk Green /Charcoal	WF5-7	£109.99
Sink5/Sink7	35yds	35ft	5-7ips	Charcoal/Black	WF7-8	£109.99



Cortland 444 Classic

- Cortland's most popular range of sinking lines
- Medium head lengths for easier casting
- Up to 7 inches per second sink rate
- Available in two sink rates to ensure all depths are covered

Medium head lengths for easier casting



Code 11192

Model	Length	Head	Sink Rate	Colour	AFTM	Price
Type 3	30yds	Medium	3.5-4.0 IPS	Brown	WF7-8	£60.99
Type 6	30yds	Medium	6.0-7.0 IPS	Black	WF7-8	£60.99



RIO Premier Fathom Clean Sweep

A unique sinking line available in two different sink rates, designed for the stillwater or reservoir angler.

- Built with RIO's exceptionally slick, durable SlickCast coating
- The body sinks faster than the tip or running line resulting in a deadly "U" shaped retrieve
- Clear 7ft intermediate front section
- Short, quick-loading head for easy-casting and quick distance
- Hang markers at 20ft shows where to fish "The Hang"
- Welded loops and ID on each line for easy identification and quick changes



Welded loops and ID on each line for easy identification and quick changes

Code 22A0033

Model	Length	Head	Sink Rate	Colour	AFTM	Price
S2/S4/Int	35yds	35ft	2/4/1.5ips	Clear/Black/Aqua	WF5-8	£99.99
S4/S6/Int	35yds	35ft	4/6/1.5ips	Clear/Black/Aqua	WF6-8	£99.99



Scientific Anglers Wet Cel Sinking

Back by popular demand. A superb range of value for money sinking lines from the award winning Wet Cel name. Available in four different sink rates to suit every possible condition and variety of species.

Available in four different sink rates



Code 16A0037

Value for money sinking lines from the award winning Wet Cel name

Model	Length	Head	Sink Rate	Colour	AFTM	Price
Wet Cel I	80ft	40ft	1 ¼ IPS	Clear	WF5-8	£45.99
Wet Cel II	80ft	40ft	1 ¾ - 2 ¾ IPS	Brown	WF5-8	£45.99
Wet Cel IV	80ft	40ft	4-5 IPS	Charcoal	WF5-8	£45.99
Wet Cel VI	80ft	40ft	4 ½ - 6 IPS	Black	WF5-8	£45.99



Scientific Anglers Frequency Sink

- Uniform sink rates, from tip to belly
- Especially effective for fishing streamers
- Thin diameter cuts through wind
- Mid-length head for enhanced line control

Mid-length head for enhanced line control



Code 15A0307

Model	Length	Head	Sink Rate	Colour	AFTM	Price
III	30yds	13yds	2.5-4.0 IPS	Dk Green	WF5-8	£64.99
VI	30yds	13yds	5.0-6.0 IPS	Dk Grey	WF5-8	£64.99



RIO DirectCore Bonefish Elite

- Low stretch & low memory DirectCore lays straight on the water and results in hard positive hook sets
- Built with SlickCast, the world's slickest and most durable coating
- Long head & rear taper for maximum casting
- Hard tropical coating that will not wilt in the heat

Code 21A0006

Length	Head	Colour	AFTM	Price
33yds	49.5ft	Sand/Orange/Blue	WF7-9	£129.99



Lee Wulff Bermuda 2-Tone

- Lee Wulff's best selling all-round tropical fly line
- Super hard, textured, slick coating
- 16-strand braided monofilament core
- Dual coloured line

Code 60155 (2-Tone floating)

Code 80105 (Lost Tip 12ft Intermediate)

Model	Length	Head	Colour	AFTM	Price
Floater	33.5yds	Medium	Blue/Sand	WF7-13	£99.99
Int Tip	35yds	Medium	Clear/Blue	WF8-12	£129.99



RIO Premier Coastal QuickShooter XP

- Ideal for UK conditions and general coastal fishing
- Short, powerful front taper to turnover large flies
- Supple core and coating that will not tangle in cooler conditions
- Clear, intermediate, easy loading 33ft head

Code 23A0044

Length	Head	Colour	AFTM	Price
33yds	33ft	Clear/Purple	WF8-10	£99.99



RIO Premier Bonefish QuickShooter

- The best, easy-casting line for bonefish and other flats species for the wading or boat angler
- The short head loads the rod quickly and delivers fast accurate casts
- Built with RIO's exceptionally slick, durable SlickCast coating for maximum distance
- Includes a RIO factory fitted loop on each end for easy rigging

Code 22A0035

Length	Head	Colour	AFTM	Price
30yds	Short 34.5ft	Aqua Blue/Sand	WF7-9	£99.99



RIO Premier Tarpon QuickShooter

- An easy casting line designed for tarpon and other tropical species
- Short powerful head & front taper handles large flies effortlessly
- Built with RIO's exceptionally slick, durable SlickCast coating for maximum distance
- RIO factory fitted loop on each end for easy rigging

Code 22A0036

Length	Head	Colour	AFTM	Price
33.3yds	Short 30ft	Camo/Ivory	WF10-12	£99.99



RIO Elite Tropical OutBound Short

- Short, heavy head & powerful front taper casts the biggest of flies with ease
- Low-stretch DirectCore for hard, solid strip sets
- Built with RIO's exceptionally slick, durable SlickCast coating
- Available as a full floating line or an intermediate line with a 15ft clear head

Code 22A0037

Model	Length	Head	Colour	AFTM	Price
Floater	33.3yds	Short 30ft	Dark Sand/Blue	WF8-12	£129.99
Intler	33.3yds	Short 30ft	Clear/Grey/Blue	WF8-12	£129.99



RIO Flats Pro Elite

- Low stretch & low memory DirectCore lays straight on the water and results in hard positive hook sets
- Built with SlickCast, the world's slickest and most durable coating
- Mid head length & long rear taper for perfect control
- Extreme Slickness with front and back loops and ID marking
- 2 Options: Floating or Stealth Tip (6ft foot clear intermediate tip)

Code 21A0003

Option	Length	Head	Colour	AFTM	Price
Floating	33yds	Medium	Aqua/Orange/Sand	WF7-12	£129.99
Stealth Tip	33yds	Medium	Clear/Aqua/Orange/Sand	WF8-12	£129.99



RIO Elite GT

- Specifically designed for the demands of the GT angler
- Short, heavy head & powerful front taper casts the biggest of flies
- Low-stretch, ultra-strong DirectCore in excess of 60lbs for solid strip sets
- Built with RIO's exceptionally slick, durable SlickCast coating
- SureFire tricolored measuring system for increased accuracy & distance control

Code 21B0096

Length	Head	Colour	AFTM	Price
33.3yds	Short 36ft	Blue/Orange/Sea Grass	WF10-12	£129.99



RIO Elite Leviathan Fast Sinking

- Fast sinking line designed specifically for large tropical species
- Short, heavy head & powerful front taper casts the biggest of flies
- Low-stretch, ultra-strong DirectCore in excess of 60lbs for solid strip sets
- Built with RIO's exceptionally slick, durable SlickCast coating
- Density Compensation for complete depth control

Code 22A0038

Grains	AFTM	Length	Head	Sink Rate	Price
300gr	#8/9	33.3yds	Short 26ft	6.7ips	£129.99
350gr	#9/10	33.3yds	Short 26ft	7.2ips	£129.99
400gr	#10/11	33.3yds	Short 26ft	7.7ips	£129.99
500gr	#12/13	33.3yds	Short 26ft	8.5ips	£129.99



RIO PRODUCTS

BEST SELLER

Scandinavian Series
Scandi VersiTip
#7FT

Can be used with single-handed rods

Supplied with 4 (Float, Intermediate, Sink 3 & Sink 5) looped and interchangeable 10ft tips

RIO Scandi Short VersiTip Kit - 4 x VersiTips - No Shooting Line

A complete ready-to-go outfit (just add running line) designed specifically for switch and short Spey rods. Supplied with 4 (Float, Intermediate, Sink 3 & Sink 5) looped and interchangeable 10ft tips. Can also be used with single-handed rods – come down 3 sizes.

Code 12A0228

Size	Head Weight	Head Length	Colour	Price
#5	320 grains/21g	33ft	Straw	£159.99
#6	370 grains/24g	33ft	Straw	£159.99
#7	425 grains/28g	38ft	Straw	£159.99
#8	485 grains/31g	38ft	Straw	£159.99
#9	550 grains/36g	38ft	Straw	£159.99



RIO PRODUCTS

Short head and a powerful front taper for easy casts

ELITE
The Legend

Switch Chucker

SCANDINAVIAN SERIES
#7 / 465gr
Gray/Orange/Green
SlickCast

RIO Switch Chucker Elite

A short headed (25ft) easy-loading line designed for switch rods, whether for overhead or spey casting with a low-stretch core and an ultra-slick durable coating.

- Short head and a powerful front taper for easy casts
- Low-stretch ConnectCore Plus for the best in performance and smoothness
- Built with RIO's exceptionally slick, durable SlickCast coating
- Orange coloured section indicates the most efficient rod loading length
- RIO factory fitted loops at each end

Code 21B0072

Length	Head	Colour	AFTM	Price
33.3yds	25ft	Grey/Orange/Green	WF6 (420 grains)	£129.99
33.3yds	25ft	Grey/Orange/Green	WF7 (465 grains)	£129.99
33.3yds	25ft	Grey/Orange/Green	WF8 (520 grains)	£129.99
33.3yds	25ft	Grey/Orange/Green	WF9 (570 grains)	£129.99



Snowbee

Thin orange running line for the ultimate in distance and presentation

New 'Nano' Coating Technology

Snowbee XS Salmon Spey Line
Colour

300' 10.12m

Snowbee XS Switch Line
SF400 - #7/8
Head 30ft Line 120ft

Snowbee XS-Plus Prestige Switch

A very easy to cast, modern, full floating switch line. The line features a compressed short head which is smoothly connected to the thin orange running line for the ultimate in distance and presentation. These lines cast best when used in conjunction with a Versileader or Polyleader.

Code 22A0039

Size	Length	Head	Colour	Price
350gr/#6/7	40yds	29ft	Ivory/Orange	£69.99
400gr/#7/8	40yds	30ft	Ivory/Orange	£69.99
450gr/#8/9	40yds	30ft	Ivory/Orange	£69.99



mackenzie
DESIGNED THROUGH EXPERIENCE

Dual head design helps create the perfect D-loop and smooth energy transfer resulting in perfect turnover

NX Switch Line

mackenzie
DESIGNED THROUGH EXPERIENCE

NX Switch Line

G4

NX SWITCH LINE
FLOATING WF#8

Mackenzie NX Switch

- Ideal switch line for all casting abilities
- Dual head design helps create the perfect D-loop and smooth energy transfer resulting in perfect turnover
- Extended rear taper provides stability
- Dual colour helps find the perfect loading point
- Factory fitted front and rear welded loops

Code 21A0069

Length	Head	Colour	AFTM	Price
40yds	36ft	Moss/White	#7/8 (394 grains) 25.5g	£64.99



RIO PRODUCTS

Long front taper that unrolls with great efficiency and power

RIO PRODUCTS

AN EASY CASTING Scandinavian Spey Line designed for effortless, efficient and great presentation

Scandinavian Series
InTouch Scandi OutBound
SPEY

#8

RIO InTouch Scandi Outbound Switch

This smooth casting Scandinavian line with no joints and a shorter head is a switch version of our best-selling Scandi outbound spey line

- Short head that loads quickly and makes it easy to cast in tight spaces
- Rear loaded weight distribution for effortless, efficient spey casts
- Long front taper that unrolls with great efficiency and power

Code 22A0111

Size	Head Weight	Head	Colour	Price
#7	425 grains / 28g	33ft	Green/Orange/Straw	£119.99
#8	485 grains / 31g	33ft	Green/Orange/Straw	£119.99



Built on RIO's ConnectCore for maximum sensitivity, control and performance



With its short head this line is designed to load rods quickly and cast easily

RIO InTouch Scandi Outbound Spey - Floating

This improved version features RIO's ConnectCore for maximum sensitivity, control and performance. Built on exactly the same taper as RIO's award winning Scandi shooting heads but with the convenience of a simple all-in-one weight forward line with no joins. With its short head this line is designed to load rods quickly and cast easily. This line works best when paired with a suitable RIO Spey VersiLeader (see page 69).

Code 16A0033

Size	Head Weight	Head Length	Colour	Price
#7/8	460grains/29.8g	37ft	Green/Orange/Straw	£119.99
#8/9	520grains/33.7g	38ft	Green/Orange/Straw	£119.99
#9/10	580grains/37.6g	39ft	Green/Orange/Straw	£119.99
#10/11	640grains/41.5g	40ft	Green/Orange/Straw	£119.99



Designed for easy casting in areas of restricted space



Snowbee XS-Plus Short Spey

Snowbee XS-Plus Short Spey lines have been designed to meet the needs of the modern salmon and sea trout angler for easy casting and for use in areas of restricted space. A combination of the best of scandi style lines and integrated shooting-head lines these will quickly load your rod and shoot a long way with gentle presentation. For the best turnover it is recommended to cast these lines with the addition of a Polyleader or VersiLeader p85.

Code 22A0040

Size	Head Weight	Head Length	Colour	Price
#7/8	370grains/24g	44ft	L.Blue/D.Blue	£69.99
#8/9	555grains/36g	44ft	L.Blue/D.Blue	£69.99
#9/10	617grains/40g	44ft	L.Blue/D.Blue	£69.99



RIO InTouch Short Head Spey Line (Interchangeable 15ft Tip)

This is an uncomplicated, very easy casting, traditional style floating Spey line with the added advantage of an interchangeable 15ft front tip. The head length varies between 40ft and 50ft depending on the line size. Built on RIO's ConnectCore for maximum sensitivity, control and performance. This is a user friendly line which suits any salmon angler who wants a traditional floating salmon line with the ability to quickly change to a sinking tip if required.

Code 15B0053

Head Weight	Head	Length	Colour	Price
6/7 (470 grains)	42ft	36.7yds	Blue/Orange/Straw	£129.99
7/8 (520 grains)	44ft	36.7yds	Blue/Orange/Straw	£129.99
8/9 (580 grains)	46ft	38.3yds	Blue/Orange/Straw	£129.99
9/10 (650 grains)	48ft	40.0yds	Blue/Orange/Straw	£129.99
10/11 (730 grains)	50ft	40.0yds	Blue/Orange/Straw	£129.99

RIO InTouch Mid Head Spey

RIO's InTouch Mid Head Spey line has an easy casting mid-head, with a series of step tapers that unroll with extreme ease and efficiency. Built with RIO's ultra-low stretch ConnectCore for the very best in performance. Features RIO's Agent X & XS (Extreme Slickness) technologies as well as welded loops on both ends, and a loading point marker. The perfect line for rods between 13ft and 14ft on mid-sized rivers.

Code 16B0029

Head Weight	Head	Length	Colour	Price
7/8 (590 grains)	54ft	36.7yds	Green/Orange/Straw	£129.99
8/9 (650 grains)	56ft	38.3yds	Green/Orange/Straw	£129.99
9/10 (710 grains)	58ft	40.0yds	Green/Orange/Straw	£129.99
10/11 (785 grains)	60ft	40.0yds	Green/Orange/Straw	£129.99

RIO InTouch Long Head Spey

This line is designed for bigger rivers and longer Spey rods. The sophisticated tapers make this one of the easiest traditional style, long belly, Spey lines available. Built on RIO's ConnectCore for maximum sensitivity, control and performance. The useful orange mid-section shows the caster the optimum load point for the line. The welded front loop helps with super-quick leader changes.

Code 15B0054

Head Weight	Head	Length	Colour	Price
8/9 (690 grains)	66ft	38.3yds	Peach/Orange/Straw	£129.99
9/10 (765 grains)	68ft	40.0yds	Peach/Orange/Straw	£129.99
10/11 (840 grains)	70ft	40.0yds	Peach/Orange/Straw	£129.99

RIO PRODUCTS

AN EXTREMELY VERSATILE Scandi style head complete with a selection of interchangeable tips

SCANDINAVIAN SERIES
Scandi VersiTip

SPEY

#10 Scandi VersiTip

Four 15ft long interchangeable RIO VersiTips

All supplied in a convenient mesh wallet

RIO Scandi VersiTip - 4 x VersiTips - No Shooting Line

An extremely versatile Scandinavian type shooting head body with four 15ft long interchangeable RIO VersiTips (Floating, Intermediate, Sink3 and Sink6). This is the big brother of the RIO Scandi Short VersiTip kit and works best with 13ft, 14ft and 15ft salmon rods. All supplied in a convenient mesh wallet.

Code 15A0043

Size	Head Weight	Head Length	Colour	Price
#8	510 grains/33g	38ft	Straw	£169.99
#9	585 grains/38g	38ft	Straw	£169.99
#10	650 grains/42g	39ft	Straw	£169.99
#11	700 grains/45g	40ft	Straw	£169.99

BEST SELLER

Airflo Rage Tri Tip Kit - Three 12ft Tips

A short-headed spey line kit with built-in integrated ridged running line and three interchangeable 12ft tips to cover a multitude of fishing conditions. Welded loops at both ends makes changing the tips rapid and easy. Kit comes complete with three 12ft tips: Floating, Intermediate and Sink 3.

Code 23A0058

Size	Head Weight	Head Length	Price
7/8	34g / 525grains	27ft+12ft = 39ft	£129.99
8/9	38g / 586grains	28ft+12ft = 40ft	£129.99
9/10	42g / 648grains	29ft+12ft = 41ft	£129.99
10/11	44g / 679grains	31ft+12ft = 43ft	£129.99



RIO InTouch Scandi 3D Shooting Heads

Built on RIO's ultra-low stretch ConnectCore these are very easy casting Scandi shooting heads and are available in a series of multi-densities to further improve casting and fishing control. Printed line ID and welded loops at both ends.

Available in 3 different Densities:

Floating/Hover/Intermediate, Hover/Intermediate/Sink3, Intermediate/Sink3/Sink5

Code 16A0069

Size	Head Weight	Length	Flt/Hov/Int	Hov/Int/S3	Int/S3/S5
#7/8	480grains/31g	34ft	£64.99	£64.99	-
#8/9	520grains/34g	38ft	£64.99	£64.99	£64.99
#9/10	580grains/38g	39ft	£64.99	£64.99	£64.99
#10/11	640grains/42g	40ft	£64.99	£64.99	£64.99



RIO AFS Shooting Head Kit

An all-in-one simple kit that covers most fishing situations.

- Floating AFS shooting head
- RIO shooting line
- 3 RIO Versi Leaders. (Intermediate, Sink3, Sink6)

Code 90130

Size	Head Weight	Head Length	Colour	Price
#7/8	460 grains/30g	37.5ft	Green/Yellow	£169.99
#8/9	520 grains/34g	38.5ft	Green/Yellow	£169.99
#9/10	580 grains/38g	39.5ft	Green/Yellow	£169.99
#10/11	640 grains/42g	40.5ft	Green/Yellow	£169.99



RIO InTouch Skagit Max GameChanger Shooting Head

Easy-casting, multiple-density Skagit heads for large flies and heavy sink tips with an ultra-low stretch ConnectCore.

Three different seamless multi-densities available.

- Float/Hover/Intermediate
- Float/Hover/Intermediate/Sink3
- Float/Intermediate/Sink3/Sink5

Code 18B0021

Size	Head Length	Head Weight	Price
#7	23ft	500 Grains	£64.99
#8	23ft	550 Grains	£64.99
#8/9	24ft	600 Grains	£64.99
#9	25ft	650 Grains	£64.99
#10/11	25ft	725 Grains	£64.99



RIO Skagit Max Launch Elite

RIO Skagit Max Launch heads deliver the power required to cast large flies and heavy sinking tips, with a taper design that transfers energy more elegantly than Skagit lines of the past. The lines feature a low stretch core for sensitivity and enhanced take detection when fishing at range and RIO's SlickCast outer coating for reduced friction.

Code 21A0005

Model	Size	Head Weight	Head Length	Price
Skagit Max Launch 450	#6/7	450grains/29g	23ft/7.0m	£64.99
Skagit Max Launch 500	#7	500grains/32g	23ft/7.0m	£64.99
Skagit Max Launch 550	#8	550grains/36g	23ft/7.0m	£64.99
Skagit Max Launch 575	#8	575grains/37g	24ft/7.3m	£64.99
Skagit Max Launch 600	#8/9	600grains/39g	24ft/7.3m	£64.99
Skagit Max Launch 650	#9	650grains/42g	25ft/7.6m	£64.99
Skagit Max Launch 675	#9/10	675grains/44g	25ft/7.6m	£64.99
Skagit Max Launch 700	#10	700grains/45g	25ft/7.6m	£64.99

RIO's SlickCast outer coating for reduced friction



Low-stretch core for sensitivity and enhanced take detection when fishing at range

mackenzie
DESIGNED THROUGH EXPERIENCE

Integrated running line attached

Factory welded loops at both ends



Mackenzie NX Integra Shooting Head

The Mackenzie Integra is a floating shooting head with a built-in, integrated running line attached.

- Unique tapers help presentation and turnover
- Supply yet durable coating creates tighter loops and improves turnover and performance
- Factory welded loops at both ends
- Twin colour to indicate the perfect rod loading length

Code 23A0051

Size	Head Weight	Head Length	Length	Price
#8/9	585 grains/38g	38.5ft	40yds	£79.99
#9/10	648 grains/42g	40.0ft	40yds	£79.99
#10/11	679 grains/44g	44.0ft	40yds	£79.99

mackenzie
DESIGNED THROUGH EXPERIENCE



Durable coating creates tighter loops and improves turn over and performance



Mackenzie NX Spey

A new range of high-performance Mackenzie NX Spey lines developed for the modern double handed salmon angler.

- Unique tapers help presentation and turnover
- Supple yet durable coating creates tighter loops and improves turnover and performance
- Factory welded loops at both ends
- Twin colour to indicate the perfect rod loading length
- Choice or two head lengths 50ft of 55ft on the #10/11

Code 23A0052

Size	Head Weight	Head Length	Length	Price
#8/9	540 grains/35g	50ft	40yds	£79.99
#9/10	663 grains/43g	55ft	40yds	£79.99
#10/11	756 grains/49g	55ft	40yds	£79.99
#10/11	787grains/51g	65ft	40yds	£79.99



Interchangeable 10ft tips to fine tune your presentation and depth



Scientific Anglers Ultimate Scandi Taper (UST) Shooting Heads Multi Tip Kit - 4 Tips

A fantastic multi-tip kit for the floating UST textured shooting head fly line, equipping you with a range of four interchangeable 10ft tips to fine tune your presentation and depth. The kit includes Floating, Intermediate, Sink 2/Sink 4, and Sink 7 tips.

A simple loop-to-loop connection between the head and interchangeable tips provides a smooth and seamless transition to eliminate hinging and provide a straight-line connection to the fly.

Code 21A0064

Gram	Grain	Line Weight	Length Inc. Tip	Price
34g	520 grain	#7/8	9.5m	£154.99
38g	590 grain	#8/9	10.3m	£154.99
41g	630 grain	#9/10	11.2m	£154.99
45g	700 grain	#10/11	12.2m	£154.99



Available in comfortable, manageable lengths and weights



Guideline Power Taper 3D+ Shooting Heads

Based on the award winning, best-selling, original Triple-D lines, this improved range of shooting heads is pre-looped and are "ready-to-go". They are available in comfortable, manageable lengths and weights that suit most rods and anglers and they provide true 3D sinking, casting and fishing performance. All 3D+ lines are pre-fitted with small, strong, coated loops with colour coded sleeves and ID printing.

Available in 7 different Densities:

Floating/Hover/Intermediate, Floating/Hover/Sink2, Hover/Intermediate/Sink3, Intermediate/Sink2/Sink4, Sink1/Sink3/Sink5, Sink2/Sink4/Sink6, Sink3/Sink5/Sink8
Sizes: #8/9=33g, #9/10=37g and #10/11=44g

Code 17A0084

Size	Weight	Length	F/H/1	F/H/S2	H/I/S3	I/S2/S4	S1/S3/S5	S2/S4/S6	S3/S5/S8
#8/9	510grains/33g	36ft	£99.99	£99.99	£99.99	£99.99	-	-	-
#9/10	570grains/37g	38ft	£99.99	£99.99	£99.99	£99.99	£99.99	£99.99	£99.99
#10/11	680grains/44g	40ft	£99.99	£99.99	£99.99	£99.99	£99.99	£99.99	£99.99

RIO PRODUCTS

RIO Elite Metered Shooting Line

RIO's ultimate shooting line packed with features that result in longer casts and greater hook-ups. Built with RIO's SlickCast on an ultra-low stretch ConnectCore with RIO's "RangeFinder" system, a colour change every 10ft to gauge how far each cast is. A short front taper stabilizes the cast and ensures maximum distance. Large loops help fast rigging changes. 30m spools.

4 Sizes: .026"/20lbs/Grey, .032"/20lbs/Green, .037"/30lb/Blue, .042"/30lb/Yellow

Code 21A0004 £64.99



RIO PRODUCTS

RIO Powerflex Ultra Shooting Line

- Hard, tough coated shooting line for durability and long casts
- Powerflex Core that does not wilt or tangle
- Large factory-fitted welded loops at both ends for fast, easy rigging
- 100ft long

5 Sizes: Orange (.025"/25lbs), Green (.030"/25lbs), Blue (.035"/30lbs), Yellow (.040"/35lbs), Aqua (.045"/50lbs)

Code 21B0071 £64.99



RIO PRODUCTS

RIO GripShooter Shooting Line

Based on RIO's SlickShooter but with a unique orange handling section. Features a quick change 8" loop at front end. This is a great choice for added distance. 30m spools.

4 Sizes: #7/8-25lbs-Blue, #8/9-35lbs-Green, #9/10-44lbs-Red, #10/11-50lbs-Yellow

Code 13A0207 £49.99



SCIENTIFIC ANGLERS

Scientific Anglers Floating Shooting Line

A super-slick coated shooting line with a braided multifilament core for exceptional distance and easier handling with fewer tangles. Welded loop on front end. 30.5m spools.

2 Sizes: .031"/20lbs, .038"/30lbs

Code 21A0066 £44.99



SCIENTIFIC ANGLERS

Scientific Anglers Absolute Flat Mono Shooting Line

A flat monofilament shooting line for ultimate distance casting with a rectangular profile to reduce line twist and increase grip in fingers. Hardness is tailored per size for optimal shooting with low memory in any condition and the vibrant colours are easily tracked at distance. 30m spools.

4 Sizes: 25lbs/Yellow, 35lbs/Oragne, 42lbs/Chartreuse, 50lbs/Optic Green

Code 21A0065 £19.99



RIO PRODUCTS

RIO Slick Shooter

A super hard, slick finish, oval-shaped nylon shooting line that has extremely low friction for long distance casts. 0.030"/44lbs/Red. 35m spool.

Code 13A0070 £19.99



airflo

Airflo Ridge 2.0 Running Line

Airflo's Ridge 2.0 technology significantly improves line speed & shootability whilst reducing tangles associated with any low diameter running lines. Low stretch Powercore for unrivalled hook set and oversized flexi loops for quick and easy head changes.

3 Sizes: 20lbs, 30lbs and 50lbs

Code 23A0059 £44.99



GUIDELINE

Guideline Tapered Shooting Line (TSL)

A thin, tapered, floating shooting line with a harder and slicker polyethylene coating. A braided monofilament core reduces stretch and tangles, makes the line stiffer and improves casting performance. Large 10cm loop at front end and a smaller 1cm loop at rear. 30m spool.

3 Sizes: 0.028"/0.70mm/25lbs/Blue, 0.031"/0.80mm/35lbs/Sunrise, 0.034"/0.86mm/35lbs/Green

Code 20A0058 £54.99



ACCESSORIES

RIO PRODUCTS

RIO Cranky Kit

A quick and convenient fly line spooling and storage station that includes one RIO Cranky (featuring ergonomically shaped handles for a smooth comfortable operation) and a RIO fly line spool.

Code 15B0065 £9.99



OmniSpool Switch Box, Crank Handle & Line Care Box

A simple, inexpensive solution to keeping, storing, changing and even cleaning your fly lines.

Thread your fly line onto the spool of the Switchbox and use the crank handle to wind it on. They're stackable so you can keep all of your fly lines neatly stored in one spot. There's even a place for a Line Care Box to clip on. Ideal for the travelling angler.

Switch Box (Blue or Green) **£15.99**
Crank Handle **£8.99** Line Care Box **£13.99**

Code 13A0087



C&F Shooting Head Dispenser

- Lightweight and compact storage for your shooting heads
- Holds two shooting heads or fly lines
- Very easy to use, rewind and install shooting heads

Code 70100 £34.99



RIO Headcase

A convenient zipped bag containing a ring binder with ten heavy duty zip-lock pouches, and two zipped interior mesh pockets as well. This is the ultimate storage case for shooting heads. Additional sets of five bags are available.

Code 13A0072 £49.99
Set of 5 Bags **£9.99**

MOW TIPS

RIO Skagit MOW Tips - 10ft

These 10ft MOW tips allow anglers using Skagit lines and short Spey rods of less than 13ft to cover every likely fishing situation and condition. Built on an ultra-low stretch core with welded loops at both ends and individually laser printed IDs for easy identification.

3 Sizes:

Medium (T11-8ips) for Skagit heads of less than 575 grains
 Heavy (T14-9ips) for Skagit heads between 575 grains and 675 grains
 Extra Heavy (T17-10ips) for Skagit heads of more than 675 grains

Code 22A0044

Density of Tip	Medium T11	Heavy T14	Extra Heavy T17
10ft Full Floating	£29.99	£29.99	£29.99
7.5ft Float + 2.5ft Sink	£29.99	£29.99	£29.99
5.0ft Float + 5.0ft Sink	£29.99	£29.99	£29.99
2.5ft Float + 7.5ft Sink	£29.99	£29.99	£29.99
10ft Full Sink	£29.99	£29.99	£29.99
12.5ft Full Sink	£29.99	£29.99	£29.99



RIO Skagit iMOW Tips - 10ft

RIO Skagit 10ft iMOW tips are designed to cast the biggest of flies with exceptional ease and are built with an intermediate back section attached to a varied length of either fast sinking Medium (T11-8ips) or Heavy (T14-9ips). Built on an ultra-low stretch core with welded loops at both ends and individually laser printed IDs for easy identification.

2 Sizes:

Medium (T11-8ips) for Skagit heads of less than 575 grains
 Heavy (T14-9ips) for Skagit heads of more than 575 grains

Code 22A0045

Density of Tip	Medium T11-8ips <575 grains	Heavy T14-9ips >575grains
10ft Full Intermediate	£29.99	£29.99
7.5ft Intermediate + 2.5ft Sink	£29.99	£29.99
5.0ft Intermediate + 5.0ft Sink	£29.99	£29.99
2.5ft Intermediate + 7.5ft Sink	£29.99	£29.99



RIO InTouch Long MOW Tips

These powerful 15ft Long MOW Tips are designed to cast large flies and are perfect for rods of 13ft 6ins and longer, and for casters that find regular MOW tips too short. Available in 3 sizes (Medium, Heavy and Extra Heavy) and in a multitude of densities.

3 sizes:

Medium T11 - For lines between 475 grains and 575 grains
 Heavy T14 - For lines between 575 grains and 650 grains
 Extra Heavy T17 - For lines over 650 grains

Code 20A0116

Density of Tip	Medium T11	Heavy T14	Extra Heavy T17
15ft All Floating	£29.99	£29.99	£29.99
10ft Floating+ 5ft Sinking	£29.99	£29.99	£29.99
5ft Floating + 10ft Sinking	£29.99	£29.99	£29.99
2.5ft Floating+ 12.5ft Sinking	£29.99	£29.99	£29.99
15ft All Sinking	£29.99	£29.99	-



RIO InTouch 10ft 3D MOW Tips

Powerful, multi-density, 10ft RIO 3D MOW tips with 3ft of the 1st & 2nd sinking sections and 4ft of the fastest sinking end section. Built on RIO's ConnectCore for ultra-low stretch performance. Perfect with RIO's Skagit Max Game Changer and other Skagit lines. Medium <575gr and Heavy >575gr

Code 19B0019

3 Densities	Medium	Heavy
Int/S3/S4	£29.99	£29.99
S3/S4/S5	£29.99	£29.99
S5/S6/S7	£29.99	£29.99



VERSITIPS

RIO InTouch 10ft VersiTips

Replacement tapered tips for RIO VersiTip, Scandi and Skagit lines. Each tip has a colour coded loop and is printed with the tip size and weight.

Code 17A0078 10ft Tips (5wt-9wt)

Sink Rate	Loop Colour	10ft
Floating	Straw	£29.99
Intermediate	Lt. Grey	£29.99
Sink 3ips	Yellow	£29.99
Sink 6ips	Grey	£29.99



RIO InTouch 15ft VersiTips

Replacement tapered tips for RIO VersiTip, Scandi and Skagit lines. Each tip has a colour coded loop and is printed with the tip size and weight.

Code 15A0039 15ft Tips (8wt-10wt)

Sink Rate	Loop Colour	15ft
Floating	Straw	£29.99
Intermediate	Lt. Grey	£29.99
Sink 3ips	Yellow	£29.99
Sink 6ips	Grey	£29.99
Sink 8ips	Green	£29.99



VERSI LEADERS



RIO 7ft Trout VersiLeaders

Designed for the trout angler who needs a quick change from a floating line to a sink tip. Each 7ft Trout VersiLeader is tapered for the best in casting performance and presentation and has a 12lb core coated in PVC with a neat, colour-coded, bullet-proof welded loop at the butt end.

Code 23A0035

Sinking Rate	Loop Colour	7ft
Floating	Clear	£13.99
Intermediate 1.5ips	Clear	£13.99
Slow Sinking 4ips	Red	£13.99
Fast Sinking 6ips	Grey	£13.99



RIO 10ft Spey VersiLeaders

A great addition to Spey lines and Scandinavian style shooting heads, giving the angler a wide range of quick-change depth options. Strong (20/25lb) 10ft, PVC coated, nylon tapered leaders. Strong, slim, colour coded, welded loop at the butt end. Medium Spey VersiLeaders for heads and lines of less than 450 grains / #8. Heavy for heads and lines of greater than 450 grains / #8.

Code 23A0036

Sinking Rate	Loop Colour	Medium	Heavy
Floating	Clear	£15.99	£15.99
Intermediate 1.5ips	Clear	£15.99	£15.99
Slow Sinking 4ips	Red	£15.99	£15.99
Fast Sinking 6ips	Grey	£15.99	£15.99

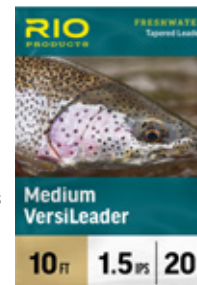

FLY LINE TREATMENTS

Scientific Anglers Fly Line Dressing and Pad - The Best!

- Formulated to last longer and to stay on your fly line longer than other dressings
- Improves floatability for easier pickup and mending
- You can use your line immediately
- Includes a two-sided cleaning pad



Code 11249 £19.99

Sportfish Fly Line Cleaning Pad

A spongy pad to use with any cleaner to clean your fly lines.

Code 27433 99p

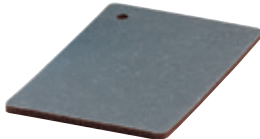

Lee Wulff Line Dressing

This fly line dressing is formulated especially for Lee Wulff lines. Dries to a hard, slick finish that stays clean.

Code 11250 £14.99



Loon Line-Up Kit

A brilliant kit to help you clean and protect your line all in one go. Simply apply the Loon Line Speed to the sheepskin pads within the hinged wooden holder and run your line through the pads. A bottle of Loon Line Speed cleaner is included.

Code 60451 £16.99



RIO Agent X

Specially formulated for RIO fly lines.

Code 10524 £9.99



Watershed

Provides a permanent waterproof coating on flies, material, dubbing, yarn & even nylon leaders. An amazing waterproofing agent.

Code 90318 £7.79



Red Mucilin

A solid floating fly line dressing without any silicone. Supplied with a soft applying pad.

Code 11377 £2.49



Green Mucilin

A solid floating fly line dressing with added silicone. Supplied with a soft applying pad.

Code 23A0102 £2.49



Snowbee Slick Fly Line Treatment

A silicone-based lubricant for floating fly lines which reduces friction through the rings ensuring longer casts. Helps protect fly lines from damage and from the effects of harmful chemicals. 15ml.

Code 27751 £4.99



Loon Line Speed

Line Speed cleans and protects lines and other surfaces, forming a durable, slick, repellent coating. A fly line treated with Line Speed has less drag on the water for easier retrieval.

Code 11246 £9.99



Zap-A-Gap

The best waterproof fishing super glue ever! Comes in a traditional 1/2oz dropper bottle. It's great for attaching braided loops to fly lines and countless other uses in fishing, fly tying and general repairs on just about any material. Fast drying and resistant to saltwater.

Code 11265 £6.99



Zap-A-Gap Brush-On Fishing Glue

The ideal waterproof fishing superglue with 100s of uses from attaching loops, strengthening knots, fixing rod tips to fly tying etc. Complete with easy brush-on applicator. 1/4 oz bottle.

Code 90135 £6.49



Zap-A-Gap Fishing Glue Vest 2-Pack

Perfect size to slip into your fishing vest or pocket. Pack of two 0.10oz bottles.

Code 90180 £5.49



Fulling Mill Super Glue

High performance glue for a variety of uses, fly dressing, instant tackle repairs, fly line loop preparation and waterside back up. Includes a handy brush, in an anti-spill bottle.

Code 27773 £7.25



RIO Wonder Cloth 4-Pack

Treat your fly line every few trips with RIO Agent X and this micro abrasive cleaning cloth that strips out deep-lying dirt without damaging the fly line.

Code 18A0147 £4.99 4-Pack



RIO Fly Line Cleaning Towlette

A disposable cloth pre-coated with silicone that quickly cleans your fly line and enhances its performance.

Code 18A0148 99p



FLY LINE WINDERS

Quick Line Winder

Amazingly useful. This line winder allows you to transfer a fly line from its spool and onto your fly reel without having anyone else to assist you. In the same way, it can be used for transferring nylon from a spool onto a reel.

The plastic suction cup can be fixed to any flat surface and the spool is then held in position by a spring loaded retainer.

Code 11254 £12.99

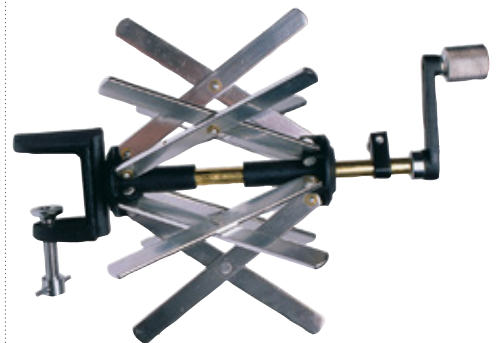

Fly Line Winder

- The best way to put new fly lines on reels
- Change lines quickly without tangles
- Clean and dress lines quickly
- Coil lines for compact storage
- Adjustable coil size
- Lightweight rustproof metal

Code 21B0045 £37.99

BACKING

RIO Coloured Dacron Backing

RIO's quality braided Dacron backing features high strength and low stretch. The hollow core makes it easy to knot and blind splice.

Code 23A0045

Length	20lbs/100yds	20lbs/200yds	30lbs/100yds	30lbs/300yds
White	£9.99	£15.99	£9.99	£24.99
Yellow	£9.99	£15.99	£9.99	£24.99
Blue	£9.99	£15.99	£9.99	£24.99
Black	£9.99	£15.99	£9.99	£24.99
Green	£9.99	£15.99	£9.99	£24.99
Pink	£9.99	£15.99	£9.99	£24.99
Red	£9.99	£15.99	£9.99	£24.99



RIO Gel Spun (GSP) Backing - 65lbs

A premium, strong, soft and smooth 8-carrier Gel Spun Polyethylene (GSP) backing with a round profile. This 65lbs GSP has approximately the same diameter as 20lbs dacron. The multicolour GSP changes colour every 10 meters.

Code 22B0039

Colour	65lbs / 200yds	65lbs / 300yds
Multicolour	£34.99	£49.99
Chartreuse	£34.99	£49.99
White	£34.99	£49.99



Orvis Dacron Backing

High quality, fine diameter, super smooth, round, braided Dacron line.

Colours: White or Orange

Code 20A0045

Length	20lbs White	20lbs Orange	30lbs White	30lbs Orange
100yds	£13.99	£13.99	-	-
200yds	£25.99	£25.99	£38.99	£38.99
300yds	£37.99	£37.99	-	-
400yds	-	-	£58.99	£58.99



Sportfish Braided Polyester Backing

Good quality standard backing suitable for most purposes.

Code 11A0237

Length	Lb.	Colour	Price
100m	20	White	£4.99
200m	20	White	£9.99
200m	30	White	£9.99



Orvis Gel Spun Backing - GSP

The backing choice of big fish anglers. Braided from gel-spun polyethylene this yellow ultra-thin and extremely abrasion-resistant line has virtually no stretch.

Code 20A0046

Length	30lbs Yellow	50lbs Yellow
250yds	£35.99	-
500yds	£72.99	£104.99
1000yds	£148.99	£208.99



BRAIDED LOOPS DIY

Sportfish Braided Monofilament

Ideal to make your own braided loops or as the running line for shooting heads or as general backing. 75 yds. 25lbs.

Available in:
Clear **£6.99**
Yellow **£7.99**

Code 11257



Cortland Braided Mono Looping Material - 50lb

Perfect for building your own leader loops and splicing fly lines. Ideal for loop to loop connections, sink tips, shooting heads and backing. White. 50lbs/100ft/30m.

Code 20A0022
£20.99



BRAIDED LOOPS



BEST SELLER

Roman Moser Minicon Braided Loops

The highest quality, slimmest loops made from a double wall of braid.

3 Options:
5 loops Trout **£6.99**
4 loops Salmon **£6.99**
3 loops Jumbo **£6.99**

Code 11351C



Sportfish Braided Loops

Ideal for loop-to-loop connections between fly line and leader. Can also be used for connection between fly line and backing. 3 loops and sleeves.

2 Options: Clear Trout, Clear Salmon

Code 11266 £1.99

RIO Braided Loops

These high quality braided loops feature a double thickness of braid around the formed loop for superior strength and energy transfer. 4 per pack.

Colour: Translucent white

3 Sizes: Trout, Salmon, Shooting Head

Code 17A0509 £6.99

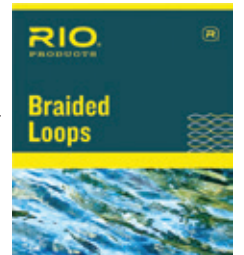

Vision Braided Nano Loops

Custom-made braided nano loops. 4 per pack.

Four sizes to cover all possible line weights.

Code 21B0084



Size	lbs	Line Size	Price
Small	15lbs	WF1-5	£7.99
Medium	25lbs	WF6-8	£7.99
Large	35lbs	Salmon	£8.99
XLarge	45lbs	Shooting Head	£8.99

DAPPING FLOSS

Veniard's Dapping Floss/Blow Line

A high quality, multi-strand, floss blow-line specially designed for dapping anglers. An essential piece of tackle for those who enjoy fishing this unique and exciting method. 50m spool.

Code 22A0101 £6.99



LEADERS & TIPPETS FLUOROCARBON

Seaguar Ace Hard Fluorocarbon Tippet

Seaguar Ace has been specially formulated to give maximum abrasion resistance for salmon and saltwater game fishing whilst retaining the main properties of Rivege. This is the preferred leader material for both salmon and saltwater anglers.

My first choice fluorocarbon for both salmon and saltwater. Very reliable with great knot strength. A must for the serious angler.

DANNY R. NORTH
Sportfish

ASK THE EXPERTS

Code 25265

Dia (mm)	0.16	0.18	0.20	0.23	0.26	0.28	0.33	0.37	0.40	0.43	0.47	0.52
Lb.	5.5	6.6	8.8	11.6	13.6	15.4	19.1	23.5	25.5	30.0	35.0	44.0
50m spool	£13.99	£13.99	£13.99	£13.99	£13.99	£13.99	£14.99	£14.99	£15.99	£17.99	£20.49	£22.99



Seaguar Grand Max Fluorocarbon Tippet

The abrasion resistance and invisibility of Grand Max ensure that fish are neither spooked nor lost. Grand Max is slightly softer than Rivege fluorocarbon and has a higher breaking strain for diameter. It has been extensively tested and is the first choice fluorocarbon with many stillwater and river anglers. **Code 11284**

Size	8X	7X	6X	5X	4X	3X	2X	1X	0X	01X	02X
Dia (mm)	0.10	0.11	0.14	0.16	0.18	0.21	0.24	0.26	0.28	0.33	0.36
Lb.	2.4	3.5	4.7	6.0	7.5	9.5	12.5	14.5	16.5	18.0	22.0
30yd spool	£9.99	£9.99	£9.99	£9.99	£9.99	£9.99	£9.99	£9.99	£9.99	£9.99	£9.99
100yd spool	-	-	£26.99	£26.99	£26.99	£26.99	£26.99	-	-	-	-



Seaguar Soft Plus Fluorocarbon Tippet

Seaguar Soft Plus is from Kureha of Japan. This fluorocarbon is softer than Grand Max and is amazingly 10% stronger. Soft Plus has been extensively tested by some of the top trout fishermen in the country and has been proved 100% reliable. **Code 80027**

Size	5X	4X	3X	2X	1X	0X	01X	02X
Dia (mm)	0.16	0.18	0.22	0.23	0.26	0.28	0.33	0.37
Lb.	6.6	8.2	10.4	13.7	15.9	18.1	19.8	24.2
50m spool	£15.99	£15.99	£15.99	£15.99	£15.99	£16.99	£17.99	£17.99
100m spool	£26.99	£26.99	£26.99	£26.99	£26.99	£27.99	£29.99	£29.99



Seaguar Rivege Fluorocarbon Tippet

Rivege Fluorocarbon is slightly stiff and particularly suitable for fishing with droppers. It has greater rigidity for easy turnover. It is practically invisible in water and sinks readily without treatment at about 3 times the speed of nylon. The abrasion resistance and invisibility of Rivege ensures that fish are neither spooked nor lost. **Code 11283**

Size	7X	6X	5X	4X	3X	2X	1X	0X	01X	02X	03X
Dia (mm)	0.11	0.14	0.16	0.18	0.21	0.24	0.26	0.28	0.33	0.36	0.39
Lb.	3.0	3.5	5.0	7.0	9.0	12.0	14.0	15.0	16.0	19.0	22.0
30yd spool	£7.75	£7.75	£7.75	£7.75	£7.75	£7.75	£7.75	£7.75	£7.99	£7.99	£7.99
100yd spool	£22.99	£22.99	£22.99	£22.99	£22.99	£22.99	£22.99	£22.99	£23.99	£23.99	£23.99



Fulling Mill Masterclass Fluorocarbon Tippet

Fulling Mill's Masterclass fluorocarbon brings a technical revolution into your tackle bag with a super-strong and super-thin pure fluorocarbon. Supple and easy to knot with great knot strength it is suitable for all fishing disciplines including trout, salmon and saltwater. Supplied on a convenient, simple, large arbor spool with a silicone pro retaining band. Made in Germany. **Code 18A0068**

Size	6X	5.5X	5X	4X	3X	2X	1X	0X	01X	02X	03X	04X
Dia (mm)	0.12	0.14	0.16	0.18	0.20	0.23	0.26	0.27	0.30	0.32	0.36	0.38
Lb.	3.7	4.2	5.0	6.5	7.1	10.7	12.2	13.1	15.3	17.5	20.9	23.2
50m spool	£16.50	£16.50	£16.50	£16.50	£16.50	£16.50	£18.50	£18.50	£18.50	£18.50	-	-
40m spool	-	-	-	-	-	-	-	-	-	-	£18.50	£18.50



Airflo Sightfree G3 Fluorocarbon Tippet

The tippet of choice for many anglers all around the world because of its superior knot strength and abrasion resistance. Sightfree G3 is almost invisible in water and helps you put more fish on the bank. Perfect for the stillwater and reservoir angler.

Code 20A0121

Size	7X	6X	5X	4X	3X	2X	1X
Dia (mm)	0.13	0.14	0.16	0.18	0.19	0.21	0.23
Lb.	3.0	4.0	5.0	6.0	7.0	8.0	10.0
RRP	£24.99	£24.99	£24.99	£24.99	£24.99	£24.99	£24.99
100m spool	£12.49	£12.49	£12.49	£12.49	£12.49	£12.49	£12.49



SPECIAL OFFER HALF PRICE

RIO Fluoroflex® Strong Fluorocarbon Tippet

An ultra-strong supple 100% fluorocarbon with exceptionally high tensile strength. Fluoroflex® Strong is very easy to tie knots in, with high knot strength and a smooth finish that ensures knots seat easily and tightly. The high breaking strength to diameter ratio makes this a fantastic fluorocarbon for the serious angler.

Code 21A0001

Size	6X	5X	4X	3X	2X	1X	0X	20LB	25LB	30LB
Dia (mm)	0.127	0.152	0.178	0.203	0.229	0.254	0.279	0.381	0.432	0.483
Lb.	3.8	5.2	7.3	8.8	11.2	13.3	15.5	20.0	25.0	30.0
30yd spool	£17.99	£17.99	£17.99	£17.99	£17.99	£17.99	£17.99	£24.99	£24.99	£34.99
110yd spool	£39.99	£39.99	£39.99	£39.99	£39.99	£39.99	£39.99	-	-	-



Fulling Mill World Class V2 Fluorocarbon Tippet

This updated Fulling Mill World Class V2 fluorocarbon is a real workhorse for your tackle bag. It is tough, reliable, holds its knot strength, does not suffer from abrasion and is exceptional value for money. Favoured by many competition anglers for its superior performance and consistency. Supplied with a convenient cotton retainer band.

Code 11286

Size	5x	4x	3x	2x	1.5x	1x	0x	01x	02x
Dia (mm)	0.15	0.17	0.19	0.21	0.23	0.25	0.27	0.29	0.34
Lb.	3.0	4.0	5.0	6.0	7.0	8.0	10.0	12.0	15.0
50m spool	£7.25	£7.25	£7.25	£8.25	£8.25	£8.25	£11.25	£11.25	£11.25
100m spool	£11.75	£11.75	£11.75	£13.50	£13.50	£13.50	£18.50	£18.50	£18.50



Frog Hair Fluorocarbon Tippet

Unlike other fluorocarbons that are very rigid and stiff, Frog Hair Fluorocarbon is processed to increase the flexibility of the material and provide up to two times the suppleness of other fluorocarbon. The added suppleness complements the refractive qualities of fluorocarbon to deliver the most stealthy, drag-free presentation possible and increase your catch rate.

Code 80012

Size	6x	5x	4x	3x	2x	1x	0x	01x	02x	03x
Dia (mm)	0.12	0.15	0.17	0.20	0.22	0.25	0.27	0.33	0.38	0.48
Lb.	3.3	4.4	6.6	8.8	10	11.5	13.2	17.6	22(20m)	35(20m)
25m spool	£10.99	£10.99	£10.99	£10.99	£10.99	£10.99	£10.99	£10.99	£13.99	£13.99
100m spool	-	-	£32.99	£32.99	£32.99	£32.99	-	-	-	-



Snowbee XS-Plus Gold Super Fluorocarbon Tippet

Quality fluorocarbon, incorporating the latest in Japanese extrusion technology, provides a line as strong, smooth and abrasion resistant as anything on the market... and better than most. The silky-smooth finish helps maintain its ultra-low refractive index, plus provides the outstanding knot-strength to diameter ratio.

Code 22A0046

Size	5X	4X	3X	2X	1X
Dia (mm)	0.16	0.18	0.20	0.22	0.24
Lb.	5.5	6.5	7.5	8.5	10.5
50m spool	£10.99	£11.99	£12.99	£13.99	£14.99



Drennan Sub Surface Green Tippet

One of our most popular sub surface monofilament tippet materials which offers high knot strength and delicate presentation. Drennan sub surface can be used for virtually all disciplines of fly fishing from presenting a dry fly on a clear shallow river right through to large reservoir lure fishing. *40m spool

Code 11306

Dia (mm)	0.18	0.20	0.22	0.25	0.28	0.30	0.35
Lb.	3.0	4.0	5.0	6.0	8.0	10.0	12.0*
50m spool	£3.95	£3.95	£3.95	£3.95	£3.95	£3.95	£3.95



Drennan Double Strength Tippet

As the name suggests Drennan Double Strength is double the strength of similar lines at the stated diameters. Very popular fine diameter leader material so you get an accurate breaking strain with half the normal diameter and very little stretch. Colour - Green.

Code 11308

Dia (mm)	0.13	0.14	0.15	0.17	0.19	0.21	0.22	0.24
Lb.	2.75	3.6	4.0	5.0	6.0	7.0	8.0	10.0
50m spool	£4.95	£4.95	£4.95	£4.95	£4.95	£4.95	£4.95	£4.95



LEADERS & TIPPETS COPOLYMER/NYLON

RIO Powerflex Copolymer Tippet

A copolymer tippet that features superb knot strength, stretch and suppleness making this the ideal tippet for all salmon and trout fly fishing needs. Powerflex tippet has a PTFE coating that helps knots slide up tight without damaging or crinkling the tippet. The light grey colour enhances its camouflage ability in the water.

Code 11298

Size	7x	6x	5x	4x	3x	2x	1x	0x	20LB
Dia (mm)	0.10	0.13	0.15	0.18	0.20	0.23	0.25	0.28	0.33
Lb.	2.4	3.4	5.0	6.4	8.2	10.0	13.0	15.0	20.0
30yd spool	£5.49	£5.49	£5.49	£5.49	£5.49	£5.49	£5.49	£5.49	£5.49
110yd spool	-	£13.99	£13.99	£13.99	£13.99	£13.99	-	-	-



RIO Powerflex Plus Tippet

The strongest nylon copolymer tippet material ever made, with tensile strengths up to 20% more than regular tippet. A highly technical formulation of the nylon copolymer manufacturing process has resulted in this prodigious strength, without compromising knot strength or suppleness. Simply put, this is the strongest, most reliable tippet ever made.

Code 19A0024

Size	7x	6x	5x	4x	3x	2x	1x	0x
Dia (mm)	0.10	0.13	0.15	0.18	0.20	0.23	0.25	0.28
Lb.	2.7	4.0	6.0	7.5	9.5	12.0	15.0	18.0
50m spool	£11.99	£11.99	£11.99	£11.99	£11.99	£11.99	£11.99	£11.99



Frog Hair Copolymer Tippet

This copolymer achieves maximum breaking strain without sacrificing suppleness or elasticity. Lays down softly and turns flies over perfectly for gentle presentation and has exceptional knot strength. The UV block protects tippet from UV rays. Spools lock together for ease of use.

Code 80010

Size	7x	6x	5x	4x	3x	2x	1x	0x
Dia (mm)	0.10	0.13	0.15	0.18	0.20	0.22	0.25	0.28
Lb.	2.8	3.7	4.9	6.2	8.5	11.1	13.1	15.0
30m spool	£6.99	£6.99	£6.99	£6.99	£6.99	£6.99	£6.99	£6.99



Snowbee XS-Plus Gold Super Copolymer Tippet

A true, gold standard, premium range of copolymer incorporating the most advanced state-of-the-art technology on the market today. Providing a super smooth and approved diameter and tensile rating material with superb knot strength in all diameters. Medium suppleness and memory free. Coloured spool tenders for instant identification.

Code 22A0047

Size	8X	7X	6X	5X
Dia (mm)	0.09	0.12	0.15	0.17
Lb	2.1	3.7	5.0	6.5
50m spool	£6.49	£6.49	£6.49	£6.49



Maxima Monofilament Tippet

Still the most popular premium quality standard monofilament.

Code 11304

Dia (mm)	0.15	0.17	0.20	0.22	0.25	0.30	0.32	0.37	0.40	0.42
Lb.	3.0	4.0	5.0	6.0	8.0	10.0	12.0	15.0	18.0	20.0
50m Clear	£2.99	£2.99	£2.99	£3.29	£3.29	£3.29	£3.49	£3.99	£3.99	£4.99
50m Green	£2.99	£2.99	£2.99	£3.29	£3.29	£3.29	£3.49	£3.99	£3.99	£4.99
100m Green	-	£4.79	£4.79	£5.99	£5.49	£5.49	£5.79	£5.79	£6.49	£6.99
100m Chameleon	-	£4.79	£4.79	£5.99	£5.49	£5.49	£5.79	£5.79	£7.49	£8.49
200m Chameleon	-	-	-	-	-	£10.99	£10.99	£11.99	£11.99	£13.49
600m Chameleon	-	-	-	-	-	£22.99	£24.99	£24.99	£24.99	£24.99



Gigafish Ultra Power Monofilament Tippet

Gigafish Ultra Power monofilament has an amazing strength to diameter ratio. This is a modern, thinner and stronger alternative to traditional monofilament. Becoming very popular with salmon, trout and coarse anglers throughout Europe.

Code 15A0298

Dia (mm)	0.12	0.14	0.16	0.18	0.20	0.25	0.30	0.35	0.40
Lb.	3.7	4.8	6.2	7.5	9.9	15.2	19.6	26.9	33.8
Kg	1.7	2.2	2.8	3.4	4.5	6.9	8.8	12.2	15.3
100m spool	£7.99	£8.49	£8.99	£9.49	£9.99	£10.49	£10.99	£11.49	£11.99



**Sportfish
Recommends**

RIO Powerflex Trout Leaders - Single or Triple Pack

A reliable tapered copolymer leader with high knot strength and super abrasion resistance. The aggressive taper and long powerful butt section together with the soft, flexible front section provide excellent turnover with gentle presentation. Each leader is hand tied with a perfection loop. Available individually or in triple packs.

Code 11299

Size	6x	5x	4x	3x	2x	1x	0x
Dia (mm)	0.13	0.15	0.19	0.20	0.23	0.25	0.28
Lb.	3.4	5.0	6.4	8.2	10.0	13.0	15.0
9' leader	£5.49	£5.49	£5.49	£5.49	£5.49	£5.49	£5.49
9' triple pack	£13.99	£13.99	£13.99	£13.99	£13.99	-	-



RIO Powerflex Plus Trout Tapered Leaders - Double Pack

Simply put these are the strongest and most reliable trout leaders ever made with tensile strengths up to 20% more than regular leaders. A technical modification of the nylon copolymer formulation has resulted in a prodigious strength increase without compromising the knot strength or suppleness. Each leader has a hand tied perfection loop in the butt end for fast rigging.

Code 19A0025

Size	7x	6x	5x	4x	3x	2x	1x	0x
Dia (mm)	0.10	0.13	0.15	0.18	0.20	0.23	0.25	0.28
Lb.	2.7	4.0	6.0	7.5	9.5	12.0	15.0	18.0
9' Double Pack	£11.99	£11.99	£11.99	£11.99	£11.99	£11.99	£11.99	£11.99
12' Double Pack	£11.99	£11.99	£11.99	£11.99	-	-	-	-



Leeda Profil 9ft Tapered Leaders - Trout & Salmon

Our most popular 9ft clear monofilament tapered leaders are available once again. A super strong, stiff butt section tapers through to a fine delicate tip improving your fly turnover when casting. Pre-looped with a colour coded loop for easy identification.

Code 22B0001

Size	6X	5X	4X	3X	2X	1X	SAL	SAL	SAL
Dia (mm)	0.14	0.16	0.18	0.20	0.22	0.24	0.30	0.35	0.40
Lb.	2.0	3.0	4.0	5.0	6.0	7.0	12.0	15.0	17.0
9ft	£2.99	£2.99	£2.99	£2.99	£2.99	£2.99	£2.99	£2.99	£2.99



Leeda Profil SELECTA 15ft Tapered Leaders

A long, clear monofilament tapered leader with a large diameter butt section and a steep taper right to the tip ensures better turnover. The long 15ft tapered section can be cut back to suit your individual requirements. Pre-looped at the butt end.

Code 22B0009

Size	No.1 / 5X	No.2 / 3X	No.3 / 1X
Dia (mm)	0.13	0.20	0.24
Lb.	3.0	5.0	7.0
9ft	£2.99	£2.99	£2.99



Leeda Profil Tapered Leader with Two Droppers

A 9ft tapered leader with two pre-tied droppers ideal for presenting wet flies or a team of nymphs. Built with a super strong, stiff butt section to help turn over a team of three flies. Supplied with a hand tied loop at the front end.

Code 11311

Size	5x	4x	3x	2x	1x
Dia(mm)	0.15	0.17	0.19	0.20	0.25
Lb.	3.0	4.0	5.0	6.0	8.0
9'-2 Droppers	£2.75	£2.75	£2.75	£2.75	£2.75



Orvis Super Strong Plus Nylon Leaders - 2 Pack

The Orvis Super Strong Plus nylon leaders have superior knot strength and are a perfectly-balanced blend of elasticity, knot strength, abrasion resistance and suppleness combined with low stretch. Two leaders per pack.

Code 16A0060

Size	6x	5x	4x	3x
Lb.	3.3	4.9	6.0	8.5
7½'	£9.99	£9.99	£9.99	-
9'	£9.99	£9.99	£9.99	£9.99
12'	£9.99	£9.99	£9.99	-



LEADERS & TIPPETS LEADERS

Fulling Mill Masterclass Tapered Copolymer Leaders

The next generation tapered leaders formulated from advanced nylon copolymer material. The ideal addition to your fly line to help turn over any fly patterns, sizes or styles with ease. Pack of 1.

Code 19A0028

Size	7x	6x	5x	4x	3x	2x	1x	0x
Lb.	2.0	3.0	4.0	5.0	6.0	8.0	10.0	12.0
Dia (mm)	0.11	0.13	0.15	0.18	0.20	0.23	0.25	0.28
9'	£4.75	£4.75	£4.75	£4.75	£4.75	£4.75	£4.75	£4.75
12'	£4.75	£4.75	£4.75	£4.75	£4.75	£4.75	-	-



Frog Hair Supple Butt Trout Copolymer Leaders

Supple tip tapered leaders have an extra supple butt section to provide a tighter loop and a softer turnover for the stealthiest presentation possible. The ultra-supple tippet offers superior knot strength, incredible toughness, and built-in shock resistance with the most natural, drag-free presentation of any tapered leader. Perfection loop included.

Code 30013

Dia (mm)	7x	6x	5x	4x	3x	2x	1x	0x
Lb.	2.2	3.3	4.4	5.5	6.6	8.8	11.0	13.2
9.5'	£4.99	£4.99	£4.99	£4.99	£4.99	£4.99	£4.99	£4.99



RIO Salmon Copolymer Leaders

RIO 12ft leaders specifically designed for salmon fishing. This clear, non-glare knotless leader has a thicker butt of slightly stiffer copolymer that is perfect for throwing larger, heavier flies in the toughest of conditions.

Code 10226

Dia (mm)	0.28	0.31	0.35	0.38	0.43
Lb.	8.0	10.0	12.0	16.0	20.0
12'	£6.99	£6.99	£6.99	£6.99	£6.99



FLUOROCARBON LEADERS

Riverge Fluorocarbon Leaders

Riverge leaders are a softer material than the tippet material. The leaders have a high shock and knot strength, easy turnover, they repel water and are invisible in water.

Code 11292

Size	7x	6x	5x	4x	3x	2x	1x	0x	01x	02x	03x
Dia (mm)	0.12	0.14	0.16	0.19	0.21	0.24	0.26	0.29	0.33	0.36	0.39
Lb.	2.2	3.0	4.0	6.0	8.0	10.0	12.0	14.0	16.0	19.0	22.0
9'	£6.99	£6.99	£6.99	£6.99	£6.99	£6.99	£6.99	£6.99	£6.99	£6.99	£6.99



Seaguar Saltwater IGFA Fluorocarbon Leaders

Seaguar has taken its world renowned pure fluorocarbon tippet material and transferred it to a knotless tapered leader that is perfect for salmon and all saltwater species from bonefish to permit, stripers to jacks. Adheres to IGFA class regulations.

Code 80033

Lb.	8.0	10.0	12.0	16.0	20.0
9'	£6.99	£6.99	£6.99	£6.99	£6.99



Frog Hair Fluorocarbon Leaders

These leaders have a stiffer butt section to optimise the energy transfer from the fly line and a supple tippet that offers superior knot strength, incredible toughness, and built-in shock resistance to deliver a more stealthy, drag-free presentation compared to other fluorocarbon tapered leaders. Perfection loop included.

Code 80011

Dia (mm)	6x	5x	4x	3x	2x	1x	0x
Lb.	3.0	4.0	5.0	6.0	8.0	10.0	12.0
9'	£12.99	£12.99	£12.99	£12.99	£12.99	£12.99	£12.99

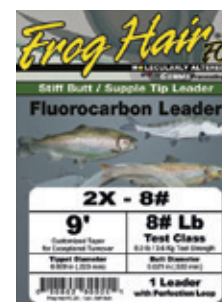

POLYLEADERS

airflo



Airflo PolyLeaders

Airflo PolyLeaders have a monofilament core surrounded by a tapered outer polymer which provides the fly fisherman with a tapered leader that almost turns over by itself! The monofilament core is exposed at the tip to allow you to add your favourite tippet material. Available in 5ft or 10ft lengths and a choice of seven densities. Floating, Hover, Intermediate, Slow-Sink, Fast-Sink, Super Fast-Sink and Extra Super Fast-Sink.

Code 11357

Also available in sets of 7 and save up to **£5.94**

Size	Light Trout 5ft	Trout 5ft	Trout 10ft	Salmon 5ft	Salmon 10ft
Clear Floating	£5.99	£5.99	£7.99	£5.99	£7.99
Clear Hover	£5.99	£5.99	£7.99	£5.99	£7.99
Clear Intermediate	£5.99	£5.99	£7.99	£5.99	£7.99*
Slow Sink	£5.99	£5.99	£7.99	£5.99	£7.99*
Fast Sink	£5.99	£5.99	£7.99	£5.99	£7.99*
Super Fast Sink	£5.99	£5.99	£7.99	£5.99	£7.99
Ex-Super Fast Sink	£5.99	£5.99	£7.99	£5.99	£7.99*
Set of 7	-	£39.99	£49.99	£39.99	£49.99

*Extra Strong

10FT SPEY VERSI LEADERS



RIO 10ft Spey VersiLeaders

A great addition to Spey lines and Scandinavian style shooting heads, giving the angler a wide range of quick-change depth options. Strong (20/25lb) 10ft, PVC coated, nylon tapered leaders. Strong, slim, colour coded, welded loop at the butt end. Medium Spey VersiLeaders for heads and lines of less than 450 grains / #8. Heavy for heads and lines of greater than 450 grains / #8.

Code 23A0036

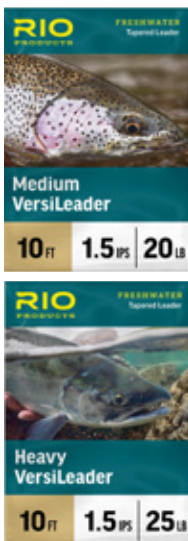

Sinking Rate	Loop Colour	Medium	Heavy
Floating	Clear	£15.99	£15.99
Intermediate 1.5ips	Clear	£15.99	£15.99
Slow Sinking 4ips	Red	£15.99	£15.99
Fast Sinking 6ips	Grey	£15.99	£15.99

SALTWATER LEADERS & TIPPETS

RIO Bonefish Leaders - 10ft Nylon

10ft medium-stiff nylon leaders. Perfect for the bonefish angler to deliver flies into strong winds. Hand tied perfection loop for quick rigging. Available in single or triple packs.

Code 20A0149

Dia (mm)	0.28	0.30	0.36
Lb	8.0	10.0	12.0
Single Pack	£6.99	£6.99	£6.99
Triple Pack	£17.99	£17.99	£17.99



RIO Saltwater Leaders - 10ft Nylon

Tough, abrasion resistant, medium-stiff, 10ft tapered nylon leaders with an easy casting taper design that casts large saltwater flies. Hand tied perfection loop for quick rigging.

Code 20A0150

Dia (mm)	0.26	0.30	0.36	0.41	0.46	0.51	0.56	0.61
Lb	8.0	10.0	12.0	16.0	20.0	25	30	40
Price	£6.99	£6.99	£6.99	£6.99	£6.99	£6.99	£6.99	£6.99



RIO Fluoroflex Bonefish/Saltwater Leaders - 9ft Fluorocarbon

Abrasion resistant, 9ft fluorocarbon leaders that are perfect for saltwater fishing in clear water with a long butt section for great turnover and presentation. Hand tied perfection loop for quick rigging.

Code 20A0151

Dia (mm)	0.23	0.25	0.28	0.33	0.38
Lb	8.0	10.0	12.0	16.0	20.0
Price	£15.99	£15.99	£15.99	£15.99	£15.99



RIO Toothy Critter 7.5ft Leaders

Each tapered leader has a bite tippet of nylon-coated stainless steel wire with a small stainless steel snap to change flies easily.

Code 17379

Lb	20.0	30.0	45.0
Kg	9.1	13.6	20.5
7.6ft	£10.99	£10.99	£10.99



Frog Hair Deep Blue 9.5ft Tarpon Leaders

These unique 9½' tarpon leaders feature a dual-tapered design that integrates a heavy butt with a pre-tied loop, class section and bite section.

Code 80015

Shock Tippet Lb	80lb	80lb
Class Lb	17.6	22.0
9.5'	£10.99	£10.99



RIO 12ft Tapered Tarpon Leaders (2 Pack)

Built on a long 40lb tapered section for improved turnover and presentation with a 2ft fluorocarbon shock tippet.

Code 19B0020

Class Leader	40lb
Shock Tippet	60lb Fluoro
Two Pack	£19.99



RIO Saltwater Mono Tippet

RIO's medium stiff saltwater monofilament has great strength-to-diameter ratio, abrasion resistance, little memory and incredible knot strength. Ideal as the butt section of any saltwater leader or tie straight through to large flies for big fish.

Code 16B0032

Dia (mm)	0.40	0.45	0.50	0.56	0.61	0.68	0.76
Lb	16	20	25	30	40	50	60
Price	£10.99	£10.99	£10.99	£10.99	£10.99	£10.99	£10.99



Berkley Trilene® Big Game™ Monofilament - Green

One of the most popular monofilaments due to its incredible strength, reliability and value.

Code 11A0361

Dia(mm)	0.35	0.38	0.45	0.48	0.55	0.60
Lbs	12	15	20	25	30	40
Length(yds)	1175	900	650	595	440	370
Price	£12.99	£12.99	£12.99	£12.99	£12.99	£12.99



Sufix Superior Mono Leader

A premium grade monofilament and a favourite choice of many fishermen due to its consistent, reliable performance. This specially blended copolymer nylon provides incredible linear strength, knot strength, low stretch and high abrasion resistance. 100m spools.

Code 19B0033

Kg	27	37	46	60	68k	9
Lb	59	81	101	132	150	201
Dia (mm)	0.7	0.8	0.9	1.0	1.2	1.4
Price	£8.49	£9.49	£10.49	£11.99	£14.49	£16.99



Berkley Trilene® Big Game™ Fluorocarbon

A favourite among big game anglers due to its near invisibility, dependability and high abrasion resistance.

Code 12A0042

Dia(mm)	0.61	0.81	0.91
Lbs	40	60	80
Length(yds)	100	75	75
Price	£26.99	£29.99	£29.99



FISHING GLUES

Zap-A-Gap

The best waterproof fishing super glue ever! Comes in a traditional 1/2oz dropper bottle. It's great for attaching braided loops to fly lines and countless other uses in fishing, fly tying and general repairs on just about any material. Fast drying and resistant to saltwater.

Code 11265 £6.99



Zap-A-Gap Brush On Fishing Glue

The ideal waterproof fishing superglue with 100s of uses from attaching loops, strengthening knots, fixing rod tips to fly tying etc. Complete with easy brush-on applicator. 1/4oz bottle.

Code 90135 £6.49



Zap-A-Gap Fishing Glue Vest 2-Pack

Perfect size to slip into your fishing vest or pocket. Pack of two 0.10oz bottles.

Code 90180 £5.49



Z-Poxy 5 Minute Formula

The world's finest 5 minute clear epoxy. Ideal for fly tying and smoothing out joints between fly line and leader or fly line and backing. Use to protect tinsel bodies. Cures in less than 5 minutes.

Code 10525 £19.99



Fishin' Glue Connection Kit

All you need for making braided loops.

Contains: Glue, acetone, splicing needle, clear tubing, braided mono and instructions.

Code 11264 £8.99



Loon UV Knot Sense

Clear liquid polyurethane which strengthens and smooths leader and backing joints. Fuses in seconds when exposed to direct sunlight.

Code 11263 £9.99



Loon UV Nano Light

Small yet powerful UV light, perfect for curing fly tying UV resins and Loon's Knot Sense and Wader Patch. Uses 1 AAA battery (included).

Code 19A0026 £21.99



WIRE LEADERS

Savage Gear Raw 49-Strand Knottable Wire

An uncoated, quality, stainless steel 49-strand wire (7x7) which is soft, flexible, easy to knot and has very little memory. Natural Brown. 10m spools.

Sizes: 24lbs, 35lbs or 50lbs

Code 17B0064 £12.99



Partridge Predator Leader Wire - W49

Knottable, flexible, sensitive and pliable nylon coated 49-strand stainless steel wire. Ideal as leader wire for all toothy predators. Camo. 5m.

Sizes: 30lbs, 40lbs

Code 18B0040 £10.99



American Fishing Wire - Surfion

A remarkable, knottable 49 strands camo nylon steel wire leader. 5m spools.

Sizes: 20lbs, 26lbs, 40lbs

Code 11A0033 £17.99



RIO Wire Bite Tippet

Tough, flexible nylon coated wire. Supple enough to tie on a fly with. 5m spools.

Sizes: 20lbs, 30lbs or 40lbs

Code 12A0031 £19.99



LEADER ACCESSORIES

Snowbee Fly, Leaders or Materials Wallets

These wallets have 100s of uses from carrying all your large saltwater or pike flies to storing leaders or to organising your fly tying materials. Each wallet holds 12 removable, waterproof and air-tight, self-seal bags. On the front is a mesh pocket for tools, leaders etc together with a belt loop and a clip.

Colour: Blue/Black

Size: 215 x 155 x 50mm

Code 90182 £21.99

Code 90182 £5.99

Magnetic Fly Threader

'The best fly threader in the world.'

- Very easy to use. Works with all flies from size 6 to 24!
- An essential tool for low light conditions and for those with less than perfect eyesight
- Magnetic notch firmly holds the eye in place
- The fly is perfectly aligned with the leader every time

Code 60465 £19.49



Riverge 2mm Leader Rings

Tie the end of your leader onto one of these rings and then tie your tippet length direct to the ring. They are also ideal for tying droppers to a leader. The rings weigh very little and don't affect turnover or the leaders' floating or sinking properties. Packet of 10.

Code 11502 £2.49



RIO Tippet Rings

Small, lightweight and strong. Supplied on a convenient swivel clip. 10 rings per pack.

Sizes:

Trout - 2mm - 25lbs

Salmon - 3mm - 45lbs

Code 15B0064 £9.99



Partridge Tippet Rings

Small, smooth and strong, these tippet rings are ideal for connecting to the end of your leader before adding your tippet or droppers. Essential also when making up Euro-nymph leaders. Black nickel. Pack of 10. Available in 3 sizes.

Sizes: 1.5mm, 2.0mm, 3.0mm

Code 21B0038 £4.49



Wheatley Leather Case

A leather case with 6 transparent pockets held in ring binder.

Size: 6 x 5".

Code 11330 £29.99

Pack of 6 extra transparent pockets. **£11.99**



Wheatley Plastic Case

Contains 10 empty cast carrier pockets. Does not include cast carriers.

Code 11329 £11.99



Wheatley Cast Carrier

Wheatley carrier with central magnet to hold flies.

Code 11331 £3.49



Mustad Fly Snap Hooks

Allows quick change of fly.

Size 1 for flies between 4-8

Size 2 for flies between 8-12

Size 3 for flies between 12-16

25 Snap Hooks per packet

Code 11503 £3.49



Fishpond Headgate Tippet Holder

Just clip it on somewhere close and forget about the days of fishing through your waders, vest or pack searching for those loose spools. The spring loaded hinge design allows you to easily add, remove and carry most tippet spools with ease.

Code 16A0088 £22.99

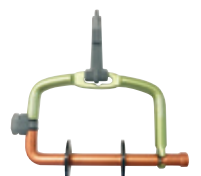

DRY FLIES MAYFLIES

G3 £2.10

 9792 McPhail Grey Wulff 10, 12 G3	 9797 McPhail Wet May 10, 12 G3	 740 Crippled Suspender Mayfly 10 G3	 704 French Partridge Mayfly 10 G3	 701 Green Drake Mayfly 10 G3	 2741 CDC Mayfly Dun BL 10, 12 G3
 9821 Jardine Mayfly Emerger 12 G3	 627 Spent May CDC 10 G3	 795 Connemara Mayfly 8, 10 G3	 717 Plastazole Brown Mayfly 10 G3	 PP122 Procter Loopwing Mayfly 10 G3	 PP121 Procter Mayfly Emerger 10 G3
 770 Baz's Mayfly 10 G3	 JK109 JT CDC Mayfly 10 G3	 700 Mayfly Parachute 10, 12 G3	 PP124 Procter Mayfly Spinner 10 G3	 780 Crippled Mayfly 12 G3	 2738 O.E Mohican May BL 10, 12 G3
 708 Shadow Mayfly 10 G3	 718 Silhouette Mayfly 10, 12 G3	 SD150 Spent Mayfly 10 G3	 784 Thomas Yellow Mayfly 10 G3	 783 Yellow Mayfly 10 G3	 705 Grey Wulff Mayfly 10, 12 G3
 8539 Jackie's Green Drake Fly 10 G3	 8542 Jackie's Mask Yellow Mayfly 10 G3	 8545 Jackie's Spent Pink Para Mayfly 10 G3	 8546 Jackie's Spent White Para Mayfly 10 G3	 9828 McPhail Spent Mayfly 10 G3	 9366 Mohican Mayfly 10 G3

DRY FLIES DADDIES

G3 £2.10

 793 Daddy Real Orange 10, 12 G3	 735 Real Daddy 10, 12 G3	 714 Dad's Natural 10 G3	 713 Daddy Longlegs 10, 12 G3	 719 Muddled Daddy 10, 12 G3	 736 Daddy CDC 10, 12 G3
 488 G/N Daddy Longlegs 10 G3	 764 G/N Daddy Orange Tag 10 G3	 744 Flexi Floss Daddy Black 10 G3	 792 Real Daddy Black 10 G3	 3034 Daddy Real Blue 10, 12 G3	 809 Daddyhog 10 G3

DRY FLIES HAWTHORNS, ANTS & BEETLES

G2 £1.65

G3 £2.10

 1065 Aero Hawthorn 12 G2	 515 Hawthorn 12, 14 G2	 513 Sparkle Hawthorn 12, 14 G2	 1736 Black Ant 14 G2	 560 Flying Ant Black 14 G2	 539 Ant Hi-Float 16 G2
 1059 Beetle Hi-Vis Black Foam 12 G2	 2954 Coch Y Bonduu Beetle 12 G2	 522 Carnhill's Foam Beetle 12 G2	 PP115 Kicking Beetle PeaCock 12 G2	 1553 BL Aero Red Legs 12 G3	 1064 Aero Red Legs 14 G2

DRY FLIES CADDIS & SEDGE

G1 £1.35

G2 £1.65

G3 £2.10













 8111 BL Croston's Mass Attack 12 G3	 9658 BL Roza's Green Butt CdC Caddis 14 G3	 1762 Sedge Black 10 G3	 2396 Sedgehog Bibio 10, 12 G1	 2757 Championship Caddis 13, 15 G3	 510 Grannom 14 G3
 9815 McPhail Bubble Wing Grannom 14, 16 G3	 2949 Chocolate Drop 12, 14 G2	 2734 Retirer Sedge 15, 17, 19 G3	 702 Goddard Amber 10, 12 G3	 3030 Barbless High Float Sedge 12, 14 G3	 892 Mini Sedge Black 18 G3
 1752 Elk Wing Grey 12, 14, 16 G3	 1755 Elk Wing Tan 12, 14, 16 G3	 2733 Balloon Sedgehammer 12, 14, 16 G3	 895 Ultimate Sedge 12, 14 G3	 886 High Rider CdC Olive 12, 14 G3	 2950 Olive Drop Sledge 12, 14 G2

T = Tactical Range - Specialist barbless flies

FLIES DRY FLIES

DRY FLIES WINGED

G3 £2.10

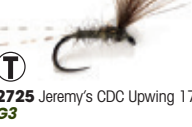
 8556 Ronan's Indicator Fly 12, 14 G3	 686 BL Jingler March Brown 12 G3	 9862 BL OE Mohican March Brown 14 G3	 1723 Black Gnat 14, 16, 18 G3	 1739 Blue Winged Olive 14, 16, 18 G3	 1741 Brown Mayfly 12 G3
 1761 Rusty Spinner 16 G3	 2873 FB Yellow May Dun 15, 17 G3	 8110 BL Croston's Crippled Spinner 16 G3	 1724 Blue Dun 14, 16 G3	 508 Coachman 14 G3	 511 GRHE 14, 16 G3
 512 Greenwells Glory 14, 16, 18 G3	 1766 Compara Dun Olive 14, 16, 18 G3	 503 Black Gnat 14, 16, 18 G3	 506 Blue Winged Olive 14, 16 G3	 9926 Barbless Duo Caddis 12, 14 G3	 526 Pale Watery Dun 16 G3
 531 Sherry Spinner 14, 16 G3	 518 Iron Blue Dun 14, 16 G3	 520 Large Dark Olive 14, 16 G3	 521 Lunn's Particular 14, 16 G3	 730 Coenis 20 G3	 731 Halford's Black Gnat 20, 22 G3
 SD183 Spinner Black 18 G3	 534 Wickham's Fancy 14, 16 G3	 8142 BL Roza's Pearl Butt Secret 16 G3	 1721 Adams 12, 14, 16, 18, 20 G3	 1866 Adams Thorax 14, 16 G3	 2725 Jeremy's CDC Upwing 17, 19 G3

DRY FLIES KLINKHAMMERS, PARACHUTES & EMERGERS

G2 £1.65

G3 £2.10

 PP152 Kicking Klink Olive 12 G3	 PP150 Kicking Klink Black 12 G3	 9804 McPhail Grunter Olive 12 G3	 1671 Parachute Black Suspender 14 G2	 1788 Deer Hair Emerger Hare's Ear Suspender 14 G2	 1789 Deer Hair Emerger Peacock Suspender 14 G2
 543 Klinkhammer Light Olive 12, 14, 16 G3	 1874 Parachute Hare's Ear Natural 14 G3	 599 Klink Indicator 14, 16 G3	 2731 Black Magic Klink Bless 16 G3	 1813 Adams 12, 14, 16, 18, 20 G3	 1841 Flexi Black 14 G3
 2866 Grannom Emerger 14, 16 G3	 1853 Black Gnat 14, 16 G3	 1867 Blue Winged Olive Thorax 16, 18 G3	 2752 SR Klink Duo Special 12, 14 G3	 2732 Oppo Parachute 14, 16, 18 G3	 366 Shipman's Buzzer Black 12, 14 G2
 1843 Flexi Olive 14 G3	 386 Bob's Bits Black 12 G2	 540 Klinkhammer Adam's Grey 12, 14, 16 G3	 541 Klinkhammer Caddis Green 12, 14, 16 G3	 544 Klinkhammer Rust 12, 14, 16 G3	 545 Klinkhammer Tan 12, 14, 16 G3
 548 Klinkhammer Black 12, 14, 16 G3	 1793 Goddard Olive Emerger 14, 16 G2	 720 Greenwells 14, 16 G3	 2729 Parachute Adams 17, 19 G3	 722 Iron Blue 14, 16 G3	 723 Pheasant Tail 14, 16 G3
 TG120 Terry's Emerger 12, 14, 16 G3	 TG122 Terry's Emerger Olive 14, 16 G3	 AK107 AK CDC Para Emerger Olive 14, 16 G2	 2730 Minnikin's Paradun Olive 17, 19 G3	 2874 Tutti Fruity Klink 12, 14 G3	 543 Klinkhammer Light Olive 12, 14, 16 G3

T = Tactical Range - Specialist barbless flies

DRY FLIES CDC

G2 £1.65

G3 £2.10

 8143 BL Roza's CdC Olive 14 G3	 1089 BL Black Mirage Buff Cul 12 G3	 2343 Shipman's CDC Hare's Ear 12 G2	 2351 CDC Claret Hopper 12 G2	 2352 CDC Black Hopper 12 G2	 2353 CDC Bibio Hopper 12 G2
 2966 KJ Olive Emerger 14 G2	 684 BL Quill Owl Cul 14 G3	 853 Dark Olive 14, 16 G2	 651 F Fly Black 14, 16, 18 G2	 653 F Fly Hare's Ear 14, 16, 18 G2	 655 F Fly Olive 14, 16, 18 G2
 839 Olive Emerger 16 G2	 2342 Shipman's CDC Black 12 G2	 VK135 Once & Away 14 G2	 9818 BL McPhail CdC Olive 16 G3	 855 Taffs CDC Light Olive 14 G2	 860 CDC Black Red Buff Shuttlecock 14 G2
 840 Yellow Owl CDC 14 G2	 864 CDC Hare's Ear Shuttlecock 14 G2	 867 CDC Buzzer Black Shuttlecock 14 G2	 868 Black Mirage Buff Cul 14 G2	 869 Pheasant Tail Mirage Buff Cul 14 G2	 2340 Shipman's CDC Claret 12 G2

DRY FLIES SPECIAL CDC

G2 £1.65

G3 £2.10

 628 CDC Olive Spinner 16 G3	 632 CDC Iron Blue Dun 16 G3	 641 Transitional Dun BWO 16 G3	 JK111 CDC Olive Dun 14, 16 G3	 9945 BL Rozas Quill V-Wing 16 G3	 CJ120 CJ's Ducks Dun 14, 16, 18 G3
 1088 Quill Plume BL 17, 19 G3	 2883 BWO Split Wing Dun 15 G3	 2832 Yellow May CDC 12 G2	 TG150 Wulff CDC Grey 10, 12 G3	 2726 Jeremy's Moley F-Fly 17, 19 G3	 2747 March Brown CDC 15 G3

DRY FLIES SPECIAL

G2 £1.65

G3 £2.10

 3015 KL Claret Pulling Hopper 10 G2	 9861 BL OE Mohican Yellow May Dun 14 G3	 1775 Black & Orange Chernobyl Ant 8 G2	 1061 Foam Hopper Tan 10 G2	 1808 Wulff Grey 10, 12, 14, 16 G3	 1811 Wulff Royal 10, 12, 14, 16 G3
 1805 Drop Arse Gnat 14, 16 G3	 712 Dad's Demoiselle 10 G3	 2724 Barry's Red Tag BL 17, 19 G3	 1852 Wulff Green Drake 10, 12 G3	 1862 Humpy Yellow 12, 14, 16 G3	 1863 Irresistible Adams 12, 14, 16 G3

DRY FLIES HACKLED







































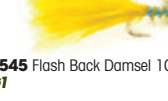
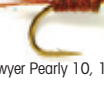

G1 £1.35

G3 £2.10

 2961 Bibio Palamino 12 G1	 1806 Drop Arse Spinner Olive 14, 16 G3	 1780 Griffiths Gnat Grayling Spcl 14, 16, 18 G3	 1822 Midge Black 20 G3	 602 Beacon Beige 14, 16 G3	 608 Coch-Y-Bondu 14, 16 G3
 2106 Red Tag 16, 18 G3	 2748 Griffiths Sparkle Gnat BL 19, 21 G3	 610 GRHE 14, 16 G3	 612 Grey Duster 14, 16 G3	 615 Iron Blue Dun 14, 16 G3	 616 Kites Imperial 14, 16 G3
 617 Large Dark Olive 14 G3	 620 Pheasant Tail 14, 16 G3	 621 Rough Olive 14, 16 G3	 623 Tup's Indispensable 14, 16, 18 G3	 2106 Red Tag 16, 18 G3	 2748 Griffiths Sparkle Gnat BL 19, 21 G3

Ⓣ = Tactical Range - Specialist barbless flies

FLIES DRY FLIES/WET FLIES/NYMPHS





















DRY FLIES HOPPERS						G2 £1.65	G3 £2.10
 2357 Half Hog Black & Red 10, 12 G2	 2560 Helpless Hopper Black 10, 12 G2	 2563 Hopper Popper Claret 10 G2	 2564 Hopper Popper Black 10 G2	 2565 Hopper Popper Orange 10 G2	 2566 Hopper Popper Amber 10 G2		
 749 Hopper Bibio 10, 12 G2	 750 Hopper Black 10, 12 G2	 751 Hopper Ginger 12 G2	 752 Hopper Claret/Pearl 10, 12 G2	 757 Hopper Black Nugget 10 G2	 9832 McPhail Big Red 10, 12 G3		
WET FLIES HACKLED WETS						G1 £1.35	G2 £1.65
 2640 Black Leggy 10 G1	 9802 McPhail Leggy Dabblers Claret 10, 12 G2	 205 Black Pennell 10, 12, 14 G1	 207 Black Zulu 10, 12 G1	 208 Blue Zulu 10, 12 G1	 210 Coch-Y-Bondhu 12, 14 G1		
 259 Clan Chief 10, 12 G1	 9801 McPhail Leggy Dabblers Olive 10, 12 G2	 204 Black & Peacock Spider 10, 12, 14 G1	 212 Greenwells Spider 14 G1	 213 Partridge & Orange 12, 14 G1	 216 Soldier Palmer 12 G1		
 202 Bibio Size 10, 12 G1	 217 Snipe & Purple 12, 14 G1	 219 Loch Ordie 10, 12 G1	 220 Bumble Claret 10, 12 G1	 224 Kate McLaren 10, 12 G1	 259 Clan Chief 10, 12 G1		
WET FLIES WINGED WETS						G1 £1.35	
 103 Alexandra 10, 12 G1	 121 Invicta 10, 12 G1	 107 Bloody Butcher 10, 12 G1	 110 Butcher 10, 12 G1	 113 Connemara Black 10, 12 G1	 114 Dunkeld 10, 12 G1		
 128 Peter Ross 10, 12 G1	 124 Mallard & Claret 10, 12 G1	 117 Greenwells Glory 12, 14 G1	 130 Silver Invicta 10, 12 G1	 133 Teal Blue & Silver 10, 12 G1	 136 Wickham's Fancy 10, 12 G1		
NYMPHS DAMSEL & MAYFLIES						G1 £1.35	G2 £1.65
 426 Walker Mayfly Weighted 10, 12 G1	 PC114 Blue Damsel Nugget 10, 12 G2	 1668 Hot Head Damsel Green 10 G2	 1704 Damsel Marabou Dark Olive Weighted 10, 12 G1	 2137 Glisters Damsel Olive 10 G1	 2138 Glisters Damsel Olive/Orange 10 G1		
 2159 Nugget Damsel Straggle 10 G2	 2161 Hot Damsel Straggle Orange 10 G2	 2162 Hot Damsel Straggle Green 10 G2	 2451 Dark Olive Living Damsel 10, 12 G2	 2545 Flash Back Damsel 10 G1	 CJ105 Down N Dirty Olive Damsel 10 G2		
NYMPHS PHEASANT TAILS & DIAWL BACHS						G1 £1.35	G2 £1.65
 401 Sawyer Pearly 10, 12, 14 G1	 411 Sawyer Original 12, 14, 16, 18 G1	 407 Sawyer Orange Spot 12, 14 G1	 445 Sawyer Flashback Pheasant Tail 14, 16 G1	 321 Natural PT 10, 12, 14 G1	 421 Natural PT Weighted 10, 12 G1		
 8483 KJ Pearl Hot Head Diawl 10, 12 G2	 2918 BL Red Holographic Diawl Bach 10, 12 G2	 2976 KJ Super Diawl Bach 10, 12 G1	 159 Hot Head Diawl Bach 10, 12 G1	 646 Diawl Bach Marabou 10, 12 G1	 161 JC Hot Head Diawl Bach 10, 12 G1		
 167 Holo Diawl Bach Red 10 G1	 169 Diawl Bach Black 10, 12 G1	 170 Diawl Bach Pearl 10, 12 G1	 187 Muskin's Rust 10, 12 G1	 188 Muskin's Black 10, 12 G1	 810 3D Green Diawl Bach 10, 12 G1		
 811 3D Red Diawl Bach 10, 12 G1	 TG103 Stealth Green Holo 12 G1	 TG104 Stealth Black 10, 12 G1	 2804 DB Black Red Holo 10, 12 G1	 2805 DB Black Green Holo 10, 12 G1	 2806 DB Olive Green Holo 10, 12 G1		

T = Tactical Range - Specialist barbless flies

NYMPHS BUZZERS

G1 £1.35

G2 £1.65



















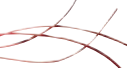

 2916 BL Buzzer Black Traffic Light 10, 12 G2	 2917 BL Buzzer Olive Traffic Light 12 G2	 2310 Apps Bloodworm Red 10 G1	 2421 Superglue Black Buzzer 10, 12, 14 G1	 2422 Superglue Olive Buzzer 10, 12, 14 G1	 2457 Bead Head Micro Midge Black Buzzer 16 G2
 2985 Rob's UV Buzzer 10 G1	 2766 BL Buzzer Depth Finder 10, 12 G2	 2471 3D Glass Blood Buzzer 10, 12 G1	 2472 3D Glass Dark Olive Buzzer 10, 12 G1	 2473 3D Glass Gold Olive Buzzer 10, 12 G1	 2474 Bibio Buzzer 10, 12 G1
 338 Black Adult Buzzer 12 G1	 1050 Nugget Buzzer Black Red 12 G2	 301 Bloodworm 12 G1	 332 Buzzer Black 10, 12 G1	 355 Chew Black Buzzer 12 G1	 436 Blakeston Black Buzzer 10, 12 G1
 2468 Oily Worm Buzzer 10 G1	 2470 3D Glass Black Buzzer 10, 12, 14 G1	 986 Flexi Floss Black Buzzer 10, 12 G1	 989 Crank Shank Black 12 G1	 994 SH Quill Buzzer Olive 12 G1	 995 SH Quill Buzzer Black 12 G1
 2475 Okey Dokey Buzzer 10, 12 G1	 2569 Traffic Light Buzzer 10, 12 G1	 BM100 BM Buzzer Claret 10, 12 G1	 BM101 BM Buzzer Black/Yellow 10, 12 G1	 BM102 BM Buzzer Black 10, 12 G1	 BM103 BM Buzzer Black/Silver 10, 12 G1
 983 Rutland Black Buzzer 10 G1	 984 Rutland Olive Buzzer 10 G1	 996 Red Neck Black 10 G1	 997 Red Neck Olive 10 G1	 BM104 BM Buzzer Olive 10, 12 G1	 SD110 Bloodworm 12 G1

NYMPHS GENERAL PURPOSE

G1 £1.35

G2 £1.65

G3 £2.10

 2912 BL Blue Flash Damsel GN 10 G3	 2044 BL Killer 10,12 G2	 9675 Chewing Gum Worm Cheese 10 G2	 9676 Chewing Gum Worm Zest 10 G2	 9677 Chewing Gum Worm Red 10 G2	 2802 RS Nemo Black 10, 12 G1
 165 Killer 10, 12 G1	 2914 BL Hot Head Straggle 10 G2	 1670 GRHE Nymph 10, 12, 14, 16 G1	 1730 GRHE Black Weighted 10, 12, 14 G1	 1733 GRHE Olive Weighted 12, 14, 16 G1	 1712 GRHE Nymph Weighted 10, 12, 14, 16, 18 G1
 2919 BL Okey Dokey 10 G2	 163 Lime 10, 12 G1	 166 Nemo Holo Red 10, 12 G1	 1708 Black Nymph Weighted 12 G1	 400 Atomic Worm 10 G1	 2308 Northern Spider Red 8 G1
 2807 Cruncher Olive Traffic Light 10, 12 G1	 2808 Cruncher Orange Traffic Light 10, 12 G1	 2491 Holo Hare Gold 12 G1	 PC111 WAEF - When All Else Fails 12 G1	 343 Hatching Olive 12 G1	 1665 Flashback Hare's Ear Weighted 10, 12, 14 G1
 PC110 Alley Cat 10 G1	 2172 May Taddy 10 G2	 2411 Bloodworm 10, 12 G2	 189 Crackton Nymph 12 G1	 2442 Hare's Ear Red Head 10, 12 G1	 2446 Copper Nymph 14, 16, 18 G1
 2615 Crazy Apps Red 10 G1	 9369 Wiggly Worm 12 G3	 9860 Mayfly Nymph 10 G3	 CJ112 CJ Holy Grail Hare's Ear Black 12, 14 G2	 CJ155 CJ Brite Head Hare 12 G2	
 CJ160 CJ Evening Hare's Ear 12 G1	 1881 BWO Flymph 14 G2	 9859 OE DB Beatis 16 G3	 8490 BL KJ Gangly Cruncher Black 10, 12 G2	 8491 BL KJ Gangly Cruncher Natural 10, 12 G2	 8473 BL Croston's Chenille Worm Red 14 G3

T = Tactical Range - Specialist barbless flies

FLIES NYMPHS

NYMPHS SHRIMPS, CORIXA & BUGS						G1 £1.35	G2 £1.65	G3 £2.10
 8106 BL Croston's Car Wash Tan 16 G3	 8107 BL Croston's Car Wash Caddis Green G3	 2301 Shrimp Pink 12 G1	 2714 O/E Heptagenid Nymph 12, 14 G3	 2720 O/E Freshwater Shrimp Wtd 14, 16 G2	 2719 Dirty Pink Shrimp 14, 16 G2			
 8108 BL Croston's Cased Caddis Jig Black 12 G3	 2290 Killer Shrimp 10 G1	 2428 Air Bubble Corixa 12 G1	 410 Sawyer Killer Bug 12, 14 G1	 SD169 Tan Spot On 12 G1	 425 Olive Weighted 12, 14 G1			
 2297 Micro Shrimp Pink 14 G1	 2298 Micro Shrimp Watery Pink 14 G1	 2315 Maggot 8 G1	 2713 O/E Baetis Nymph 14, 16 G3	 2716 O.E. Small Black Stonefly 12, 14 G3	 2880 Rubber Grub 12 G3			
NYMPHS STALKING BUGS						G2 £1.65		
 2051 Firebird 8 G2	 1028 Lead Bug Olive 12 G2	 1031 Lead Bug Black/Orange 12 G2	 1034 Lead Bug Chartreuse/White 12 G2	 1022 Lead Bug Black 12 G2	 1026 Lead Bug Red 12 G2			
NYMPHS PERDIGONS AND JIGS						G3 £2.10		
 8565 Croston's Micro Perdigon Black Widow S22 G3 NEW	 8476 BL Croston's Dark Olive Quill Jig Size 14, 16 G3 NEW	 8477 BL Croston's Light Olive Quill Jig Size 14, 16 G3 NEW	 8478 BL Croston's Natural Quill Jig Size 14, 16 G3 NEW	 2110 BL French Nymph Jig Size 14, 16 G3 NEW	 8333 BL Copper Top Duracell Size 14, 16 G3 NEW			
 8103 BL Croston's Perdi Bomb 18 G3	 9749 BL SR Spanish Bullet Olive 14, 16 G3	 9935 BL Perdigon Firestarter 14, 16 G3	 9929 BL Perdigon Firestarter Jig 14, 16 G3	 9930 BL Perdigon Caramel Jig 14, 16 G3	 9931 BL Perdigon Pearl & Orange Jig 14, 16 G3			
 9928 BL Perdigon HP Purple Jig 14 G3	 9927 BL Perdigon HP Red Jig 14 G3	 9748 BL SR Spanish Bullet French Nymph 14 G3	 9932 BL Perdigon Olive Hot Spot Jig 14 G3	 9955 BL Roza's Black Perdigon 16 G3	 9954 BL Roza's Pink French Fly 16 G3			
 2710 BL Pink Tag Jig 12, 14 G3	 9963 BL Roza's Pink Hare's Ear Jig 14, 16 G3	 2102 BL Pink Hot Spot 12, 14 G3	 2972 BBL KJ Flashback Red Tag 12, 14 G3	 8130 BL Roza's Coloured Water Fly 14 G3	 8334 BL Hot Rib Duracell 14, 16 G3			
NYMPHS CZECH						G2 £1.65		
 835 Superweighted Hears Ear Red 12 G2	 834 Super Weighted Hare's Ear & Cream 12 G2	 837 Czech Mate Pink 12 G2	 SM100 SM Czech Nymph Olive 10 12 G2	 831 Super Weighted Amber & Orange 12 G2	 833 Super Weighted Hare's Ear & Amber 12 G2			
NYMPHS DEPTH CHARGE WITH TUNGSTEN BEADS						G3 £2.10		
 2709 BL Natural Pheasant Tail Jig 12, 14 G3	 8134 BL Roza's Hare's Ear Bomb 14 G3	 8136 BL Roza's French Bomb 14 G3	 9695 BL MOP Fly Beige 14 G3	 9694 BL MOP Fly Chartreuse 14 G3	 2711 BL Peeping Caddis Jig 12 G3			
 8118 Ronan's Clarel Tungsten Nymph 14 G3	 8119 Ronan's Brown Tungsten Nymph 14 G3	 2708 Orange Hot Spot P/Tail Jig 12, 14, 16 G3	 1178 Pheasant Tail 12, 14, 16 G3	 1181 Grayling Bomb Pink 8, 10 G3	 2703 Red Neck Pheasant Tail 14, 16 G3			
 8120 Ronan's Hotspot Tungsten Nymph 12 G3	 1183 Shrimp Pink 10 G3	 2707 Tup Wool Bug 14, 16 G3	 2755 SR Pink Head Mary 14, 16 G3	 1098 Flash Back PT 12, 14 G3	 826 Hare's Ear Black 10, 12, 14 G3			
 CJ180 Czech Weapon 12, 14 G3	 2705 Copper Hare's Ear 14, 16 G3	 827 Hare's Ear Olive 12, 14 G3	 828 Natural Hare's Ear 10, 12, 14 G3	 2754 SR Orange Head Mary 14, 16, 18 G3	 2711 Peeping Caddis Jig 12, 14, 16 G3			

T = Tactical Range - Specialist barbless flies

NYMPHS GOLD BEADED

G2 £1.65

G3 £2.10

 2878 Duracell Jig 14, 16 G3	 2712 Micro Beadhead Pheasant Tail 20 G2	 1621 GRHE Natural Nugget 10, 12, 14 G2	 1620 GRHE Black Nugget 10, 12, 14 G2	 1656 Creeper Black Nugget 10 G2	 1647 Creeper Olive Nugget 10 G2
 2971 KJ CdC Red Tag 14, 16 G3	 2877 Flashback PTN 14 G3	 1622 GRHE Olive Nugget 10, 12, 14 G2	 1623 Mayfly Brown 12 G2	 1893 Copper John 14, 16 G2	 1895 Copper John Olive 14, 16 G2
 2970 KJ March Brown Jig 12, 14 G2	 2749 Micro Rambo 20 G2	 1682 Stonefly Nugget 10 G2	 2756 SR Skinny Quill Nymph Olive 16 G2	 2915 BL Hare's Ear Natural GN 10, 12 G3	 2449 Red Neck 14 G2
 1897 Flash Back Pheasant Tail 12, 14, 16 G2	 2750 Micro Beadhead Hare's Ear 20 G2	 2318 Bead Head Flexi Bloodworm 12 G2	 2447 Micro Mayfly 12, 14 G2	 391 Hare's Ear Olive Nugget 10, 12, 14, 16 G2	 395 Pheasant Tail Buzzer 12 G2
 2450 Grayling Pink 12, 14 G2	 2550 H/Head Hare's Ear Orange 12, 14 G2	 389 Hare's Ear Nugget 10, 12, 14, 16 G2	 390 Pheasant Tail Pupa 10, 12, 14, 16 G2	 484 Mayfly Nymph 10, 12 G2	 486 Shrimp Orange 12 G2
 396 Prince 10, 12 G2	 441 Stickfly Green 12 G2	 449 Bloodworm 12 G2	 467 Orange Tag 12 G2	 VK111 HVK Leadhead Hare's Ear 10 G2	 2443 Grayling Special Nymph 14 G2
 487 Stonefly Creeper Nugget 10 G2	 CJ110 Holy Grail Natural 12, 14 G2	 SM102 SM Copper Head 14 G3	 TG110 Blackhead Hare's Ear 12, 14 G2	 2876 Biot Nymph 14 G3	 1659 Creeper Peacock Nugget 10 G2

STILL WATER BUNG BUGS

G3 £2.10

 8452 Croston's Tungsten Mini Egg Pink 14 G3	 8453 Croston's Tungsten Mini Egg SunB 14 G3	 8457 Croston's Mini Cocktail Worm Hot 14 G3	 8458 Croston's Mini Cocktail Worm Coral 14 G3	 8460 Croston's Bung Buzzer Black 14/2.5mm G3	 8462 Croston's Bung Buzzer Wildcard 14/2.5mm G3
 8461 Croston's Bung Buzzer Olive 14/2.5mm G3	 8463 Croston's Bung Buzzer Viva 14/2.5mm G3	 8464 Croston's Bung Buzzer Black 14/3.0mm G3	 8466 Croston's Bung Buzzer Wildcard 14/3.0mm G3	 23A0086 Croston's Drop Back Bung M, L G3	

NYMPHS BLOBS, FABs & BOOBIES

G1 £1.35





























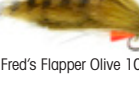













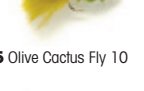









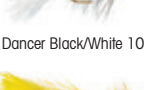





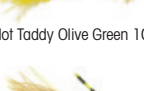



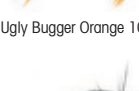





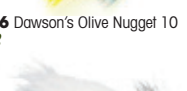
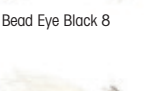

G2 £1.65

G3 £2.10

 8435 BL Croston's Mini Egg Fab Candy Size 14 G3	 8436 BL Croston's Mini Egg Fab Orange Size 14 G3	 8437 BL Croston's Mini Egg Fab Tequila Size 14 G3	 8442 BL Croston's Mini Egg Foobie Atomic S14 G3	 8443 BL Croston's Mini Egg Foobie Candy S14 G3	 8532BL Jenkins' Blue Flash Damselfly Booby S10 G2
 1885 G Nugget Blob Black 10 G2	 1886 G Nugget Blob Orange 10 G2	 2091 FAB Cocktail Orange Blob 10 G1	 2088 FAB Sunburst Blob 10 G1	 9891 FAB Ham & Cheese 10 G1	 2090 FAB Coral Spot 10 G1
 2163 Blob Cocktail Coral 10 G1	 2164 Blob Cocktail Orange 10 G1	 2144 Blob Cocktail With Wings 10 G1	 2165 Blob Cocktail Sunburst 10 G1	 2145 Blob Coral Spot 10 G1	 2148 Blob Twinkle Orange 10 G1
 2372 Crystal Bristol Viva Booby 10 G2	 2374 Crystal Bristol Cat Booby 10 G2	 2380 Booby Cormorant 10 G2	 2399 Cocktail Orange 10 G2	 2982 KJ Fenton Cat Booby 10 G2	 9785 Mini Booby Snake Black & Green 5cm G3
 2431 Woolfa 10 G2	 2433 Cat Straggles 10 G2	 2439 Cormorant 3D Red 10 G2	 330 Booby Cat's Whisker 10 G2	 342 Booby Black 10 G2	 349 Booby Orange 10 G2

T = Tactical Range - Specialist barbless flies

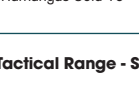
FLIES LURES

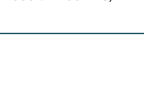
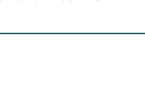
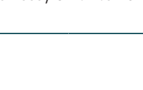
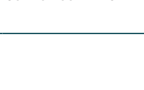
LURES		G1 £1.35	G2 £1.65	G3 £2.10	
 2253 Flexi Hot Head Black 10 G3	 2079 Creeper Cat 10 G2	 1041 Cormorant Traffic Light 10 G1	 1043 Stealth Cormorant Red Halo 10 G1	 2070 Cormorant UV 10 G1	 2071 Cormorant Hot Spot Red UV 10 G1
 2254 Flexi Hot Head Cat 10 G3	 2078 Creeper Olive 10 G2	 418 Classic FM Olive Weighted 10 G1	 1114 Cat's Whisker 10 G1	 1116 Floating Fry 10 G1	 1146 Stealth Cormorant Mirage 10 G1
 2255 Flexi Hot Head Damsel 10 G3	 2426 Bunney Hare's Ear 10 G1	 1145 Cormorant 10 G1	 2908 BL Yellow Dancer 10 G3	 1629 Cuf Throat Cat 10 G1	 2067 Cat Straggle 10 G1
 2861 Fred's Flapper Olive 10 G3	 2994 Blobby Worm Orange 10 G2	 1198 Cat Straggle Black 10 G1	 2068 Viva Straggle 10 G1	 8429 BL Mick Reid Taddy 08 G2	 2697 BL Viva Special 10 G2
 1770 Bung Foam Orange 10 G3	 1769 Bung Aero Orange 10 G3	 1179 Nomad Dawsons Olive 10 G2	 1604 Black/Green Nugget Woolly Bugger 10, 12 G2	 1605 White/Green Nugget Woolly Bugger 10 G2	 1606 Black Nugget Woolly Bugger 8, 10 G2
 2045 Kingfisher Blue Damsel 10, 12 G2	 1669 Orange Hot Head Damsel 10 G2	 1614 Black Cactus Fly 10 G2	 1615 Olive Cactus Fly 10 G2	 1616 Classic FM Orange Nugget 10, 12 G2	 1617 Classic FM White Nugget 10, 12 G2
 1173 Nomad Cat's Whisker 10 G2	 1608 Olive/Green Nugget Woolly Bugger 10, 12 G2	 1646 Nugget Viva 10 G2	 1649 Cat's Whisker Nugget 10, 12 G2	 1963 Ugly Bugger Black 10 G2	 1965 Ugly Bugger Olive 10 G2
 1607 Olive Nugget Woolly Bugger 10, 12 G2	 1645 Classic FM Olive Nugget 10, 12 G2	 2060 Dancer Black/White 10 G2	 2061 Dancer Blue 10 G2	 2062 Dancer Olive 10 G2	 2065 Dancer Viva 10 G2
 1644 Classic FM Black Nugget 10, 12 G2	 2059 Yellow Dancer 10 G2	 932 Hot Taddy Olive Green 10 G2	 934 Hot Taddy Viva 10 G2	 943 Viva Marabou Nugget 10 G2	 944 Montana Cat's Whisker Nugget 10 G2
 1966 Ugly Bugger Orange 10 G2	 790 Troutmaster 10 G1	 2255 Flex Hot Head Damsel 10 G3	 970 Montana Marabou Green Nugget 10, 12 G2	 971 Montana Marabou Orange Nugget 10, 12 G2	 9372 Woolly Bugger Black Skullhead 6 G3
 480 Montana Green 10, 12 G2	 956 Dawson's Olive Nugget 10 G2	 9964 Bead Eye Black 8 G2	 PC105 Tadpole Pete's Montana 10 G2	 TG130 Tadpole Terry's Orange 10 G2	 TG132 Terry's Damsel 10, 12 G2
 947 Leech Black Nugget 10 G2	 9951 Humungus Silver 10 G2	 9949 Martini Fry Hummie 10 G2	 9955 Humungus Sunburst 10 G2	 9956 Humungus White 10 G2	 9960 Humungus 10 G2
 9950 Humungus Gold 10 G2	 1165 Golden Bullet Cat's Whisker 10 G3	 1102 Nobbler Black 10, 12 G2	 1190 Bullet Black 10 G3	 936 Hot Taddy Olive Red 10 G2	 2906 Cat Nomad BL 10 G3

T = Tactical Range - Specialist barbless flies

LURES CARP & EGG PATTERNS

G1 £1.35
G2 £1.65

1772 Bionio Dog Biscuit Carp Fly 8 **G2**
1868 Breadcrust 8 **G2**
1869 Blobby Black 8 **G2**
1800 Close Copy Dog Biscuit 8 **G2**
1801 White Bread 8 **G2**
1919 Krystal Gold Hot Orange 10 **G2**
2156 Krystal Hot Orange 10 **G1**

LURES MUDDLERS, MINKIES, MINNOWS & FRY

G2 £1.65
G3 £2.10

2375 Minkie Booby White 10 **G2**
2376 Minkie Booby Silver 10 **G2**
1016 Muddler Black 8, 10 **G3**
1124 Mini Muddler Soldier 10 **G3**
1127 Mini Muddler 10 **G3**
977 Mylar Floating Roach 10 **G2**
1015 Muddler 4, 6, 8, 10 **G3**
3027 BL Flexi Olive Zonker 08 **G3**
1938 Mini Minkie Silver 10 **G2**
978 Mylar Floating Stickleback 10 **G2**
1969 Minkie Straggle 8 **G2**
1970 Minkie Black 8 **G2**
1928 Mini Minkie Black 10 **G2**
1937 Mini Minkie Brown 10 **G2**
2383 Minkie Suspender 8 **G2**
2570 Glass Minnow Brownie Par 10 **G2**
2571 Glass Minnow Rainbow Par 10 **G2**
2573 Glass Minnow Roach Fry 10 **G2**
1975 Minkie White 8 **G2**
1976 Minkie Pink 8 **G2**
2574 Polar Minnow Perch 6 **G2**
920 Floating Fry 10 **G2**
2990 Rob's Wrapped Minkie 8 **G3**
9544 Floating Perch Fry Special 4 **G2**

LURES SNAKES AND ZONKERS

G2 £1.65
G3 £2.10

8444 BL Croston's Wagon Warrior Viva 10 **G3**
8445 BL Croston's Wagon Warrior Cat 10 **G3**
8446 BL Croston's Waggon Warrior Damsel 10 **G3**
8417 BL Mini Weighted Snake Olive 5cm **G3**
8411 Snake Bait Natural 5cm **G3**
1980 Zonker Black Hot Tail 8, 10 **G2**
1982 Zonker White Hot Tail 8, 10 **G2**
1981 Zonker Olive Hot Tail 8, 10 **G2**
1958 Zonker Black 8, 10 **G2**
1959 Zonker Olive 8, 10 **G2**
2096 SR Black Tipped Olive Zonker 10 **G2**
9779 Mini Wld Snake Black 5cm **G3**
9778 Mini Wld Snake Cat 5cm **G3**
8375 Rob's Olive & Gold Snake 5cm **G3**
8376 Rob's Black & Gold Snake 5cm **G3**
9780 Mini Weighted Snake Olive 5cm **G3**
2266 BL Olive Snake 7cm **G3**
2264 BL Black Snake 7cm **G3**
2267 BL Pink Snake 7cm **G3**
2268 BL White Snake 7cm **G3**



LURES PREDATOR

G7 £4.95
G8 £5.95

9680 Whistler Red & White 4/0 **G8**
9681 Whistler Yellow & Orange 4/0 **G8**
2623 Yellow Perch 4/0 **G8**
2624 Baiffish Roach 4/0 **G8**
2625 Electric Yellow Roach 4/0 **G8**
2627 Clouser Roach 4/0 **G8**
9682 Whistler Articulated Red & White 4/0 **G8**
9580 Swim Frog Orange Belly 2 **G7**
2622 Baiffish Perch 4/0 **G8**
9922 Clydesdale Red Perch 1/0 **G8**
9925 Clydesdale Roach 1/0 **G8**
2618 Mouse Popper 2 **G7**
2526 Mouserat 6 **G7**
2649 UV Flashtail Whistler 6/0 **G8**
9570 Swim Bait Red Yellow 1/0 **G7**
2577 FM Fry Perch 4/0 **G8**
2493 Bunny Yellow 4/0 **G8**
2620 Sparkler Silver 6/0 **G8**
T = Tactical Range - Specialist barbless flies

FLIES SALTWATER

SALTWATER BASS								G4 £2.95	G6 £4.25	G7 £4.95	
											
9514 Softy Minnow Green 6 G7	9515 Softy Minnow Pearl 6 G7	9581 Sand Eel EeZee Blue 6 G4	9582 Sand Eel EeZee Chartreuse 6 G4	9585 Softy Sand Eel Blue & White 4 G6	9586 Softy Sand Eel White 4 G6	CO100 Sea Bass Blue 6 G4	CO101 Sea Bass Chartreuse 6 G4				
SALTWATER SURFACE PATTERNS									G8 £5.95		
											
2614 Skipping Bug White/Red 2/0 G8	2631 Mylar Popper Chart/White 2/0 G8	9499 Crease Fly Olive Back 4 G8	9333 NYAP 6/0 G8								
SALTWATER BIG FISH SPECIALS								G7 £4.95	G8 £5.95		
											
9775 Black & Purple Brushy 6/0 G8	9332 Mega Clouser 4/0 G7	9509 GT Fly Flash Profile 4/0, 6/0 G8	9527 GT Brushy Profile 6/0 G8								
SALTWATER CLOUSERS & DECEIVERS								G5 £3.40	G6 £4.25		
											
9601 Clouser Chartreuse/White 2/0, 2, 6 G5	9603 Clouser Black 2/0, 2, 6 G5	9602 Clouser Red/White 2/0, 2 G5	9600 Clouser Grey Ghost 2/0, 2, 6 G5	9327 FM Deceiver Chartreuse/White 2/0 G5	9997 Clouser Slinky 2/0, 2, 6 G5	8150 Daz's Sandeel Olive & White 2/0 G6	8152 Daz's Blue & White Deceiver 2/0 G6	8153 Daz's Bendback Chartreuse & White 2/0 G6	8154 Daz's Bendback Olive & White 2/0 G6	9989 Deceiver Blue/White 2/0 G5	9990 Deceiver Red/White 2/0 G5
SALTWATER BAITFISH PATTERNS									G6 £4.25		
											
9524 Los Roques Minnow Green 2, 6 G6	9561 Surf Candy Olive 1/0 G6	9562 Surf Candy Chartreuse 1/0 G6	9564 Baitfish Olive Epoxy 2 G6	9565 Baitfish Olive/White Epoxy 2 G6							
SALTWATER TARPON									G7 £4.95		
											
8035 Millhouse Tarpon Toad Chartreuse 1/0 G7	8037 Millhouse Tarpon Toad Black Death 1/0 G7	9297 Black Death 4/0, 2/0 G7	9323 Rabbit Roach 4/0 G7	9318 Tarpon Bunny Black Death 4/0 G7	9319 Tarpon Bunny Purple Death 4/0 G7						
SALTWATER BONEFISH								G4 £2.95	G6 £4.25		
											
9337 Pillow Talk 6, 8 G4	9725 Fuzzle Shrimp Olive 4 G4	9100 Gotcha 4, 6, 8 G4	9612 Clouser Non Tangle 2 G4	9178 Skinny Shrimp Tan 6 G4	9107 Crazy Charlie 4, 6 G4	9334 Sand Prawn 4, 6 G4	9111 Crazy Charlie Tan 4, 6 G4				
											
9728 Critter Bug Tan 6 G4	9188 Hot Legs Foxy Gotcha 6 G4	9113 Ultra Shrimp Pink 4 G4	9125 Stealth Gotcha 6, 8 G4	9151 Clouser Bone Chartreuse 6 G4	9152 Clouser Bone Pink 6 G4	9153 Clouser Bone Tan 6 G4	9986 Crazy Charlie Pink 6 G4				
											
8025 Vlahos Bahama Shrimp Tan 6 G4	8027 Vlahos Bahama Shrimp Olive 6 G4	9182 Cuban Shrimp Tan 4, 6 G4	9181 Cuban Shrimp Light Tan 4, 6 G4	9112 Ultra Shrimp Tan 4 G4	9727 Julia 2 G4	9540 Christmas Spec Orange 4, 6 G4	9541 Christmas Spec Pearl 4, 6 G4				
											
8123 Sydney's Shrimp Tan 6 G4	8124 Sydney's Shrimp Olive 6 G4	9190 Clouser Foxy Hot Legs 4, 6 G4	9185 Homer Shrimpton 2, 4 G4	CO105 Sand Shrimp 6 G4	9510 Bitter's Amber 6, 8 G4	9193 Bunny Bitters 06 G4	9726 Ichy Trigger 4 G6				
SALTWATER CRABS AND SHRIMPS								G4 £2.95	G6 £4.25		
											
9097 JT's Creole Crab Olive 4 G6	9095 JT's Creole Crab Tan 4 G6	9098 Grand Slam Crab Tan 4 G6	9101 Chernobyl Crab 4 G6	9102 Del's Merkin 4 G6	9094 Keel (Avalon) Shrimp 4 G4						

SEA TROUT SURFACE				G5 £3.40	G6 £4.25
					
9712 Steffan Jones Night Stalker 2 G6	1265 Black Magic Blue 6 G5	1264 Black Magic Yellow 6 G5	1400 Surface Lure 2 G5		
SEA TROUT SNAKE				G5 £3.40	G6 £4.25
					
2685 Alexandra 3" G5	2687 Blue Pearl 3" G5	1292 Black & Silver 2.5" G5	9348 Nightmare Silver Stoot 10, 12 G6		
SEA TROUT TANDEM				G5 £3.40	G6 £4.25
					
2681 Black & Red 6 G5	2682 Squirrel Blue & Silver 6 G5	1206 Secret Weapon 8 G5	9713 Steffan Jones MJ Towy Special 6 G6	9715 Steffan Jones BBS Slinger 4 G6	
SALMON & SEA TROUT SINGLES			G3 £2.10	G4 £2.95	G5 £3.40
					
1321 Stoot's Tail 8, 10 G4	1322 Stoot's Tail Silver 8, 10 G4	1307 Medicine Mallard 8 G4	1308 Medicine Teal 8, 10 G4	9708 Steffan Jones Daioni 08 G5	
					
1393 Bomber Brown 4, 6 G4	1394 Bomber Green 4, 6 G4	1368 JW Nymph Orange 6 G4	1491 JW Nymph Hare's Ear 6 G4	1365 JW Nymph Black 6 G4	
					
2785 Cascade Green Buff 8, 10 G4	2786 Willie Gunn Gold 8, 10 G4	9654 Silver Stoot 10, 12 G3	9710 Steffan Jones Mr Fish 8 G5	9656 Silver Doctor 10, 12 G3	
SALMON DOUBLES				G5 £3.40	G6 £4.25
					
1432 Green Highlander 8, 10 G5	1434 Ally's Cascade Shrimp 6, 8, 10, 12, 14 G5	1437 Ally's Shrimp Red 6, 8, 10 G5	1440 Ally's Shrimp 8, 10, 12, 14 G5	1478 Gledswood Stoot Piglet 8, 10 G5	
					
9361 Cascade Willie Gunn 08, 10 G6	1421 Stoot's Tail Silver 8, 10, 12, 14 G5	1426 Stoot's Tail Mirage 8, 10 G5	1470 Cascade Piglet 6, 8, 10 G5	1425 Willie Gunn 6, 8, 10, 12 G5	
					
1420 Stoot's Tail 8, 10, 12, 14 G5	1433 Executioner 6, 8, 10 G5	1458 Flamethrower 6, 8, 10 G5	1459 Flamethrower Red 6, 8, 10 G5	1490 Aurora Shrimp 8, 10 G5	
					
1443 Willie Gunn Gold 8, 10, 12, 14 G5	1448 Bann Special 8, 10 G5	1445 Red Frances 8, 10, 12, 14 G5	1446 Black Frances 8, 10, 12, 14 G5	1542 Posh Tosh 8, 10 G5	

FLIES SALMON/CONEHEADS

SALMON DOUBLES (CONTINUED)

G5 £3.40

G6 £4.25

9827 Stokoe's Shrimp Original 8, 10, 12
G6

9826 Stokoe's Shrimp Red 8, 10, 12
G6

2029 RS Low Water Cascade 12, 14
G6

2118 Feeler Willie Gunn 8, 10, 12
G6

2115 Feeler Cascade 8, 10, 12
G6

1463 Green Butt 8, 10
G5

1541 Flamethrower Willie Gun 8, 10
G5

2119 Green Butt Cascade 8, 10, 12
G6

9352 RS Squid Cascade 8, 10
G6

9350 RS Squid Hot Orange 8, 10
G6

SALMON MICRO DOUBLE

G6 £4.25

9644 Micro Green Butt Cascade 14
G6

9650 Micro Ally's Shrimp Red 14
G6

2774 Micro RS Low Water Silver Stoot 14
G6

9645 Micro Silver Stoot 14
G6

9652 Micro Mirage Stoot 14
G6

SALMON TREBLES

G5 £3.40

G6 £4.25

9637 Stoot's Tail 16, 18
G6

1530 Black Frances 10, 12, 14
G5

1533 Red Frances 10, 12, 14
G5

1569 Blue Charm 14, 16
G5

1571 Green Butt 14, 16
G5

1525 Ally's Cascade 8, 10
G5

9633 Sunray Shadow 16, 18
G6

9640 Cascade Micro 16, 18
G6

9641 Red Frances Micro 16, 18
G6

1573 Black & Yellow 16
G5

SALMON ZELDAS

G6 £4.25

9718 Zelda Black & Green 12, 14
G6

9720 Zelda Black & Red 12, 14
G6

9721 Zelda Orange & Green 12, 14
G6

SALMON SNAELDAS

G6 £4.25

2820 RS Super Snaelda Red & Gold ½", ¾"
G6

9340 RS Solar Super Snaelda ½", 1"
G6

9342 RS Solar Super Snaelda Flaming ½", 1"
G6

2214 Snaelda Cascade ½", ¾"
G6

2819 RS Super Snaelda WG ½", ¾"
G6

SALMON CONEHEAD TUBES

G5 £3.40

G6 £4.25

1250 Black Frances ½"
G6

1251 Red Frances ½"
G6

1347 Cascade Hot 1", 1½"
G5

2205 Cascade Helmsdale Feeler ¾"
G6

2208 Feeler UV Willie Gunn ¾"
G6

2201 Cascade Alistair UV ½"
G6

2817 RS Super Snaelda Black & Silver ½"
G6

2207 Flamethrower UV Feeler ¾"
G6

2202 Cascade Monkey ½", ¾", 1"
G6

2826 Red Frances Brass ½"
G6

1289 Cascade 1", 1½"
G5

1383 Sunray Shadow 1", 1½"
G5

2221 Tiger Tail Flamethrower ¾"
G5

1286 Flamethrower 1"
G5

2827 Black Frances Brass ½"
G6

1498 Posh Tosh 1", 1½"
G5

1382 Willie Gunn Gold 1", 1½"
G5

2203 Dee Monkey ½"
G6

2824 Monkey Conehaed ½"
G6

9777 Mini Sunray ¾"
G5



SALMON BRASS TUBES				G5 £3.40	G6 £4.25
					
2193 Helmsdale Alistair UV ½", 1" G6	1497 Posh Tosh 1" G5	2187 Cascade UV Alistair ½", 1" G6	1261 Cascade 1", 1½" G5		
					
2197 Tiger Tail Flamethrower 1" G6	2813 Red Snaelda 1" G5	1239 Ally's Shrimp ¾", 1" G5	1263 Red Frances ½", 1", 1½" G5	1260 Black Frances ½", 1", 1½" G5	
					
2194 Posh Willie Gunn ½" G6	1234 Willie Gunn 1", 1½" G5	1523 Willie Gunn Gold 1" G5	2829 Classic Black & Yellow 1" G6	2192 Willie Gunn UV Feeler 1" G6	

SALMON SKULLHEAD TUBES				G6 £4.25	
					
2842 Black & Yellow Skullhead ½", 1" G6	2837 Cascade SkullHead ½", 1" G6	2843 Dee Monkey SkullHead ½", 1" G6	2844 Scandi Monkey SkullHead ½", 1" G6		

SALMON BRASS BOTTLE TUBES				G5 £3.40	G6 £4.25
					
2186 Classic Dee Monkey ¾" G6	1335 Cascade Monkey ¾" G6	1340 Cascade Piglet ½" G5	1314 Gledswood Piglet ½" G5	2888 German Snaelda ½", 1" G6	

SALMON ALUMINIUM TUBES				G5 £3.40	G6 £4.25
					
1226 Willie Gunn ¾" G5	1227 Collie Dog 1" G5	2673 Squirrel Blue & Silver 1" G5	2674 Sewin Sloat 1" G5	2828 Classic Black & Yellow 1" G6	

SALMON NYLON & HITCH TUBES				G4 £2.95	G5 £3.40
					
9776 Mini Hitch Sunray ¾", 1" G4	1370 Sunray Shadow Hitch 1½" G4	1371 Silver Stoot's Tail Hitch ¾" G4	1373 Cascade Hitch ¾" G4		
					
1208 Collie Dog 1" G4	2235 Tsunami Rubber Legs ½", 1" G5	2229 Monkey Cascade ¾" G5	2233 Micro TD Silver Stoot ¼" G5		

SALMON LAERDAL SUNRAY SHADOWS - NYLON TUBES			G5 £3.40
			
2857 Laerdal Sunray Orange 1½" G5	2858 Laerdal Sunray Yellow 1", 1½" G5	2859 Laerdal Sunray Blue 1", 1½" G5	

FLIES MIKAEL FRÖDIN SALMON

CLASSIC SERIES

All £8.99

Mikael Frödin's most successful patterns all have their origins within this family. These classic flies are tied with collar hackles in front of the wing and a 1/2 turbo cone to create turbulence, translucency and a broad profile. Different cones give different shapes and profiles. The regular cone for the slimmest fly and turbo cones for the fattest flies with the broadest profile. These flies will work in a wide variety of conditions, depths and speeds.



FF-CSBS Black and Silver
Size 6cm, 8cm



FF-CSIFL In Flames
Size 6cm, 8cm



FF-CSMB Mikkeli Blue
Size 6cm, 8cm



FF-CSWG Willie Gun
Size 6cm, 8cm



FF-CSPK Pahtakorva
Size 6cm, 8cm



FF-CSSL Sillen
Size 6cm, 8cm



FF-CSTW The Witch
Size 6cm, 8cm



FF-CSMS Moonshine
Size 6cm, 8cm

SAMURAI SERIES

All £8.99

A super modern sunray type pattern with an elongated teardrop shape. Tied with a small turbo cone and a long straight wing. Samurais seem to work when nothing else does – fish them as fast as you dare and hold onto your rod!



FF-SSAL Ally Samurai
Size 4cm, 8cm, 12cm



FF-SSZB Zebra Samurai
Size 4cm, 8cm, 12cm



FF-SSSL Silver Samurai
Size 4cm, 8cm, 12cm



FF-SSGR Green Samurai
Size 4cm, 8cm, 12cm

MICRO SERIES

All £7.99

These micro classics are perfect for when a little more subtlety is needed. Note the class teardrop shape, "no-body" construction, super soft materials and the micro turbo cone. Fish these micro catchers either up near the surface or down deep.



FF-MSDS Dee Sheep Micro
Size 1.5cm, 3cm



FF-MSPK Pahtakorva Micro
Size 1.5cm, 3cm



FF-MSWG Willie Gun Micro
Size 1.5cm, 3cm



FF-MSGL Greenlander Micro
Size 1.5cm, 3cm

TTT NOBODY SERIES

All £8.99

These small weighted tubes with the new Tungsten Turbo Tube and soft hackles will out swim everything. The small turbo cone with the soft mini marabou hackles and the tapered wing creates a fly that looks like it will bite the leader and swim off by itself.



FF-TSNB Nasty Banana TTT
Size 3cm, 6cm



FF-TSIFL In Flames TTT
Size 3cm, 6cm



FF-TSWG Willie Gun
Size 3cm, 6cm



FF-TSPK Pahtakorva
Size 3cm, 6cm

HITCH SERIES

All £5.99

BOMBER SERIES

All £8.99

Hitch Flies

Fish these with a micro hitch to create a small "V" on, in or just under the surface.



FF-HFBS Black Simple Hitch
Size 1.5cm, 3cm



FF-HFGL Greenlander Hitch
Size 1.5cm, 3cm

Tri Turbo Bomber

A high skating bomber with a reversed rubber turbo cone. Watch out for explosive surface takes.



FF-TBBR Brown TT Bomber
Size 2cm, 4cm



FF-TBGR Green TT Bomber
Size 2cm, 4cm

FRODIN FLY SELECTIONS



8 Great Flies for Flooded Conditions

Coloured flies with a large silhouette! A set of 8 flies that shine and are seen in dirty conditions, presented in a Frodin double box.

Code **FF-8GF-1FC** £69.99



8 Great Flies for Tea Coloured Water

Frodin's favourites for the darker water. A set of 8 flies that have caught thousands of salmon, presented in a Frodin double box.

Code **FF-8GF-3HT** £69.99



8 Great Flies for Sunny Days

A set of 8 of Frodin's favourite flies for spooky fish and bright days - tricky but not impossible - presented in a Frodin double box.

Code **FF-8GF-5SD** £59.99

Other Frodin fly selections are available please visit www.sportfish.co.uk or call 01544 327111 for more information.

FULLINGMILL  **MUST HAVES...**
RAISING THE GAME



Wets 12 Flies
Perfect for wet fly fishing for wild brown trout.
Code 155010 £13.50



Nymphs 11 Flies
Effective for stocked and resident fish at any stillwater. Also works well for river trout.
Code 155015 £13.50



Dries 8 Flies
Perfect for targeting rising fish on both rivers and stillwaters.
Code 155020 £13.50



Hare's Ears 11 Flies
Ideal for those looking to fish any stillwater.
Code 155025 £13.50



Buzzers 11 Flies
Perfect for those looking to fish buzzers for the first time or filling a few gaps.
Code 155040 £13.50



Diawl Bachs 12 Flies
Perfect for those looking to try nymph fishing for the first time or filling a few gaps.
Code 155045 £13.50



Adams 8 Flies
Perfect for those looking to fish dry flies on both rivers and lakes.
Code 155050 £13.50



Klinkhammers 8 Flies
Perfect for those looking to fish dry flies on both rivers and lakes.
Code 155060 £13.50



Golden Nuggets 9 Flies
Ideal for those looking to fish stillwaters and reservoirs at any time of the year.
Code 155080 £13.50



Czech Mates 10 Flies
For those looking to try Czech nymphing for the first time.
Code 155085 £13.50



Mayflies 8 Flies
Perfect for targeting summertime trout feeding on mayflies at any stage of the hatch.
Code 155030 £13.50



Boobies 9 Flies
Best fished on a sinking line, retrieved quickly if the fish are aggressive, or slowly if the trout are pressured.
Code 155065 £13.50

Daddies 8 Flies
Fished wet or dry, these are ideal for targeting trout feeding on daddies.
Code 155055 £13.50



Damsel Nymphs 10 Flies
Perfect for targeting feeding trout on small stillwaters and reservoirs.
Code 155035 £13.50



Blobs 11 Flies
Fish these flies for stocked rainbow and brown trout on anything from a floater to a very fast sinker.
Code 155070 £13.50



Crunchers 12 Flies
Perfect for straight line nymphing. Especially effective when the fish are feeding naturally
Code 155075 £13.50



PREMIUM FLY SELECTIONS

Premium Bonefish Selection 12 Flies
Code 165010 £32.35



Premium Sea Bass Selection 8 Flies
Code 165015 £32.35



Premium Low Water Salmon Selection 10 Flies
Code 165020 £32.35



Premium High Water Salmon Selection 11 Flies
Code 165025 £32.35



Premium Chalk Stream Selection 20 Flies
Code 165030 £32.35





Lake Selection 1 6 Flies
This lake selection features lure patterns chosen by some of the best anglers in the UK.
Code 145010 £7.25



Lake Selection 2 6 Flies
This lake selection features nymph and buzzer patterns chosen by some of the best anglers in the UK.
Code 145015 £7.25



Stillwater Dries 6 Flies
Features patterns that will cover a wide range of hatching insects, perfect for targeting rising fish.
Code 145020 £7.25



Klink N' Dink Selection 5 Flies
Tried and tested nymph and dry patterns that are perfect for fishing the Klink n' Dink technique.
Code 145025 £7.25



Puddle Bung Selection 5 Flies
Features a range of patterns suited to fishing the 'bung', an extremely effective method on small stillwaters.
Code 145030 £7.25



River Dries Selection 5 Flies
This selection covers a range of hatching insects, perfect for targeting rising fish in rivers
Code 145035 £7.25



Damsel Nymphs 7 Flies
Imitative damsel patterns that will always catch fish all year round.
Code 12A0305 £9.49



Buzzers 7 Flies
Always work everywhere. Fish these as slow as you can. A small fly that catches big trout.
Code 12A0308 £9.49



Dry Flies 6 Flies
If you want to catch trout off the top this useful selection is perfect at any time of year.
Code 12A0301 £9.49



Classic Wet Flies 8 Flies
These classic flies will catch trout anywhere when fished below the surface.
Code 12A0303 £9.49



Allround Still-Water Flies 7 Flies
A perfect selection of flies for any day on a stillwater. All proven fish catchers.
Code 12A0304 £9.49



Still-Water Lures 6 Flies
These lures will catch trout in any stillwater when fished on a floating or sinking line.
Code 12A0306 £9.49

BUILD YOUR OWN C&F FLY BOX



C&F DESIGN

1.

Choose your empty waterproof box from the range of 3 sizes and 5 colours...

SMALL

Universal Waterproof Case
Size: 130 x 100 x 40mm



Empty
Code 23A0040 £16.99

Colours: Off White, Black, Olive, Orange, Sky Blue

MEDIUM

Universal Waterproof Case
Size: 155 x 105 x 40mm



Empty
Code 23A0040 £23.99

Colours: Off White, Black, Olive, Orange, Sky Blue

LARGE

Universal Waterproof Case
Size: 197 x 114 x 42mm



Empty
Code 23A0040 £25.99

Colours: Off White, Black, Olive, Orange, Sky Blue



Empty one side plus 9 compartments
Code 23A0040 £28.99

Colours: Off White, Olive



Empty one side plus 12 compartments
Code 23A0040 £34.99

Colours: Off White, Olive



Empty one side plus 12 compartments
Code 23A0040 £33.99

Colours: Off White, Olive

2.

Fit your box from a choice of 9 individual interchangeable internal options...

Universal System Streamer

Small: £7.99
Medium: £7.99
Large: £9.99
Code 23A0039

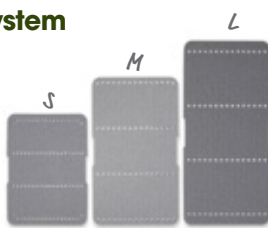

Universal System Midge

Small: £7.99
Medium: £7.99
Large: £9.99
Code 23A0039

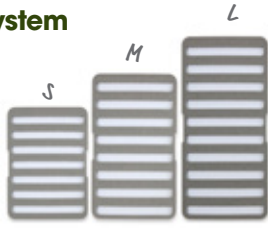

Universal System Tarpon

Small: £7.99
Medium: £7.99
Large: £9.99
Code 23A0039

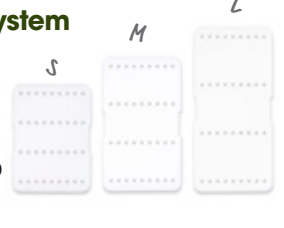

Universal System Attractor

Small: £7.99
Medium: £7.99
Large: £9.99
Code 23A0039

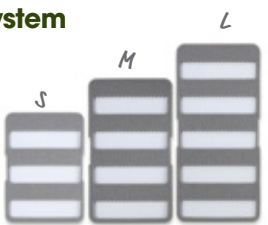

Universal System Dry Dropper

Small: £9.99
Medium: £9.99
Large: £14.99
Code 23A0039

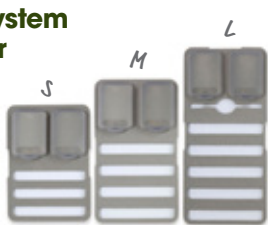

Universal System Permit

Small: £7.99
Medium: £7.99
Large: £9.99
Code 23A0039



Universal System Standard

Small: £7.99
Medium: £7.99
Large: £9.99
Code 23A0039

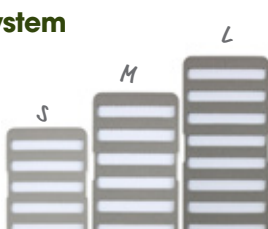

Universal System Threader

Small: £21.49
Medium: £24.99
Large: £28.49
Code 23A0039

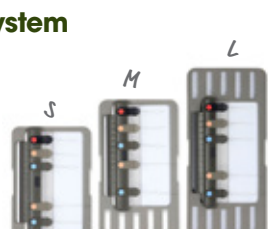

Universal System Bonefish

Small: £7.99
Medium: £7.99
Large: £9.99
Code 23A0039

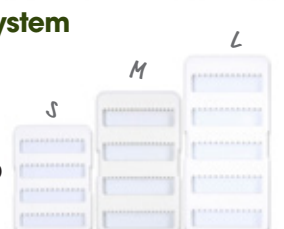

C&F REGULAR FLY BOXES

SMALL

Regular Waterproof Box
Size: 130 x 100 x 40mm



Small Regular Attractor
Code 23A0041 £32.99



Small Regular Standard
Code 23A0041 £32.99



Small Regular Midge
Code 23A0041 £32.99

MEDIUM

Regular Waterproof Box
Size: 155 x 105 x 40mm



Medium Regular Attractor
Code 23A0041 £39.99



Medium Regular Standard
Code 23A0041 £39.99



Medium Regular Midge
Code 23A0041 £39.99

LARGE

Regular Waterproof Box
Size: 197 x 114 x 42mm



Large Regular Attractor
Code 23A0041 £45.99



Large Regular Standard
Code 23A0041 £45.99



Large Regular Midge
Code 23A0041 £45.99

C&F DESIGN

LARGE

Regular Waterproof Saltwater Box
Size: 197 x 114 x 42mm



Large Regular Saltwater Tarpon
Code 23A0041 £45.99



Large Regular Saltwater Permit
Code 23A0041 £45.99



Large Regular Saltwater Bonfish
Code 23A0041 £45.99

PLAN D FLY BOXES

Plan D Fly boxes are built with high quality components and a water-resistant seal. They are incredibly durable and will keep your flies and tube flies secure and dry in the harshest of environments.

Two sizes available:

Pocket (16.7 x 13.3 x 3.6cm) or
Pack (24.2 x 13.3 x 4.1cm)

Three interior options available:

Max Standard, Max Tube or Tube

Six options available Code 18A0112

A Pocket Max Standard £32.99

Two sides, base and lid, of slotted foam for standard flies

B Pack Max Standard £36.99

Two sides, base and lid, of slotted foam for standard flies

C Pocket Max Tube £59.99

Two sides of tube fly mandrel holders. Each side holds up to 20 tube flies and each Max box up to 40 tube flies. Includes two medium mandrel kits.

D Pack Max Tube £59.99

Two sides of tube fly mandrel holders. Each side holds up to 20 tube flies and each Max up to 40 tube flies. Includes two medium mandrel kits.

E Pocket Tube £44.99

One side of tube fly mandrel holders with a clear lid. Holds up to 20 tube flies. Includes one medium mandrel kit.

F Pack Tube £49.99

One side of tube fly mandrel holders with a clear lid. Holds up to 20 tube flies. Includes one medium mandrel kit.

Pack of 20 Spare Mandrels

Sizes: Small or Medium Code 18A0113 £4.99





Turrall English Classic Trout Fly Selection - 48 Flies

A comprehensive collection of the most famous English trout flies presented in a hand-crafted bamboo fly box. Many of the patterns date back to the 1800's and include flies tied originally by legends such as Sawyer, Lunn, Wickham, Greenwell, Hardy and Walker. 48 flies

Code 19A0117 £64.99



Turrall Presentation Selections

A series of fly selections presented in a mellow split cane fly box. Each one offers a balanced choice of essential flies.

Options:

A Dry Flies (32)

B Spring Hatch Match (32)

C Stillwater Essentials (32)

Code 11A0344 £59.99



Polished aluminium

Wheatley Laser Engraved Leaping Trout

A classic 6" polished aluminium Wheatley box with a modern laser engraved image of a leaping trout on the front. Ripple foam on one side and flat foam on the other.

Code 18A0090

Ref No.	Description	Size	Price
1603 BT	Brown Trout	15 x 9 x 3cm	£79.99



Wheatley Compartment Boxes

The 'Rolls Royce' of dry fly boxes. Each compartment has a separate spring-loaded window.

Code 11401

Ref No.	Description	Size	Price
1407F	12 compartments, foam in lid	12 x 9 x 3cm	£79.99
1607F	16 compartments, foam in lid	15 x 9 x 3cm	£89.99
1609	16 compartments in base & 16 in lid	15 x 9 x 4cm	£179.99



Wheatley Tube Fly Boxes

Excellent boxes that hold tube flies without damaging the delicate dressings.

Code 11403

Ref No.	Description	Size	Price
1605SP	Vertical tube slots & foam in base & lid	15 x 9 x 3cm	£84.99
1605	Horizontal tube slots & foam in base & lid	15 x 9 x 3cm	£84.99



4604R

4404R

Wheatley Foam Boxes Code 80182

Ref No.	Description	Size	Price
4404R	Black box. Ripple foam in base & lid	12 x 9 x 3cm	£69.99
4604R	Black box. Ripple foam in base & lid	15 x 9 x 3cm	£74.99



1602/1.5F



1601F

Wheatley Foam Boxes Code 11398

Ref No.	Description	Size	Price
1601F	Flat foam in base & lid	15 x 9 x 3cm	£74.99
1601/1.5F	Flat foam in base & lid	15 x 9 x 4cm	£79.99
1602/1.5F	Flat foam in base & lid. Swingleaf	15 x 9 x 4cm	£89.99



1601ES

Wheatley Easy Slot Boxes

'Easy-Slot' foam has been developed to hold delicate flies without crushing or bending the delicate hackles and dressings. Classic polished aluminium. Slimline version (1.5cm) also available.

Code 10210

Ref No.	Description	Size	Price
1601ES	Easy Slot Foam	15 x 9 x 3cm	£79.99
1601SLES	Easy Slot Foam	15 x 9 x 2cm	£79.99



Greys GS Fly Boxes

Made from strong and light ABS plastic with a swinging slot foam middle leaf. The large GS fly box is designed to hold large lure types flies, and the medium size box is small enough to fit easily in your fly vest.

A Medium (396 Flies) **Size:** 13 x 5 x 4cm **£11.99**

B Large (450 Flies) **Size:** 19 x 8 x 4cm **£16.99**

Code 11A0015



Greys GS Water Resistant Fly Box

The GS fly box from Greys is water resistant and has vertical slotted foam rows and will hold up to 237 flies.

Size: 20 x 11 x 5cm **Colour:** Black

Code 14A0162 £16.99

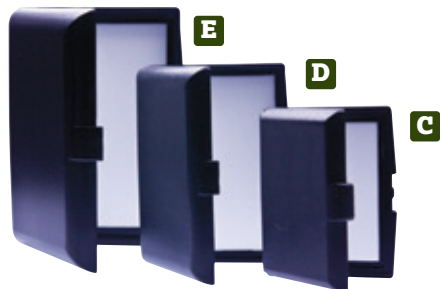

Pocket Fly Boxes

Light but very strong slim black moulded boxes with plastazote linings and metal hinge pins.

C Small **Size:** 8 x 10cm **£2.99**

D Medium **Size:** 9 x 13cm **£3.99**

E Large **Size:** 11 x 15cm **£5.49**

Code 11416

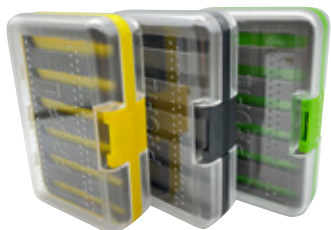

Leeda Profil Fly Boxes

This tough and durable fly box offers maximum visibility to anglers with quick access to their flies. Double-sided clear lids with unique fast access clips. Holds up to 250 flies securely in slotted foam.

Size: 14 x 9 x 4cm **Colours:** Black, Yellow or Green

Code 11A0282 £7.99



MFC Waterproof Boat Fly Box

A rugged waterproof plastic box for all your large flies when you are out on the water. Perfect for saltwater, all pike flies and even mayflies! An optional swing leaf can be added to double the capacity.

Size: 26 x 33 x 10cm

F Boat Box **£99.99** **G** Swing Leaf **£23.99**

Code 13A0132



Snowbee Slimline Fly Box Kit

Designed with the serious fly tyer or fly fisher in mind, this innovative kit consists of 5 slimline fly boxes, neatly stored in a zip-closed divider bag, taking up the minimum of space. The 5 slimline fly boxes will hold up to an amazing 1,170 flies in a carry bag.

Size: 20 x 12 x 8cm

Code 14A0159

Description	Price
Slimline Fly Box	£9.99
Divider Bag	£15.99
Slimline Fly Box Kit	£64.99



Orvis Ultralight Foam Fly Boxes

Ultralight, floating, fly boxes made of durable moulded foam with secure micro foam slits inside on both sides. Tenacious magnetic closure. Two sizes available and two colours.

Medium

Size: 13 x 8 x 3cm – 10 rows of slotted foam **£20.99**

Large

Size: 16 x 10 x 3cm – 12 rows of slotted foam **£23.99**

Colours: **H** Grey or **I** Citron

Code 18A0069



Wychwood VUEfinder Fly Boxes

A strong, lightweight, waterproof concept fly box with a clear lid. Available in two sizes. Available in 3 foam options - Double Ripple Foam (L only), Ripple and Slot Foam (S only), Double Slot (S and L).

J **Size:** S 13 x 8cm **£15.99**

K **Size:** L 15 x 9cm **£17.99**

Code 80308



Wychwood VUEfinder Competition Boxes

- Capable of storing up to 1,000 flies
- Durable, water resistant, clear lid concept fly box with a unique locking clip which includes an International Rules hook gauge
- 3 options available: Double Ripple Foam, Double Slot Foam and Ripple/Slot Foam

Size: 30 x 19cm

Code 90552

£34.99



Wychwood VUEfinder Dry Fly Box

Waterproof dry fly compartment box with clear sides so you can see your flies. Compartment/slots configuration.

Size: L 15 x 9cm

Code 11A0289

£18.99



MFC Trout Print Fly Box

A plastic slotted foam with a beautiful brown trout print.

Code 12A0292

£32.99

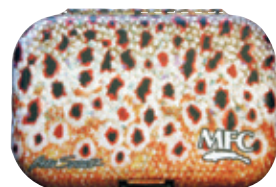



Myran Fly Boxes

Made of clear, hard unbreakable plastic, the internal dividers of these boxes touch the lid and ensure that items cannot move from one compartment to another. Myran boxes are the best quality and have been our best selling storage boxes for over 10 years. Swedish made.

Code 11421

Ref No.	Size	Sections	Price
1060	11 x 9 x 2cm	6	£5.99
1120	11 x 9 x 2cm	12	£5.99
1200	16 x 10 x 3cm	12	£6.99
2000	11 x 9 x 3cm	5	£5.99
6000	17 x 10 x 3cm	10	£6.99
7000	17 x 10 x 3cm	5	£6.99
8000	12 x 10 x 4cm	3	£6.99



Fulling Mill Xtreme Boxes

These waterproof and dustproof boxes feature a locking clip, a rubber seal and can be padlocked. Perfect for keeping your favourite flies and other valuables safe.

- A** Small **Size:** 23 x 18 x 5cm **£23.50**
 - B** Medium **Size:** 35 x 23 x 6cm **£35.75**
 - C** Large **Size:** 35 x 23 x 9cm **£38.95**
- Code 16A0005**

ETHAFOAM

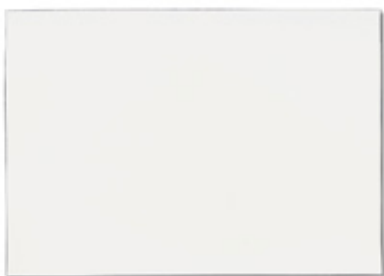

Ethafom

White, flat, 4mm ethafoam with a self-adhesive backing. Useful for relining fly boxes. Can be cut to size.
Size: 90 x 30cm
Code 90503 £7.99

TUBE FLY BOXES

Small Water-proof Tube Fly Case CF1208 (8-Tubes)

Secure and protect your valuable tube flies in 8 clear tubes each 8cm long. Micro slit foam on the other side holds your hooks and conventional flies together with two storage wells for small components like tubing and cones etc.

Weight: 123g **Size:** 13.0 x 10.4 x 3.6cm
Code 21A0106 £38.99



Medium Waterproof Tube Fly Case CF2403V

Medium sized waterproof tube fly cases with 3 long tube fly compartments with a clear lid and a micro slit foam face with 2 storage wells for hooks, beads or connectors. Slots for 20 flies or hooks.

Weight: 144g **Size:** 15.5 x 10.5 x 4.0cm
Code 15A0270 £37.99



Wychwood VUEfinder Tube Fly Box

A tube fly box that is waterproof, has large compartments for the biggest flies, small ones for hooks and is also clear so that you can see the contents.
Size: 15 x 9cm

Code 11A0290 £18.99



Eumer Tube Fly Box

A simple way to store your tube flies and keep them organised. Tube flies secure to 36 tapered spikes which can be turned for easy access and to help dry the flies quickly when you've finished fishing.
Size: 13 x 10 x 4cm

Code 11A0105 £23.99



Fulling Mill Tube Fly Box

This lightweight & robust box features an interchangeable, interlocking storage system that guarantees the perfect solution for even your smallest tube flies and hooks and ensures that nothing moves from one compartment to another. Customisable into 16 different sized compartments.

Size: 21 x 15 x 3cm
Code 18A0070 £11.95



WALLETS



Sportfish Leather Fly Wallet

Handsome, sheepskin lined fly wallet with zip closure. Perfect for storing and drying off streamers, wet flies and lures.

Code F14A0543 £59.99



Wychwood Fly Wallet

Made from hardwearing cordura material with a strong and secure zip. Being made of breathable materials it's ideal for drying your wet flies and preventing rusty hooks. Available with either ripple foam or natural sheepskin inserts.

- D** Ripple Foam **£19.99**
- E** Sheepskin **£14.99**

Code 19A0048

FLY THREADERS

C&F Spare Threaders

Two sizes and two lengths, long or short. Standard (Blue) Flies 12-18 Midge (Pink) Flies 18-26. 4-pack.

Code 11939 £11.99



Magnetic Fly Threader

- 'The best fly threader in the world.'
- Very easy to use. Works with all flies from size 6 to 24!
- An essential tool for low light conditions and for those with less than perfect eyesight
- Magnetic notch firmly holds the eye in place
- The fly is perfectly aligned with the leader every time

Code 60465 £19.49

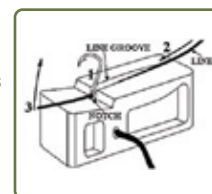

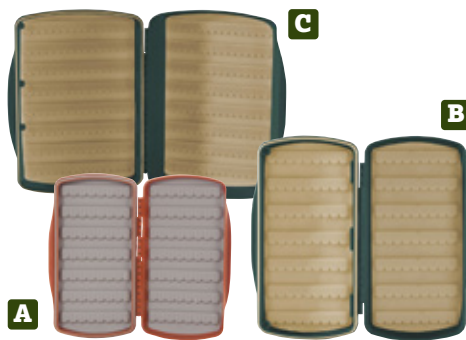

Tacky Pescador Fly Boxes

Rugged, double-sided fly boxes made from 100% recycled plastic, using Tacky's signature silicone fly anchoring inserts. Designed with a 100% waterproof closure and tested for long-lasting durability to provide many seasons of use.

Colours:

Baja Blue (all 3 sizes)

Burnt Orange (standard size only)

Code 21A0013

Model	Size	Capacity	Price
A Standard	18.4 x 10.2 x 3.0cm	210 Flies	£39.99
B Large	22.4 x 12.5 x 5.0cm	238 Flies	£49.99
C XLarge	27.0 x 19.8 x 7.6cm	464 Flies	£69.99

Optional add-on fly pages are available for the Large and XLarge boxes.

Large extra leaf - 147 extra flies **£24.99**

XLarge extra leaf - 610 extra flies **£34.99**

Tacky Original Box

The original Tacky box is made from durable, shatter-resistant recycled polycarbonate with a strong, latchless magnetic closure. The interior silicone pad holds flies tighter, doesn't absorb water, withstands extreme temperatures and doesn't get torn up by hooks. Two versions available: Single or double-sided.

Size: 17.7 x 9.5 x 2cm

Code 19B0053

Single Sided,
Holds 168 flies **£24.99**

Code 19B0054

Double Sided,
Holds 336 flies **£29.99**

Tacky Day Pack Box

A smaller version of the Original Box but with the same great features. Two versions available: Single or double-sided.

Size: 12.7 x 8.2 x 2cm

Code 19B0055

Single Sided,
Holds 90 flies **£19.99**

Code 19B0056

Double Sided,
Holds 180 flies **£24.99**

Other Tacky Fly boxes are available, please visit www.sportfish.co.uk or telephone 01544 327 111 for more information.



Vision Slim Fly Boxes

Made from super strong plastic with a clear see-through lid for quick and easy fly selection. Flies are held securely in neat, organised rows in high quality pre-slotted foam.

Code 21A0012

Model	Size	Capacity	Price
D Small	11.0 x 7.5 x 1.2cm	84 Flies	£6.99
E Medium	12.8 x 9.8 x 1.2cm	120 Flies	£7.99
F Large	18.7 x 9.8 x 1.2cm	180 Flies	£9.99
G Magnum 12 Row	31.0 x 22.0 x 2.0cm	348 Flies	£29.99
H Magnum 18 Row	31.0 x 22.0 x 2.0cm	522 Flies	£29.99

FLY PATCHES

Magnet-ique MagMini Single

The strong magnet on the MagMini Single will securely hold several of your favourite flies, hold your droppers when changing flies and even help you find your dropped flies. The MagMini Single magnetically attaches to your vest, clothing or pack. Made in the UK.

Code 19A0131 £14.99

Magnet-ique MagMicro

A multi-purpose, 32mm magnetic fly patch that magnetically attaches to your jacket, vest, pack or waders. Safely store and dry your flies on the water or at your vice.

Colours: Purple, Orange

Code 20A0052 £9.99

Sportfish Leather Double Fly Patch

Quality leather and sheepskin makes this the perfect way to keep your favourite flies close to hand. Fastens with a clip to your vest.

Code F14A0545 £34.99

Tacky Fly Dock 2.0

Store, protect and organise your flies of any size on this quick-access pad. Sticks to any hard surface using the included 3M™ adhesive strip or adhesive backed Velcro® strip.

Size: 8.2 x 2.2 x 1cm

Code 19B0061 £8.99



Fulling Mill Fly Boxes

Fulling Mill fly boxes are made from a super-tough, lightweight, polycarbonate shell with stainless steel hinges and precisely engineered, high-density, slit-foam which holds your flies securely. They are designed and manufactured in the UK.

N



Code 20B0012

Name	Description	Size	Price
I Pocket	Single Sided - 122 flies	11.9 x 8.3 x 1.7cm	£11.50
J Stealth	Single Sided - 260 flies	18.6 x 10.4 x 1.7cm	£17.50
K Streamer	Single Sided - 60 flies	18.6 x 10.4 x 3.0cm	£21.00
L Tactical	Double Sided - 520 flies	18.6 x 10.4 x 3.0cm	£21.00
M Tactical Max	Double sided + insert - 960 flies	18.6 x 10.4 x 3.0cm	£34.00
N Guide	Single Sided - 672 Flies	28.0 x 18.6 x 2.4cm	£38.00

Wychwood VUEfinder Flypatch

Keep your favourite flies close to hand with this clip-on fly box. Stores up to 38 flies in slotted foam and includes fast-attach magnetic fly holders, a hook sharpener and a ripple foam fly dryer. Clips to almost any clothing or bag. Swivels through 360° and can be opened one-handed. A must for river, boat or bank fishing.

Size: 8 x 8 x 3cm

Code 19A0046 £16.99



C&F Cap Fly Patch

A magnetic fly patch that is held securely to your cap or vest with a locked pin. Your most precious flies are held firmly in place by 8 strong magnets.

Code 19A0123 £19.99

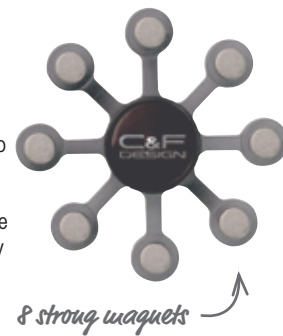

Simms Super Fly Patch

Made from durable rippled foam. Simple Velcro® attachment onto any Simms Fly vest or jacket.

Size: 8 x 5cm

Code 11A0086 £7.99





STEVE PETERSON

Flyfish Europe Sales
Representative for UK &
Ireland, AAPGAI Master Fly
Fishing Instructor

WADERS & WADING

For most fly fishers waders are essential gear for both river and stillwater angling and today's angler has more choice than ever before with modern materials, such as GORE-TEX®, making wearing them a comfortable and pleasant experience.

Non-breathable waders

Non-breathable waders are constructed from materials such as neoprene, PVC or nylon. They come with boots attached, which can have studded or cleated soles, and they are a less expensive option for infrequent fishers, for emergency use or for pond maintenance etc.

Breathable waders

Breathable waders are all about comfort. They are lightweight and, importantly, wick moisture away from the body so that even in tough conditions you forget you are wearing them and can just concentrate on your fishing. Breathable waders perform well in both warm and cold conditions but it is important what you wear underneath them. Jeans are not suitable as they act as a barrier to moisture control, so it is important to wear appropriate wicking base layers. Breathable waders fit better than other types of wader, for example the Simms G3 Guide range comes in 25 different sizes. It is important to get a good fit, not just for comfort and looks, but ill-fitting waders with excess material can wear prematurely and you don't want excess material flapping around your legs when wading in a fast flow.

Wading boots

Most breathable waders come with neoprene stocking feet and so require separate wading boots. Modern wading boots offer excellent comfort and ankle support and come in different sole options. Specialist treads, such as Simms Vibram® Idrogrip feature the latest components to maximise underfoot stability and slip resistance.

Felt soles

Felt soles have been around for a long time and offer excellent grip on rock and gravel however, they are prone to slip on wet grass, mud and snow and metal studs can be added to help grip in these more slippery conditions. In some parts of the world felt soles are banned due to the risk of accidental transportation of invasive species, so it is advisable to check before travelling.

Rubber soles

Rubber soles are great for general all-round use, generally giving better grip on mud, wet grass and snow and they can also be studded or cleated for extra grip if required. The choice of felt or rubber is down to personal preference and to experience in different terrains; frequent fishers may carry both options to cater for all situations.

There are many different breathable waders on the market at various price points and the best are a good combination of breathability with durability. If you are a regular fisher then breathable waders are the recommended option and taking a little extra care of them will greatly extend their useful life.

BREATHABLE WADER CARE AND MAINTENANCE

Pinholes, scrapes and tears

The most common problems that occur in GORE-TEX® and other breathable garments are pinholes, scrapes and tears (we use the term 'pinhole' to identify any small violation of the breathable fabric that allows moisture to penetrate the interior of the garment) and these are usually caused by thistles, thorns, hooks and sharp rocks etc. Most thistles and thorns are deflected by the fabric, but sooner or later some of them will find a way through the weave and cause leaks. To avoid this, think carefully when walking the banks and go around thorn bushes or other potentially damaging objects, instead of right through them, and don't sit on any rough or sharp surfaces.

Inner leg abrasion

Inner leg abrasion is usually related to wrong sizing or heavy wear and is caused by the fabric inside the legs rubbing together when walking. Selecting the right size when making your purchase is extremely important to ensure that you prolong the life of your waders. You should also note that long days of walking and wading may result in fabric abrasions along the back edge of the seam, this is easy to repair and is a common wear and tear issue.

Proper care and storage

After each fishing session make sure to allow the product to dry properly before you store it.

Waders, jackets and packs etc. should be hung in a vented, warm and dry place and all boots should be properly dried before being put away. If clothes or boots/shoes are stored wet or damp then over time mildew, a form of fungus, will start to grow on them and this has the potential to cause severe damage.

On waders and jackets mildew causes problems such as seam tape lifting (the seam tape on neoprene feet and GORE-TEX® seam tape inside the garment comes off). Delaminating of the fabric can also occur. Common for all products is that the growth of mildew starts a general material breakdown as it produces enzymes that convert the cellulose or protein in the fabric into the compounds on which it feeds - basically speaking, mildew slowly breaks down the garment and eats it!

After gear is properly dried it should always be stored in a cool, dry environment with adequate ventilation. If a product is infested by mildew it should be isolated by sealing it in a polythene bag and either disposed of immediately, or sent to trained professionals for decontamination.

Self-repairs

If you get leaks along any seam in a waterproof, breathable garment you should not do a self-repair to those areas. Most reported seam leaks are, in fact, pinholes along the seam tape and not a true seam leak. Aquaseal or other adhesives do not come off and any self-repair that is done along a seam may potentially void your warranty as manufacturers cannot remove and correct the problem without destroying the seam.

REVIVEX® application and upkeep

Over time and with exposure to rushing water, long days in the rain, dirt and other factors your GORE-TEX® garment may begin to 'wet out' and no longer repel water effectively from the surface fabric. This is usually a result of the DWR (Durable Water Repellency) wearing off. Although water isn't leaking all the way through the garment, it may feel and look like it is because 'wet out' reduces breathability and creates excess interior condensation making you feel damp and cold. It is easily addressed with the use of REVIVEX® but do follow the instructions carefully.





“Features every ounce of Simms high-performing wader DNA in an affordable wader”



Reach-through fleece lined handwarming pocket

3-layer upper & 4-layer lower

2023 Simms Tributary Stockingfoot Waders

The best value in wading, the Tributary collection from Simms features every ounce of Simms high-performing wader DNA in an affordable wader. Durable, dry, breathable performance with natural mobility thanks to an articulated fit.

Key Features

- Breathable & comfortable waterproof polyester 3-layer upper & 4-layer lower
- Reach-through fleece lined handwarming pocket, with zipped top stash pocket and integrated fly patch
- Single rear belt loop with 1 1/2" wading belt
- Built-in gravel guards with gathered elastic bottom hem
- Anatomically engineered neoprene stockingfeet with antimicrobial finish

Colour: Basalt

Code 23A0017 £249.00

Size	Largest Girth (Chest, Waist or Hip)	Inseam (Crotch to Floor)	UK Stockingfoot
Small	35-36"	31-32"	6-7
Medium	39-40"	33-34"	8-10
Medium Short	39-40"	31-32"	8-10
Medium King	41-42"	33-34"	8-10
Medium Long	39-40"	35-36"	8-10
Large (8-10)	43-44"	33-34"	8-10
Large Short	43-44"	31-32"	8-10
Large King	45-46"	33-34"	8-10
Large Long (8-10)	43-44"	35-36"	8-10
XLarge	47-48"	35-36"	11-12
XLarge Short	47-48"	33-34"	8-10
XXLarge	51-52"	35-36"	11-12



Top access stretch woven storage pocket

Durable and breathable Toray QuadraLam 4-layer upper & lower

Patented front and back leg seams



2023 Simms Freestone Stockingfoot Waders

The ultimate wader for your money, the Freestone Stockingfoot has been refined through years of testing and tweaking and is infused with decades of Simms wader DNA. Its durable, breathable 4-layer Toray® QuadraLam™ fabric handles both undergrowth and cold, wet weather, while the articulated fit promotes natural mobility both in and off the water. High-quality materials with advanced designs that bring function, performance and value to the forefront.

Key Features

- Durable and breathable Toray QuadraLam 4-layer upper & lower
- Stretch elastic suspenders with Simms custom opposing male and female buckles for easy waist-high conversion
- Upper chest pocket array features a top access stretch woven storage pocket, micro-fleece lined handwarmer pockets and integrated loop fly patch
- Patented front and back leg seams deliver articulated fit, improved mobility, and increased durability
- Dual rear belt loops with a 1 1/2" stretch elastic wading belt included

Colour: Smoke

Code 23A0016 £449.00

Available June 2023

Size	Largest Girth (Chest, Waist or Hip)	Inseam (Crotch to Floor)	UK Stockingfoot
Small	35-36"	31-32"	6-7
Medium	39-40"	33-34"	8-10
Medium Short	39-40"	31-32"	8-10
Medium King	41-42"	33-34"	8-10
Medium Long	39-40"	35-36"	8-10
Large (8-10)	43-44"	33-34"	8-10
Large (11-12)	43-44"	33-34"	11-12
Large Short	43-44"	31-32"	8-10
Large King	45-46"	33-34"	8-10
Large Long (8-10)	43-44"	35-36"	8-10
Large Long (11-12)	43-44"	35-36"	11-12
XLarge	47-48"	35-36"	11-12
XLarge Short	47-48"	33-34"	8-10
XXLarge	51-52"	35-36"	11-12



SIMMS WADER & BOOT OFFER

**SAVE
£119.99**

**SPECIAL
OFFER**

Simms Freestone® Stockingfoot Waders

Simms Freestone® waders are an affordable option suitable for challenging conditions. The waterproof 4-layer Toray® QuadraLam material breathes easily and gives total comfort and performance. The articulated, shaped legs with their centre seam improve the overall fit and help reduce abrasion. The super-warm, reach-through handwarmer pocket offers safe keeping for your valuables. The alternate braces' buckles make it easy to convert the chest waders to waist high waders.

Key Features

- Waterproof and breathable 4-layer Toray® QuadraLam material
- Articulated shaped legs with centre seam construction offer the ultimate in fit and comfort
- Fleece-lined reach-through handwarmer pocket offers secure storage
- Easy conversion to a waist high wader
- Comfortable neoprene hourglass shaped stockingfoot
- Internal zip for attaching the Tippet Tender™ Pocket or Waterproof Wader Pouch (both sold separately)

Colour: Dark Gunmetal

Code 19A0002 £419.00

Size	Largest Girth (Chest, Waist or Hips)	Inseam (Crotch to Floor)	UK Shoe Size
Small	35-36"	31-32"	6-7
Medium	39-40"	33-34"	8-10
Medium Short	39-40"	31-32"	8-10
Medium Long	39-40"	35-36"	8-10
Medium King	41-42"	33-34"	8-10
Large (8-10)	43-44"	33-34"	8-10
Large (11-12)	43-44"	33-34"	11-12
Large Short	43-44"	31-32"	8-10
Large Long (8-10)	43-44"	35-36"	8-10
Large Long (11-12)	43-44"	35-36"	11-12
Large King	45-46"	33-34"	8-10
XLarge	47-48"	35-36"	11-12
XLarge Short	47-48"	31-32"	8-10
XXLarge	51-52"	35-36"	11-12

Fleece-lined reach-through handwarmer pocket offers secure storage

Easy conversion to a waist high wader

Articulated shaped legs with centre seam construction offer the ultimate in fit and comfort

Comfortable neoprene hourglass shaped stockingfoot



FREESTONE® FELT
Code 18A0004 £199.99

YOU PAY £80.00*
SAVE £119.99



FREESTONE® RUBBER
Code 18A0004 £199.99

YOU PAY £80.00*
SAVE £119.99

*When you buy a pair of Simms Freestone® waders and a pair of Simms Freestone® boots

BOOTS & WADERS ONLY £499.00 SAVE £119.99



Dual chest pockets with fly patch

Five belt loops with 38mm nylon waist belt

Four-layer Toray® QuadraLam™ waterproof, breathable fabric

Anatomically engineered neoprene stockingfeet with anti-microbial finish

Simms Freestone® Zipped (Z) Stockingfoot Waders

The famously durable Simms Freestone® waders are now available in a zipped version featuring a YKK® AQUASEAL® waterproof front zip, making them easier to get in and out of – especially useful for when nature calls!

Built with rugged and breathable four-layer Toray® QuadraLam™ fabric to help protect you from prickly bankside vegetation, whilst an articulated fit helps to preserve your body's natural mobility both in and out of the water.

When it comes to small details that make a difference, the Freestone® Z waders include two large fleece-lined handwarmer pockets to warm up cold fingers and dual chest pockets with built-in magnetic retainers to help keep tools and flies at the ready.

Practical, ergonomic and built to last, the Freestone® Z Stockingfoot Waders put comfort and durability at the forefront, ensuring that you make the most of each day spent out on the water.

Key Features

- Four-layer Toray® QuadraLam™ waterproof, breathable fabric
- YKK® AQUASEAL® waterproof front zip for easy access and quick relief on the river
- Dual chest pockets with fly patch
- Interior zip closure chest pocket
- Five belt loops with 38mm nylon waist belt
- Custom Duraflex buckles throughout
- Neoprene gravel guards
- Anatomically engineered neoprene stockingfeet with anti-microbial finish

Code 19A0014 £419.00

Size	Largest Girth (Chest, Waist or Hip)	Inseam (Crotch to Floor)	UK Stockingfoot
Small	35-36"	31-32"	6-7
Medium	39-40"	33-34"	8-10
Medium King	41-42"	33-34"	8-10
Large (8-10)	43-44"	33-34"	8-10
Large King	45-46"	33-34"	8-10
XLarge	47-48"	35-36"	11-12
XXLarge	51-52"	35-36"	11-12

SIMMS WADER & BOOT OFFER

SPECIAL OFFER

Simms Tributary® Stockingfoot Waders

The Simms Tributary Stockingfoot Wader is built with proven Simms expertise and durability using a waterproof breathable polyester fabric.

Key Features

- 3-layer Waterproof Breathable Polyester upper body
- 4-layer Waterproof Breathable Polyester on the lower section
- Zipped storage pocket
- Reach-through fleece-lined handwarmer pocket
- Self-fabric gravel guard with gathered elastic bottom hem
- Anatomically engineered neoprene stockingfeet with anti-microbial finish
- Two belt loops with 38mm nylon waist belt

Code 19A0013 £249.00



Size	Largest Girth (Chest, Waist or Hips)	Inseam (Crotch to Floor)	UK Shoe Size
Small	35-36"	31-32"	6-7
Medium	39-40"	33-34"	8-10
Medium Short	39-40"	31-32"	8-10
Medium King	41-42"	33-34"	8-10
Medium Long	39-40"	35-36"	8-10
Large (8-10)	43-44"	33-34"	8-10
Large Short	43-44"	31-32"	8-10
Large King	45-46"	33-34"	8-10
Large Long (8-10)	43-44"	35-36"	8-10
XLarge	47-48"	35-36"	11-12
XLarge Short	47-48"	33-34"	8-10
XXLarge	51-52"	35-36"	11-12



TRIBUTARY® FELT
Code 21A0059 £159.99

**YOU PAY £80.00*
SAVE £79.99**



TRIBUTARY® RUBBER
Code 21A0059 £159.99

**YOU PAY £80.00*
SAVE £79.99**

*When you buy a pair of Simms Tributary® waders and a pair of Simms Tributary® boots

**BOOTS & WADERS ONLY
£329.00 SAVE £79.99**



Built-in low-profile back belt loops

MICROBAN® antimicrobial protection inhibits the growth of odour-causing bacteria and fights mildew growth



Simms G3 Guide Boot
SEE PAGE 112

Simms G3 Guide™ Stockingfoot Waders

Simms' legendary, award-winning waders are back with upgraded materials, added features and an improved fit. With a new fabric system which includes 4-layer GORE-TEX® Pro Shell on the lower areas, the G3 is now 23% more durable and 33% more breathable than before. Added features like adjustable air-mesh suspenders and a clever pocket layout ensure all day comfort and practicality.

Key Features

- 4-layer GORE-TEX® Pro Shell lower and 3-layer GORE-TEX Shell upper for optimised breathability, rugged durability and waterproof protection
- Patented articulated leg seams for comfort and mobility
- Top access zipped stretch pocket, reach-through fleece lined handwarmer chest pocket, internal stretch-woven flank pocket and removable tippet tender pocket
- Built-in low-profile back belt loops with high and low options with 1½inch stretch nylon wading belt included
- MICROBAN® antimicrobial protection inhibits the growth of odour-causing bacteria and fights mildew growth
- Made in Bozeman, Montana, USA.

Colour: Gunmetal Code **22A0001 £799.00**

Size	Largest Girth (Chest, Waist or Hip)	Inseam (Crotch to Floor)	UK Stockingfoot
Small	35-36"	31-32"	6-7
Small King	37-38"	31-32"	6-7
Medium	39-40"	33-34"	8-10
Medium Short	39-40"	31-32"	8-10
Medium Long	39-40"	35-36"	8-10
Medium King	41-42"	33-34"	8-10
Medium King Short	41-42"	29-30"	8-10
Large	43-44"	33-34"	8-10
Large Short	43-44"	31-32"	8-10
Large Long	43-44"	35-36"	8-10
Large King	45-46"	33-34"	8-10
Large King Short	45-46"	31-32"	8-10
XLarge	47-48"	35-36"	11-12
XLarge Short	47-48"	31-32"	8-10
XLarge Long	47-48"	37-38"	11-12
XXLarge	51-52"	35-36"	11-12



Reach-through handwarmer chest pocket with zipped top stash pocket

Internal, flip-out, zip secure pocket keeps your essentials close at hand



Simms Freestone® Boot
SEE PAGE 113

Simms Guide Classic Stockingfoot Waders

Made in Montana, USA, with legendary GORE-TEX® Pro shell waterproof-breathable fabrics, the Guide Classic Stockingfoot Waders are a proven performer in fishing environments across the world, and this model is the latest design. Your feet will be comfortable all day long in anatomically engineered neoprene booties with built-in gravel guards. There are plenty of places to store important items, with a reach-through handwarmer chest pocket, a zip top pocket as well as a flip-out zip secure internal pocket. 3-Layer GORE-TEX® Pro shell provides breathability to keep you fishing comfortably all day long.

Key Features

- Reach-through handwarmer chest pocket with zipped top stash pocket
- Internal, flip-out, zip secure pocket keeps your essentials close at hand
- Anatomically engineered neoprene stockingfeet with built-in gravel guards

Colour: Carbon

Code **21A0045 £599.00**

Size	Largest Girth (Chest, Waist or Hip)	Inseam (Crotch to Floor)	UK Stockingfoot
Small	35-36"	31-32"	6-7
Medium	39-40"	33-34"	8-10
Medium Short	39-40"	31-32"	8-10
Medium King	41-42"	33-34"	8-10
Medium Long	39-40"	35-36"	8-10
Large (8-10)	43-44"	33-34"	8-10
Large (11-12)	43-44"	33-34"	11-12
Large Short	43-44"	31-32"	8-10
Large King	45-46"	33-34"	8-10
Large Long (8-10)	43-44"	35-36"	8-10
Large Long (11-12)	43-44"	35-36"	11-12
XLarge	47-48"	35-36"	11-12
XLarge Short	47-48"	33-34"	8-10
XLarge King	49-50"	35-36"	11-12
XXLarge	51-52"	35-36"	11-12



Adjustable air-mesh suspender system with net D-ring



Built-in, low profile belt loops

Front & back leg seams for increased durability & mobility



Simms Pro Wading Staff
SEE PAGE 122

Simms G4 Pro® Stockingfoot Waders

Simms G4 Pro® waders are built around a GORE-TEX® proprietary fabric with 3-layer GORE-TEX® Pro Shell in the upper body and 4-layer GORE-TEX® Pro Shell in the lower body for enhanced durability. The design of the compression-moulded, anatomically engineered stockingfeet ensures all-day comfort in your wading boots. Simms unique leg seams at the front & back increase comfort and durability. These are the most feature-laden, abrasion, puncture and tear-resistant waders Simms has ever made.

Key Features

- Adjustable air-mesh suspender system with net D-ring
- Compression-moulded stockingfeet for improved boot fit & comfort
- Zipped chest pocket with fly patch & tool docking station
- Zipped, fleece-lined handwarmer pocket
- Built-in low profile belt loops
- Sharkfin buckle for storing your forceps or haemostats
- Front & back leg seams for increased durability & mobility
- 2mm abrasion resistant built-in gravel guards

Colour: Slate

Code 20A0002 £849.00

Size	Largest Girth (Chest, Waist or Hip)	Inseam (Crotch to Floor)	UK Stockingfoot
Small	35-36"	31-32"	6-7
Medium	39-40"	33-34"	8-10
Medium Short	39-40"	31-32"	8-10
Medium King	41-42"	33-34"	8-10
Medium Long	39-40"	35-36"	8-10
Large (8-10)	43-44"	33-34"	8-10
Large (11-12)	43-44"	33-34"	11-12
Large Short	43-44"	31-32"	8-10
Large King	45-46"	33-34"	8-10
Large Long (8-10)	43-44"	35-36"	8-10
Large Long (11-12)	43-44"	35-36"	11-12
XLarge	47-48"	35-36"	11-12
XLarge Short	47-48"	33-34"	8-10
XXLarge	51-52"	35-36"	11-12

Additional sizes are available please visit www.sportfish.co.uk or call 01544 327111 for more information.



Zipped, fleece lined handwarmer pocket



Waterproof YKK front zip for convenience, quick relief and easy on-off



Simms G4 PRO Powerlock Boots
SEE PAGE 112

Simms G4Z® Stockingfoot Waders

Simms G4Z® waders have all the features of the G4 Pro waders but with the added advantage of a long, waterproof YKK front zip for convenience, quick relief and easy on-off. These too are built around a GORE-TEX® proprietary fabric with 3-layer GORE-TEX® Pro Shell in the upper body and 4-layer GORE-TEX® Pro Shell in the lower body for enhanced durability. The design of the compression-moulded, anatomically engineered stockingfeet ensures all-day comfort in your wading boots. Simms unique leg seams at the front & back increase comfort and durability. These are the most feature-laden, abrasion, puncture and tear-resistant waders Simms has ever made.

Key Features

- Waterproof YKK front zip for convenience, quick relief and easy on-off
- Adjustable air-mesh suspender system with net D-ring
- Compression-moulded stockingfeet for improved boot fit & comfort
- Two zipped chest pockets with a fly patch & tool docking station
- Zipped, fleece-lined handwarmer pocket
- Built-in low profile belt loops
- Sharkfin buckle for storing your forceps or haemostats
- Leg seams at front & back for increased durability & mobility
- Built-in abrasion resistant gravel guards

Colour: Slate

Code 20A0003 £1079.00

Size	Largest Girth (Chest, Waist or Hip)	Inseam (Crotch to Floor)	UK Stockingfoot
Small	35-36"	31-32"	6-7
Medium	39-40"	33-34"	8-10
Medium Short	39-40"	31-32"	8-10
Medium King	41-42"	33-34"	8-10
Medium Long	39-40"	35-36"	8-10
Large (8-10)	43-44"	33-34"	8-10
Large (11-12)	43-44"	33-34"	11-12
Large Short	43-44"	31-32"	8-10
Large King	45-46"	33-34"	8-10
Large Long (8-10)	43-44"	35-36"	8-10
Large Long (11-12)	43-44"	35-36"	11-12
XLarge	47-48"	35-36"	11-12
XLarge Short	47-48"	33-34"	8-10
XXLarge	51-52"	35-36"	11-12



A large zipped front pocket

Matching colour elastic belt and braces

Curved NoSeam™ cut for perfect fit

Lightweight 3-layer construction



Vision Atom Boot
SEE PAGE 114



Waterproof and breathable F3™ fabric

Vision Atom Waders

Affordable, lightweight, durable waders made with F3™ 3-layer fabric. The Atom's cut minimises seams in critical areas and the neoprene socks have denser bottom parts for maximum durability. A large zipped chest pocket and inner flip pocket provide lots of storage. The elastic, adjustable braces and belt allow you to adjust the fit for your maximum comfort.

Key Features

- Lightweight 3-layer construction
- Waterproof and breathable F3™ fabric
- Curved NoSeam™ cut for perfect fit
- A large zipped front pocket
- Matching colour elastic belt and braces
- Built-in gravel guards
- Anatomical neoprene feet with left and right fit

Code 20A0055 £199.99

Size	Largest Girth	Inseam	UK Shoe Size
Small	34-37"	29-31"	6-8
Medium	38-41"	31-33"	7-9
Large	42-45"	32-34"	9-11
XLarge	46-49"	32-34"	10-12
XXLarge	50-53"	33-35"	11-13



Lightweight 4-layer construction

Waterproof and breathable F4™ fabric

D-rings & accessory loops and straps

A large zipped front pocket



Vision Koski Boot
SEE PAGE 114



Anatomical neoprene feet with left and right fit

Vision Koski Waders

Vision Koski Waders are made from the latest technical T4™ fabric for performance & comfort. The lower body is woven using thicker material for increased durability. The curved NoSeam™ cut on each leg provides the perfect fit. Specially designed neoprene feet, a large zipped front pocket, a clear flip-out TPU waterproof pouch and numerous accessory loops and straps take these Koski waders to the next level.

Key Features

- Lightweight 4-layer construction
- Waterproof and breathable F4™ fabric
- Curved NoSeam™ cut for perfect fit
- A large zipped front pocket
- Flip-out clear TPU pocket
- D-rings & accessory loops and straps
- Waterproof & removable TPU pocket
- Built-in gravel guards
- Anatomical neoprene feet with left and right fit

Code 20A0012 £299.00

Size	Largest Girth	Inseam	UK Shoe Size
Small - Regular	34-37"	29-31"	6-8
Medium - Short	38-41"	28-30"	7-9
Medium - Regular	38-41"	31-33"	7-9
Medium - Long	38-41"	33-35"	7-9
Medium - King	42-45"	31-33"	7-9
Large - Short	42-45"	29-31"	9-11
Large - Regular	42-45"	32-34"	9-11
Large - Long	42-45"	33-35"	9-11
Large - King	46-49"	32-34"	9-11
XLarge - Short	46-49"	29-31"	10-12
XLarge - Regular	46-49"	32-34"	10-12
XLarge - King	50-53"	32-34"	10-12
XXLarge - Regular	50-53"	33-35"	10-12



Two large zipped front pockets

Curved NoSeam™ cut for perfect fit



Vision Koski Boot
SEE PAGE 114



Anatomical neoprene feet with left and right fit

Vision Koski Zip-Front Waders

The Vision Koski Zip-Front Waders have all the same features as the standard Koski waders but with the added advantage of a waterproof, TiZip® Masterseal 10 front zip for convenience, quick relief and easy on-off. Vision Koski Waders are made from the latest technical T4™ fabric for performance & comfort. The lower body is woven using thicker material for increased durability. The curved NoSeam™ cut on each leg provides the perfect fit. Specially designed neoprene feet, two large zipped front pockets, a flip-out, clear TPU waterproof pouch and numerous accessory loops and straps take these Koski Zip-Front waders to the next level.

Key Features

- TiZip® Masterseal 10 front zip
- Waterproof and breathable 4-layer F4™ fabric
- Curved NoSeam™ cut for perfect fit
- Two large zipped front pockets
- D-rings & accessory loops and straps
- Waterproof & removable TPU pocket
- Built-in gravel guards
- Anatomical neoprene feet with left and right fit

Code 20A0013 £399.00

Size	Largest Girth	Inseam	UK Shoe Size
Small - Regular	34-37"	29-31"	6-8
Medium - Short	38-41"	28-30"	7-9
Medium - Regular	38-41"	31-33"	7-9
Medium - Long	38-41"	33-34"	7-9
Medium - King	42-45"	31-33"	7-9
Large - Short	42-45"	29-31"	9-11
Large - Regular	42-45"	32-34"	9-11
Large - Long	42-45"	33-35"	9-11
Large - King	46-49"	32-34"	9-11
XLarge - Regular	46-49"	32-34"	10-12
XLarge - King	50-53"	32-34"	10-12
XXLarge - Regular	50-53"	33-35"	11-13

Vision Koski Guiding Waders (Waist)

With many of the same attributes as the standard Koski wader, this half wader choice is perfect for those situations where deep wading is not necessary. With matching detachable braces and additional belt loops these are the perfect alternative in warmer conditions.

Key Features

- Lightweight 4-layer construction
- Waterproof and breathable F4™ fabric
- Curved NoSeam™ cut for perfect fit
- Adjustable, removable matching colour braces
- Built-in gravel guards
- Anatomical neoprene feet with left and right fit

Code 20A0014 £269.00



Adjustable, removable matching colour braces

Curved NoSeam™ cut for perfect fit

Anatomical neoprene feet with left and right fit

Size	Waist	Inseam	UK Shoe Size
Medium	32-36"	31-33"	7-9
Large	37-41"	32-34"	9-11
XLarge	42-46"	32-34"	10-12
XXLarge	47-49"	32-34"	10-12

Vision Koski Hip Waders (Thigh)

The Koski hip wader is perfect for the roaming angler who travels light. Easily packable you can be in and out of these at a moment's notice. Ideal for the riverbank angler to step into the shallow margins and maintain a low profile.

Key Features

- Lightweight 4-layer construction
- Waterproof and breathable F4™ fabric
- Built in gravel guard with lace hooks
- Anatomical neoprene feet with left and right fit

Code 20A0015 £189.99



Lightweight 4-layer construction

Waterproof and breathable F4™ fabric

Built in gravel guard with lace hooks

Size	Largest Girth	Inseam	UK Shoe Size
Medium	-	31-33"	7-9
Large	-	32-34"	9-11
XLarge	-	32-34"	10-12



Patagonia Swiftcurrent Expedition Waders

The Swiftcurrent Expedition Waders are the toughest, most feature-rich waders ever made by Patagonia. Completely redesigned with a durable, ultra-supple, 4-layer waterproof H2No® 100% recycled polyester microfibre shell with a DWR (durable water repellent) finish to keep you fishing in comfort through the most extreme conditions. The fully articulated legs with a single seam and gusseted crotch provide enhanced durability and unparalleled freedom of movement. Other key features include: an adjustable quick-release suspender system for conversion from chest to waist height, an interior waterproof pocket, a handwarmer pocket with zip flaps and anatomical stockingfeet.

Key Features

- Height adjustable suspenders with padded shoulder straps
- Secure Stretch wading belt
- Large zipped chest pocket
- Reach-through handwarmer pocket with built-in flaps
- Interior waterproof flip-out pocket
- Two drop-in stretch pockets
- Daisy chains for tool-attachment
- Top hem drawcord
- Removable foam kneepads
- Anatomical L & R booties

Colour: Forge Grey

Code F20A0122 £650.00

Large zipped chest pocket



Patagonia Wading Staff
SEE PAGE 122

Size	Largest Girth (Chest, Waist or Hip)	Inseam (Crotch to Floor)	UK Stockingfoot
SRM	37"	32"	8-10
MSM	40"	30"	8-11
MRM	40"	32"	8-10
MRL	40"	32"	10-12
MLM	40"	34"	8-10
LSM	44"	30"	8-10
LRM	44"	32"	8-10
LRL	44"	32"	10-12
LLL	44"	34"	10-12
XSM	48"	30"	8-10
XRL	48"	32"	10-12
XLL	48"	34"	10-12

Additional sizes are available please visit www.sportfish.co.uk or call 01544 327111 for more information.

Height adjustable suspenders with padded shoulder straps

Patagonia Swiftcurrent Expedition Zip-Front Waders

The Swiftcurrent Expedition Zip-Front Waders have all the same award-winning features as the Expedition waders but with the added advantage of a waterproof YKK® front zip for convenience, quick relief and easy on-off. They are the toughest, most feature-rich waders ever made by Patagonia. Completely redesigned with a durable, ultra-supple, 4-layer H2No® 100% recycled polyester microfibre shell with a DWR (durable water repellent) finish to keep you fishing in comfort through the most extreme conditions. The fully articulated legs with a single seam and gusseted crotch provide enhanced durability and unparalleled freedom of movement. Other key features include - an adjustable quick-release suspender system for conversion from chest to waist height, an interior waterproof pocket, a handwarmer pocket with zip flaps and anatomical booties.

Key Features

- Fully submersible waterproof YKK® front zip
- Height adjustable suspenders with padded shoulder straps
- Secure Stretch wading belt
- Large zipped chest pocket
- Reach-through handwarmer pocket with built-in flaps
- Interior waterproof flip-out pocket
- Two drop-in stretch pockets
- Daisy chains for tool attachment
- Top hem drawcord
- Removable foam kneepads
- Anatomical L & R booties

Colour: Forge Grey

Code F20A0121 £699.00

Anatomical L & R booties



Size	Largest Girth (Chest, Waist or Hip)	Inseam (Crotch to Floor)	UK Stockingfoot
SRM	37"	32"	8-10
MSM	40"	30"	8-11
MRM	40"	32"	8-10
MRL	40"	32"	10-12
MLM	40"	34"	8-10
LSM	44"	30"	8-10
LRM	44"	32"	8-10
LRL	44"	32"	10-12
LLL	44"	34"	10-12
XSM	48"	30"	8-10
XRL	48"	32"	10-12
XLL	48"	34"	10-12



Patagonia Foot Tractor Wading Boots

Hand built by Danner® and featuring a treated full-grain leather for toughness and longevity, which also shapes to your foot for a fit like no other. The boot upper, with its heavy-duty nylon upper panels, is stitched to a 5mm rubber top midsole giving you stability underfoot. The bottom midsole is made from water-resistant polyurethane which adds comfort, support and toughness. The boots feature "Recraftable Stitchdown Construction" so if over time you wear down the soles, your boots can be returned and resoled.

Available with 3 sole options:

A Vibram® Idrogrip Rubber. This "sticky" rubber offers incredible durability and grip on wet rocks. Each pair comes with a pack of studs.

B Felt. Studs can be screwed into this solid felt sole for added grip.

C Aluminium Bars. A combination of Vibram® Idrogrip and aluminium bars.

Key Features

- Waterproof treated full-grain leather
- Durable and repairable "Recraftable Stitchdown Construction"
- Durable heavy-duty nylon upper side panels
- Perforated quick drain holes on both sides
- Adjustable speed lacing system

Sizes: UK8-UK11

Code **F20A0125**

A Vibram® Idrogrip Rubber **£420.00**

B Felt **£420.00**

C Aluminium Bars **£470.00**

Durable and repairable "Recraftable Stitchdown Construction"



Choice of three sole options



Waterproof treated full-grain leather

Patagonia River Salt Wading Boots

Hand built by Danner® and designed to be lighter for wet-wading, flats-fishing and long walks to your favourite fishing spots. They feature the same waterproof full-grain leather, dual-sided perforated drain holes, heavy-duty nylon upper panels and durable and repairable "Recraftable Stitchdown Construction" as found in the award-winning Foot Tractor wading boots. They also benefit from non-metal, rust-proof, lace guides and use an innovative one-piece bi-fit board midsole that combines the shank, lasting board and midsole, significantly reducing weight without sacrificing support and protection. The non-marking and boat friendly Vibram® Megagrip rubber sole is designed for maximum grip on both wet and dry surfaces and can accept studs.

Key Features

- Waterproof treated full-grain leather
- Durable and repairable "Recraftable Stitchdown Construction"
- Durable heavy-duty nylon upper side panels
- Perforated quick drain holes on both sides
- Adjustable non-rust lacing system

Sizes: UK8-UK11

Code **F20A0126 £380.00**



Reinforced toe caps for technical wading

Patagonia Forra Wading Boots

Engineered to be lightweight without sacrificing performance, perfect for longer overland approaches and for reliability in all types of wading. Built with Vibram® Mars sole technology for traction and grip, these boots feature a high ankle, sturdy toe box and adjustable, noncorrosive lacing system for support and durability. The abrasion-resistant Cordura® nylon mesh upper ensures quick-drying, durable, lightweight support.

Key Features

- Lightweight and durable
- High collar design for ankle protection and stability
- Reinforced toe caps for technical wading
- Engineered to clear water quickly and for faster dry times
- Adjustable webbing lacing system

Sizes: UK8-UK11

Code **23A0087 £230.00**

Other sizes are available to order. Please visit www.sportfish.co.uk or call 01544 327 111 for more information.



Simms G4 Pro Powerlock Boots

The most advanced wading boot on the water, the G4 Pro Powerlock Boot offers supreme durability and superior grip thanks to state-of-the-art materials working in lockstep with the new Powerlock cleat system for on-the-fly traction customisation. The boot features a waterproof synthetic Lorenzi® scratch leather upper combined with waterproof synthetic mesh for long-term durability and partial neoprene lining for comfort and easy on/off.

Key Features

- Laser-cut fabric eye stays allow fine-tune adjustments across the top of the foot and provide reliable durability
- Moulded TPU heel counter for comfort and in-stream ankle support
- Dual density EVA midsole for comfort
- Available with either Vibram® Idrogrip rubber or felt soles
- Includes two sets of G4 Pro Powerlock cleats: 14-Aluminum and 14-Orange TPR

Sizes: UK7 – UK14 **Colour:** Carbon

A Felt sole with built-in Powerlock system **£499.00**

B Vibram® Idrogrip rubber sole with built-in Powerlock system **£499.00**

Code 23A0001

Simms Replacement G4 Pro Powerlock Cleats

C Orange TPR Cleats – Pack 14 **£49.99**

D Aluminium Cleats – Pack 14 **£99.99**

Code 23A0029



A Felt sole



B Idrogrip rubber sole



C Orange



D Aluminium



Simms G3 Guide Boots

Simms G3 Guide boot is designed by and for working fishing guides. It is a quality wading boot that provides the support, durability and grip that you need to negotiate different river beds and fishing conditions with two options of soles available: 12mm felt or Vibram® Idrogrip. The boots feature secure ankle support and the RiverTread™ build gives an enhanced feel underfoot to help keep you comfortable and safe all day around and in the water. The G3 Guide™ boot gives you confidence to move across rocky river bottoms anywhere in the world.

Key Features

- Waterproof nubuck leather & lace-to-toe upper
- High abrasion textile with full scratch rubber rand
- Moulded external TPU heel counter & heel clip
- Dual-density midsole for shock absorption
- ESS plates for improved stud and cleat retention & proprioception

Sizes: UK6-UK15 **Colour:** Steel Grey

Code 18A0002

I Vibram® Idrogrip Rubber Sole **£299.00**

J 12mm Felt Sole **£299.00**

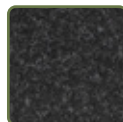

Felt sole

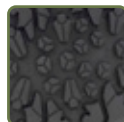

Vibram® Idrogrip sole

Simms G4 Pro Boots

The Simms G4 Pro wading boot features a highly abrasion-resistant textile mesh upper with welded TPU for increased durability. The 3D-moulded rubber toe cap and TPU heel clip provide great protection and fit. The upper speed hooks and lower eyelet lacing system ensure a quick and secure fit into your boot each time. The G4 Pro boot is fully lined with neoprene and foam for ultimate all-day comfort. The dual-density mid and outsoles provide great comfort, cushioning and stability whatever the terrain.

Key Features

- TPU welded mesh uppers for added durability
- 3D-moulded protective toe cap and heel bar
- Speed hooks and eyelet lacing system
- Neoprene and foam lined
- Dual-density mid and outsoles
- Available as two sole options

Sizes: UK6-UK14 **Colour:** Carbon

Code 20A0004

E Vibram® Idrogrip Rubber Sole **£299.00**

(Vibram Idrogrip rubber outsole with non-corrosive threaded receptacles for cleats).

F 12mm Felt Sole **£259.00** (12mm Felt with rubber pods for securing studs if required).



Felt sole



Vibram® Idrogrip sole

Simms G4 Studs Specifically for G4 Pro Boots

Removable, screw-in studs specifically for Simms G4 Pro boots with Vibram® Idrogrip soles.

G AlumiBite™ Cleat (10-Puck) **£39.99**

H HardBite™ Star Cleat (10-Puck) **£55.99**

Code 20A0105



G AlumiBite™



H HardBite™

L BOA Lacing system for simplicity and security

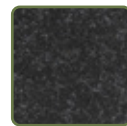

Felt sole



Vibram® Idrogrip sole



Simms Guide BOA Boots

Simms are back with the awesome and much-loved BOA system, integrated into the Guide BOA Boots. These boots are fitted with the unique BOA lacing system which provides unmatched simplicity and security. This system is particularly helpful when fishing in cold climates as finger dexterity can start to suffer! Built with plenty of strength and support to help you power past river obstacles with confidence and stability, and available in either felt or Vibram® rubber soles to suit the areas in which you fish.

Key Features

- BOA Lacing system for simplicity and security
- Full TPU coated upper for durability.
- Rubber toe and heel overlays for added protection
- Full closed-cell neoprene foam lining
- Pull-on grip loops to help you slip stockingfeet in easily
- TPU outsole plate for stud and cleat retention

Sizes: UK6 - UK13 (large and small sizes may be by special order only) **Colour:** Slate

Code 22A0003

K Vibram® Idrogrip Rubber Sole **£289.00**

L Felt Sole **£269.00**



Simms Freestone® Boots - 2023

The improved Simms Freestone® boot offers superior grip and support at a great price. The synthetic full-grain leather and scratch resistant rubber upper gives these boots both style and durability. A neoprene-lined collar enhances all-around hiking and wading capabilities. Available either with a 12mm felt sole or rubber sole.

Key Features

- Synthetic construction offers minimal water absorption
- Padded collar & tongue
- Generous gusseted tongue for easy on/off
- Moulded internal heel and toe counters for excellent fit
- Nylon speed laces minimise weight
- EVA wedge with rubber midsole provide stable footbed
- Fully neoprene lined
- High quality nylon laces

Sizes: UK4 - UK15 **Colour:** Gunmetal

Code 23A0018

A Rubber Sole **£199.99**

B Felt Sole **£199.99**

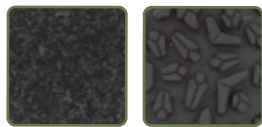

Felt sole

Rubber sole



Simms Flyweight Boots

Simms lightest ever wading boot is built for long walks or hikes to your favourite fishing spots. Despite their lightweight and low-profile design these boots provide maximum protection, stability and comfort.

The Vibram® Idrogrip rubber outsole offers great all-round grip, keeping you safe and upright in and beside the water. Simms right angled footbed together with the cushioning EVA midsole provides great comfort and shock absorption.

Key Features

- Low-profile, lightweight synthetic boot upper
- Welded TPU film in high abrasion zones for durability
- Speed lace hooks and lace-toe closure
- High cushion dual density EVA midsole for comfort
- Stud and cleat-compatible 4.5 mm Vibram® Idrogrip rubber outsole

Sizes: UK6-13

Code 19A0010

C Vibram® Idrogrip Rubber Sole **£249.00**

D 12mm Felt Sole **£229.00**

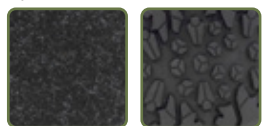

Felt sole

Vibram® Idrogrip sole

Large and small sizes available by special order. Please visit www.sportfish.co.uk or call 01544 327 111 for more information.

Constructed with ultra-lightweight materials



Vibram® Idrogrip Lite rubber soles, exclusive to Simms

Simms Flyweight Access Boots

Your go-to boot if you enjoy long hikes up to hill lochs or if you simply like to cover a lot of ground during your day's fishing. These boots are designed to save as much weight as possible whilst still providing excellent grip, stability and comfort both in the water and on land. Featuring Vibram® Idrogrip Lite rubber soles, exclusive to Simms.

Key Features

- Constructed with ultra-lightweight materials
- Welded TPU overlays in high-abrasion areas for added durability
- Vibram® Idrogrip Lite soles for exceptional grip
- Compression moulded, dual-density EVA midsole for cushioning and support

Sizes: UK6 - UK13 **Colour:** Dark Stone

Code 22A0002

Vibram® Idrogrip Lite Sole **£319.00**



Simms Tributary Boots - 2023

The Simms Tributary wading boot is comfortable, rugged and durable at a great price. The whole construction of this boot, with its reinforced sole construction with ESS plates, a robust rubber toecap and corrosion-resistant hardware, provides your feet with comfort and stability keeping you upright and safe – in and beside the water.

Key Features

- Corrosion-resistant hardware offers great durability
- Rubber toecap for outstanding abrasion resistance
- Comfortable neoprene lining on the inside for easy putting on and taking off
- Reinforced sole construction with ESS plates for good durability
- Side drain holes for quick water drainage
- Available with slip-resistant rubber soles or with durable 12mm felt soles
- Both felt and rubber soles can be studded for additional grip

Sizes: UK3 - UK14 **Colour:** Basalt

Code 23A0019

E Rubber Sole **£159.99**

F Felt Sole **£159.99**

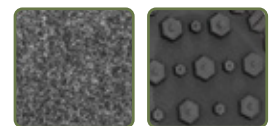

Felt sole

Rubber sole

WADING WADING BOOTS/STUDS



Made of synthetic material for minimal water absorption

A

B



Vision Koski Boots

Lightweight but solid, the Vision Koski wading boot is made from durable PVC material which doesn't absorb water, so it dries quicker and feels lighter. A very supportive wading boot with good stability and torsional stiffness. The upper of the boot is stitched to the moulded EVA midsole.

Key Features

- Made of synthetic material for minimal water absorption
- Optimised seam placement
- Comfortable neoprene lining in the ankle area
- Protected toe and heel areas
- Available with felt or Gummi™ rubber soles, both of which can be studded

Sizes: Felt: UK5-UK13 Gummi™: UK6-UK13 (Large and small sizes by special order)

Code 20A0056

A Felt **£129.99**

B Gummi™ Rubber **£159.99**

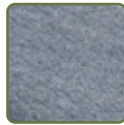

Felt sole



Gummi™ Rubber sole

C

D

Lightweight - Ideal for travel



Vision Atom Boots

The Vision Atom boot is a lightweight yet rugged traditional fabric boot which is the lightest option in Vision's range and ideal for those who like to travel. For additional durability, the Atom features tough PVC front and heel sections with a strong and comfortable EVA mid-sole. The felt sole can be studded with optional studs for even more grip.

Key Features

- Durable rigid overall design
- PVC front and heel sections
- Lightweight - ideal for travel
- Available with felt or Gummi™ rubber soles, both of which can be studded

Sizes: UK 4-12

(large and small sizes by special order)

Code 20B0023

C Felt **£109.99**

D Gummi™ Rubber **£139.99** (Sizes UK 7-12 only)

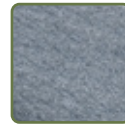

Felt sole



Gummi™ Rubber sole

WADING BOOT STUDS

Snowbee Tungsten Studs

Super-hard screw-in studs with a 4-point tungsten carbide tip for the ultimate grip on slippery rocks. Stud tool provided.

Pack of 20.

Code 16A0139

£27.99



Patagonia Traction Stud Kit

Durable steel studs with six-head bite tips with locking teeth. Supplied in a tub of 36 studs with a fitting tool.

Code F20A0343

£29.99



Simms AlumiBite Cleats

Replaceable aluminium cleats that fit with Simms' StreamTread™ soles. Sold individually or in tubs of 10.

Code 21A0119

Sold Single **£1.99**

Pack of 10 **£34.99**



Simms Wader Boot Studs

Improved to offer the ultimate traction and durability, offered in different types to perfectly match your boot sole.

E Hardbite Studs Felt

Longer screw to fit felt soled boots.

Pack of 20.

£34.99

F Hardbite Studs Vibram

Specifically designed shorter screw for Vibram soled boots.

Pack of 20.

Inc Hex Nut Driver.

£34.99

Code 30002



Guideline Tungsten Studs & Tool

Strong, durable tungsten studs suitable for both felt and rubber soles. These tungsten studs will provide great grip on all surfaces. Supplied with a convenient tool. Set of 30.

Code 20A0110

£35.99



Simms Hardbite Star Cleat Studs

Designed specifically to be used with the StreamTread sole, they slot into place between the sole lugs.

Sold Singly **£3.99**

Pack of 10 **£34.99**

Code 10150

Replacement Wader Studs

Self-lapping studs made from extremely hard steel which can be fixed into the sole with a screwdriver or drill bit.

Bag of 30 **£4.99**

Bag of 100 **£12.99**

Code 11708





Reach-through fleece-lined handwarmer pocket

Simms Women's Freestone® Waders

The women's Freestone® stockingfoot wader was designed with input from Simms' top female fishing guides and features a women's specific cut that allows for natural mobility. The durable, breathable four layer Toray® QuadraLam build handles both undergrowth and cold, wet weather. And when it comes to small details that make big a difference, the Freestone includes a large fleece-lined, reach-through handwarmer pocket for cooler weather, a secure chest pocket for essential tool storage, plus a dedicated patch to keep a selection of flies handy at all times.

Key Features

- Self-fabric gravel guard with gathered elastic bottom hem
- Back yoke design improves torso fit
- Two belt loops with 38mm nylon waist belt
- Anatomically engineered neoprene stockingfeet with anti-microbial finish

Colour: Slate

Code 23A0024 £449.00

Size	Bust	Seat/Hips	Inseam (to Floor)	UK Shoe Size
Small	35"	37"	31-32"	3.5 - 5.5
Medium	37"	39"	31-32"	5.5 - 7.5
Large	39"	41"	31-32"	6.5 - 8.5
XLarge	43"	45"	31-32"	6.5 - 8.5

Anatomically engineered neoprene stockingfeet with anti-microbial finish



Reach-through fleece-lined handwarmer pocket

Simms Women's Tributary Waders

The Simms Women's Tributary stockingfoot wader is built with proven Simms expertise and durability using a 3-layer waterproof breathable polyester fabric on the upper body and 4 layers on the lower section. Designed with a cut and fit specifically for women, it also includes a zipped storage pocket and reach-through fleece-lined handwarmer pocket.

Key Features

- Self-fabric gravel guards with gathered elastic bottom hems
- Anatomically engineered neoprene stockingfeet with antimicrobial finish
- Two belt loops with 38mm nylon waist belt

Colour: Basalt

Code 23A0023 £249.00

Size	Bust	Seat/Hips	Inseam (to Floor)	UK Shoe Size
Small	35"	37"	31-32"	3.5 - 5.5
Medium	37"	39"	31-32"	5.5 - 7.5
Medium Full	38"	40"	31-32"	5.5 - 7.5
Large	39"	41"	31-32"	6.5 - 8.5
Large Full	41"	43"	31-32"	6.5 - 8.5
XLarge	43"	45"	31-32"	6.5 - 8.5

Self-fabric gravel guards with gathered elastic bottom hems

Additional sizes are available please visit www.sportfish.co.uk or call 01544 327111 for more information.

Simms Women's Freestone® Jacket

Simms' Freestone® collection fuses high-quality materials with advanced designs that brings function, performance and value to the forefront. The Simms Women's Freestone® Jacket uses 3-layer Toray® fabric for a durable, feature-rich shell that provides waterproof, breathable protection.

Key Features

- Centre front AquaGuard® waterproof zip and zip garage at chin for next-to-skin comfort
- 2 AquaGuard® zipped chest pockets and 2 zipped handwarmer pockets with brushed tricot lining for warmth - pockets are complete with drain holes for deep wading
- 3-point adjustable storm hood
- Articulated sleeve with anti-line catch moulded cuff tab
- Shaped waist with two side zipped gussets for a comfortable and versatile fit while remaining stylish

Colour: Black

Code 23A0022

Small	Medium	Large	XLarge	Price
34-36"	36-38"	38-41"	41-44"	£329.00

AquaGuard® waterproof zip and zip garage at chin for next-to-skin comfort



3-layer Toray® fabric for a durable, feature-rich shell that provides waterproof, breathable protection



Snowbee 210D Nylon Wadermaster Waders

Snowbee's 210D Nylon Wadermaster Waders are incredibly tough, durable and hardwearing. They feature a full cut American style with outside leg seams and a single front-to-back seam to avoid rubbing. They also have a 3-in-1 chest front patch pocket with handwarmer pockets behind. Opposing buckles on the braces allow them to easily be rolled down and converted into waist waders. Cleated Sole.

Key Features

- 210D material with a soft laminated PVC lining
- Front chest pocket with handwarming pockets behind
- 2 mesh front pockets and an internal zipped pocket
- Comfortable, adjustable elasticated braces
- 2 D-rings for accessories
- Elasticated chest drawstring ensures a snug fit

Code 18A0075 £119.99



Cleated Sole



Boot size	UK6	UK7	UK8	UK9	UK10	UK11	UK12
Chest	45"	45"	46"	47"	48"	49"	50"
Inseam	32"	34"	36"	36"	36.5"	36.5"	37"
Outseam	50"	51"	53"	53"	54"	54"	55"

Other sizes available. Please visit www.sportfish.co.uk or call 01544 327 111 for more information.



Snowbee Prestige STX Breathable Bootfoot Waders

These bootfoot waders use the same breathable, lightweight, flexible and silent Soft-Touch (ST) material as Snowbee's popular stockingfoot models but feature a heavy-duty, neoprene lined PVC boot. The boots have studded felt soles for total grip in all conditions.

Key Features

- Lightweight, flexible and silent Soft-Touch (ST) material
- 6-layer breathable membrane in key areas
- Double layer knee and seat pads for added protection
- Durable Water Repellent (DWR) treatment
- Twin zipped front pockets with handwarmer pockets behind
- Comfortable, heavy-duty, elasticated braces and wading belt included
- Integrated PVC boots with studded felt soles

Code 18A0076 £339.00



Studded Felt Sole



Boot size	UK6	UK7	UK8	UK9	UK10	UK11	UK12
Chest	43"	46"	46"	48"	48"	52"	52"
Inseam	34"	36"	36"	37"	37"	38"	38"
Outseam	52"	57"	57"	59"	59"	60"	60"

Other sizes, including king fittings, available. Please visit www.sportfish.co.uk or call 01544 327 111 for more information.



Vass-Tex Nova Evo Studded Bootfoot Chest Waders

The Vass-Tex 700 Nova now boasts the addition of the reinforced 'Vass Evo Boot'. The Nova Evo range uses a quality smooth PVC outer and a soft polyester inner. The tough chunky yellow soled Evo boot offers comfort, reliability and a cleated studded sole.

Key Features

- Comfortable elasticated braces with quick release buckles
- Quad-welded seams
- Knee reinforcement
- Internal pocket and chest draw cord
- Large heel kicker
- Quality Vass Evo boot

Sizes: UK6-13

Code 11A0364 £119.99



Hard-wearing sole with added tungsten studs



Snowbee Classic Neoprene Bootfoot Waders

A quality 4mm neoprene bootfoot wader for the angler looking for performance coupled with great value for money. The wide-fitting PVC boots are fully neoprene lined for added warmth and comfort. Available with two sole options, cleated or studded felt.

Key Features

- 4mm double lined neoprene
- Double layer neoprene kneepads
- High back style with built in neoprene brace straps
- Adjustable, elasticated braces
- Opposed braces clips to help conversion to waist waders
- Front pouch pocket
- Neoprene lined PVC boots
- Cleated or studded felt soles available

C Cleated £154.99 D Studded Felt £174.99

Code 18A0098



Cleated Sole



Studded Felt Sole



Boot size	UK6	UK7	UK8	UK9	UK10	UK11	UK12
Chest	38"	40"	42"	44"	45"	46"	47"
Inseam	31"	32"	34"	35"	36"	37"	38"
Outseam	51"	53"	55"	57"	58"	59"	60"

Other sizes available including fuller body fittings. Please visit www.sportfish.co.uk or call 01544 327 111 for more information.



Le Chameau Delta EVO Thigh Waders

This wader benefits from a one piece outer, ensuring absolute impermeability. Hand crafted from 100% natural rubber to guarantee comfort and durability. Brass fillings in the sole give excellent grip. Only available in green with a soft jersey cotton lining.

Sizes: UK8-12
Code 11734 £189.99

Hand crafted from 100% natural rubber



Snowbee Granite PVC Thigh and Chest Waders

Made from a durable, heavy duty, reinforced PVC laminate with a tough, woven nylon inner lining. These waders feature a sonic welded seam technique which results in super strong and smooth seams. The boots are also made from heavy duty PVC with a deep tread cleated sole.

Available as either thigh or chest waders.

Colour: Olive Green
Sizes: UK5-13
A Thigh Waders
Code 17A0027 £54.99
B Chest Waders
Code 17A0028 £74.99

Sonic welded seams which results in super strong and smooth seams



Boots made from heavy duty PVC with a deep tread cleated sole



Vass-Tex 700 Nova Thigh Waders

Rugged PVC thigh waders with comfortable heavy duty boots. Quad-welded seams & reinforced stitching make them extremely durable. The sole comes with a deep cleated tread pattern and tungsten carbide studs.

Adult Sizes: UK6-13
Code 11A0365 £89.99
Child Sizes: UK3-5
Code 11A0366 £69.99

Comfortable heavy duty boots



Snowbee 210D Nylon Wadermaster Waders

Snowbee's 210D Nylon Wadermaster thigh waders are incredibly tough, durable and hardwearing.

Key Features

- Heavy duty, moulded PVC boots with deep cleated soles
- Elasticated webbing belt straps with adjustable buckles ensure a secure and comfortable fit

Code 18A0077 £79.99
Largest and smallest sizes are sometimes by special order.

Heavy duty, moulded PVC boots with deep cleated soles



Cleated Sole

Child Size Chart			
UK Size	3	4	5
European Size	36	37	38

Adult Size Chart								
UK Size	6	7	8	9	10	11	12	13
European Size	40	41	42	43	44	46	47	48

UK Size	5	6	7	8	9	10	11	12	13	14	15
European Size	39	40	41	42	43	44	45	46	47	48	49

WADING WELLINGTON BOOTS



Leon Ultralight Explorer Boots

An ultralight, durable, EVA moulded boot that is 65% lighter than rubber boots and will keep your feet comfortable, dry and warm even in freezing conditions. The thick cushioned soles give you great all-day comfort and support. Supplied with a removable and machine-washable warm liner.

Colour: Black
Sizes: EU 41-46 / UK 7-12

Code 20A0124 £59.99 *Thick cushioned soles give you great all-day comfort and support*



UK Size	7	8	9	10	11	12
European Size	41	42	43	44	45	46



Aigle Parcours® 2 Vario Wellington

The first anti-fatigue boot adapted to all calves. With their tri-density rubber soles, Parcours® boots offer comfort, allowing you to walk further without getting tired. The damping cushions in the heels act as return springs, reusing part of the energy used in taking a step. With their adjustable tabs and gussets, these boots fit snugly to your legs and the fitted ankles hold your feet firmly. The insole is made from absorbent foam over Softex® lined rubber and the polyester interior of the boot dries quickly.

Colours:
A Bronze **B** Khaki
Sizes: 39-48

Code F14A0507B £174.99



Le Chameau Chasseur Neoprene Full Zip Wellington

The iconic Chasseur, a handcrafted neoprene lined zip-sided wellington. The boots feature a reinforced front section for abrasion resistance and a rugged waterproof Riri Aquazip and button for fastening. Insulated with 3mm neoprene for cold weather performance, while a shock-absorbing all-terrain sole provides comfort and arch support.

Colour: Vert (Green)

Code F16A0169 £290.00
Other sizes may be available.
Please visit www.sportfish.co.uk or call 01544 327111 for more information.



EU	40	41	42	43	44	45	46	47	48
UK	6.5	7	8	9	10	10.5	11	12	12.5
Calf-cm	41	41	41	43	43	44	44	44	46



Wychwood Neoprene ¾ Boots

A well-made alternative to standard wellies, the neoprene upper provides more warmth than conventional rubber.

- ¾ length boot
- High grip sole with heavy tread
- Kick off heel bumper for ease of removal

Colour: Green
Sizes: UK7-12

Code 10151 £69.99

High grip sole with heavy tread



farlows

Farlows Boot Bag

A tough boot bag for wading boots or wellingtons up to size 12.

- Zip entry
- Grab handle
- Keeps your car boot clean

Colour: Olive Green

Code 10257 £19.99



Le Chameau Vierzonord Wellington

A premium rubber boot, lined with 2mm of neoprene to provide first rate insulation and comfort.

- Dual density sole
- Buckle and gusset for easy entry

Sizes: UK7-11 (Calf 41cm)

Code 11737 £199.99

Buckle and gusset for easy entry

Dual density sole



UK Size	7	8	9	10	10½	11
European Size	41	42	43	44	45	46

ORVIS



Seamless PU cage technology that provides superior drainage



Michelin® Outdoor Extreme rubber outsole

Orvis PRO Approach Wet Wading Shoes

The rugged Men's PRO Approach Shoes take you from wet wading to boating to hiking in comfort. Incredibly lightweight, quick drying, with trail shoe look, weight, and comfort, and wading shoe performance, stability, and durability. The strength and reduced weight come from seamless PU cage technology that provides superior drainage, as well as durability.

- Integrated, breathable Ariaprene® sock keeps debris out
- Michelin® Outdoor Extreme rubber outsole
- 43% better wet rubber traction and 25% higher abrasion resistance than the competition
- Removable 3D moulded OrthoLite® insole & single density phylon midsole
- Integrated lace hood allows laces to easily tuck away

Sizes: UK9-12

Code 22B0046 £178.99

patagonia

Waterproof treated full-grain leather



Perforated quick drain holes

Patagonia River Salt Wading Boots

Hand-built by Danner in the USA this is the best wet wading or flats fishing boot that your money can buy.

Sizes: UK8-11 (For more information please see page 111)

Code F20A0126 £380.00

Snowbee Saltwater Neoprene Gravel Guards

Designed specifically for saltwater wading, eliminating the conventional zip fastening which can be prone to jamming when wet wading on sand. The Velcro®-compatible material allows the gravel guard to wrap securely around your leg and secure in any position, completely preventing fine sand and gravel entering your wading boots. Lacing hook attaches to boots to hold them in place.

Code 15A0317 £32.99



SIMMS



Non-absorbing, comfortable foam lining

Rubber sole provides grip when wet

Simms Flats Sneaker

The go-to choice for stalking fish on saltwater flats combining the durability and support of a wading boot with the lightweight comfort of a trainer. The non-marking rubber sole provides great grip both on the boat and in the water.

- Durable, saltwater-friendly materials
- Non-absorbing, comfortable foam lining
- Rubber sole provides grip when wet
- Removable Right Angle® footbed ensures a secure and comfortable fit

Sizes: UK6-13

Code 18B0085 £199.99



Perforated neoprene upper with rubber overlays for additional durability

Simms Zipit II Bootie

The Simms Zipit II Bootie is the ultimate easy on/off saltwater wet wading shoe. Goes on and off quickly and easily thanks to the large gusseted opening and YKK® corrosion-resistant zips. Designed to be worn barefoot or with a light liner sock.

- Perforated neoprene upper with rubber overlays for additional durability
- Durable rubber outsole & full length Bi-Fit™ lasting board for puncture resistance

Colour: Grey Sizes: UK7-12

Code 13A0078 £129.99

Simms Guide Wet Wading Socks

Simms Guide Wet Wading Socks are constructed from quick-drying hydrophobic yarns that make them the ultimate socks to wear together with saltwater boots when exploring the shoreline or wading tropical flats. The Right Angle® arch support enhances comfort, cushioning and anti-abrasion performance when wet wading.

Colour: Boulder

Sizes: Medium (5-8), Large (8-11), XLarge (11+)

Code 17B0014 £34.99





Simms Merino Midweight Hiker Socks

Slightly heavier, mid-calf height, crew socks made from soft premium merino wool - great for wicking moisture and keeping odour away. They feature additional cushioning in the high-impact areas. 67% merino wool, 31 nylon, 2% Lycra®.

Colour: Steel Grey
Sizes: Medium UK6-8, Large UK8-11, XLarge UK11+

Code 20B0025 £32.99



Simms Merino Midweight OTC Socks

Over-the-calf socks made from mid-weight merino wool which provides excellent moisture management and anti-microbial protection and keeps your feet warm and comfortable in a wide range of temperatures. They also feature additional cushioning in the high-impact areas. 66% merino wool, 31% nylon, 3% Lycra®.

Colour: Carbon
Sizes: Medium UK6-8, Large UK8-11, XLarge UK11+

Code 20B0026 £39.99



Simms Merino Thermal OTC Socks

Warm, heavyweight, hardworking over-the-calf socks made from premium merino wool for moisture management & odour prevention. They also feature a reinforced midfoot support with a reinforced heel and toe. Perfect with wellington boots or under waders on cold days. 81% merino wool, 18% nylon, 1% Lycra®.

Colour: Carbon
Sizes: Medium UK6-8, Large UK8-11, XLarge UK11+

Code 20B0027 £45.99



Schöffel Technical Fly-Fishing Socks

The ultimate comfort, support and cushioning for your feet. The antimicrobial fabric manages moisture and prevents odours, while the 37% acrylic, 36% wool, 27% nylon construction ensures comfort whatever the temperature range. Finished with a faux leg rib to prevent the sock from rolling down.

Colour: Loden
Sizes: (4-7) or (7-11)

Code 21A0055 £24.99



HORIZON

WE'VE GOT YOUR FEET COVERED



Horizon Field Sport Technical Turn-over-Top Socks

A traditional shooting sock updated for the 21st century, offering supreme comfort for long days in the field, with a Primaloft® Silver and merino wool blend for the perfect balance of warmth and moisture-wicking performance. Extra support in key areas also provides added comfort and durability over time.

Colours: **A** Olive/Mustard

B Burgundy/Mustard

Sizes: M (UK6-8½) or L (UK9-11½)

Code F19A0075 £44.99



Horizon - Tactical Merino Micro Crew Socks

Made from extra-fine merino wool this comfortable and incredibly durable sock has a short ribbed leg and special grip sections for subtle support as well as a flat linked toe seam to prevent any rubbing which may cause blisters.

Colour: Anthracite/Burgundy
Sizes: M (UK6-8½) or L (UK9-11½)

Code 18A0080 £21.99



Horizon - Tactical Merino Over-Calf Socks

The tightly knitted, extra-fine merino wool provides warmth, comfort and durability. The classic ribbed leg ensures the socks don't fall down. Grip sections and Lycra maintain a perfect fit and a flat linked toe seam prevents any abrasion.

Colour: Olive/Black
Sizes: M (UK6-8½) or L (UK9-11½)

Code 18A0078 £34.99



Horizon - Performance Extreme Primaloft® / Merino Over-Calf Socks

This extreme over-calf sock is the best cold weather sock that money can buy. The Primaloft® Silver merino wool blend offers an antibacterial finish, enhanced warmth, superior comfort and unrivalled performance. Added Isofil polypropylene wicks away moisture and hard-wearing cordura improves the durability.

Suitable for sub-zero temperatures down to -40°.

Colour: Charcoal/Orange
Sizes: M (UK6-8½) or L (UK9-11½)

Code 18A0081 £44.99



Horizon Field Sport Gamekeeper Socks

Heavyweight mid-calf length socks designed for use with all work boots, featuring fully cushioned merino wool for comfort and moisture-wicking quick-dry performance. Finished with hard-wearing Cordura on the toes, heel, and achilles for long-lasting durability and service in the field.

Colour: Olive
Sizes: UK 8-12

Code F19A0305 £24.99



Horizon - Tactical Merino Boot Socks

The full loop-pile construction of this merino boot sock gives the feeling that your feet are floating on air. A non-restrictive welt, fine toe seam and specially designed grip add to the all-over comfort, while the Lycra content maintains a sure fit wash after wash.

Colour: Olive/Black
Sizes: M (UK6-8½) or L (UK9-11½)

Code 18A0079 £26.99



Horizon - Heritage Merino Over-Calf Socks (Twin Pack)

A great value twin pack of traditional merino over-calf socks that are warm, hard-wearing and offer a superb fit. Elasticated grip sections, a non-restrictive in-turned welt and a fine recessed toe seam enhance the fit and the comfort and the Lycra helps maintain the shape.

Colour: Olive/Orange
Sizes: One Size UK 8-12

Code 18A0082 £37.99 (Twin Pack - Two Pairs)



SealSkinz Walking Thin - Mid Length Socks

SealSkinz lightest waterproof socks are ideal for warm wet days. They are constructed with their proprietary stretchdry waterproof, breathable and windproof technology.

Colour: Grey/Black
Sizes: M (6-8), L (10-12)

Code 17A0511 £37.99



WADING BOOT ACCESSORIES



Simms Wading Boot Replacement Laces
 High quality denier nylon 74" laces for increased lifespan. Feeds easily through boot hooks and eyelets.
Colours: **A** Black **B** Pewter **C** Orange
Code 18A0007 £14.99 pair



Snowbee Boot Rack
 A simple solution for storing and drying waders or wellies. Stores two pairs at a time. Rugged polypropylene construction. Screws to garage or tackle room wall with screws provided.
Code 18A0097 £19.99



Vision Wading Boot Laces
 Quality, rot-proof, nylon wading boot laces.
Colour: Olive
Code 23A0043 £6.99 pair



Textreme Power Sox
 Virtually indestructible wading boot socks that make it easier to slide into wading boots, they also protect the neoprene feet on your waders. Stretchy, one size fits all.
Code 23A0101 £22.99 pair



WADER AND WATERPROOF REPAIR AND CARE

Grangers Performance Wash Concentrate
 A gentle wash-in cleaner for all outdoor clothing that protects your apparel's water-repellent finish. It can be used in your washing machine or when hand washing to remove dirt and to neutralise odours. Now in a recycled bottle or 1L pouch.
Size: 300ml bottle **£7.29**
 1L Pouch **£13.49**
Code 21A0078



Aquasure
 The most popular way to repair waders. Clear supertough flexible polyurethane in a tube. Repairs any type of wader. 28g tube.
Code 11755 £9.49



Aquasure Twin Pack
 Handy pack of twin travel sized tubes of clear Aquasure polyurethane adhesive. 2 x 7g tubes.
Code 13A0195 £9.99



Stormsure Clear Adhesive 3 x 5g
 The original waterproof, flexible, clear adhesive and sealant for all types of repair to waders or boots and just about anything else you can think of. 3 x 5g tubes.
Code 18B0046 £9.99

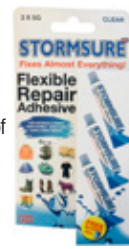

Gulf Aquafix
 A waterproof sealant for wader leaks and other repairs. Cures in 12-24 hours to a tough, flexible rubberised finish. 15g tube.
Code 23A0049 £12.99



Grangers Clothing Repel
 A treatment which adds durable water repellency to your garments while ensuring breathability. Suitable to use on hardshell and softshell garments including GORE-TEX® membranes. Use in your washing machine or when hand washing.
Sizes: 300ml bottle **£10.49**
 1L Pouch **£20.49**
Code 21A0079



REVIVEX® Pump Spray 500ml
 REVIVEX® is the best water-repellent available. Recommended for all GORE-TEX® and WINDSTOPPER® garments and all other types of breathable laminates and synthetic fabrics.
Code 21A0093 £24.99



Nikwax TX-Direct Spray-On
 Spray-on waterproofing for waterproofs and waders.
Size: 500ml Spray on bottle
Code 15A0029 £11.49



Grangers Wash + Repel Clothing 2 in 1
 Washing and repellency combined in a single treatment via your washing machine or when hand washing.
Sizes: 300ml bottle **£11.99**
 1L Pouch **£21.49**
Code 21A0080



Nikwax TX-Direct Wash-In
 Wash-in waterproofing for wet weather clothing and waders.
Size: 300ml bottle
Code 15A0030 £8.79



Grangers Performance Repel Plus
 A simple-to-use, environmentally friendly, spray-on durable water repellency. Always wash garment first as Grangers recommend applying waterproofing treatment to clean damp clothing.
Size: 275ml spray bottle
Code 21A0081 £10.49



Nikwax Tech Wash
 A non-detergent cleaner for waterproof clothing which safely revitalises the breathability and water-repellency of the garments. Use before re-proofing.
Size: 300ml bottle
Code 15A0028 £5.29



Stormsure Stormproof DWR Spray 250ml
 Turns any fabric waterproof, by applying a water-based, air-dry, Durable Water Repellent (DWR) coating to the surface. Ideal for re-proofing any garment. 250ml spray bottle
Code 18B0048 £11.99



Stormsure Boot & Wader Repair Kit
 A handy repair kit containing 2 x 75mm patches and 1 x 5ml tube of adhesive to fix leaks in waders and boots.
Code 18B0049 £8.99



Snowbee Suncure Wader Repair
 A clear, flexible material that cures under UV light (sunlight) in as little as 15 seconds. Suitable for all types of waders. 15ml tube.
Code 22A0097 £10.99



UV Wader Repair
 Clear, flexible polyurethane which cures in seconds when exposed to daylight. Suitable for all types of wader repairs. Please see page 78 for the Loon UV light.
Code 11756 £9.99



Simms Boa® M2 Field Repair Kit
 Replacement lacing system for Simms Boa® wading boots. Includes knob and wire lace.
Sizes: S/M (UK6-9) or L/XL (UK10-13)
Code 12A0021 £19.99



Snowbee Wading Boot Felt Sole Kit
 Specifically designed for replacing felt soles on wading boots. The one piece felt sole is oversized to fit any size boot up to size 14 and is simply cut down to fit smaller sizes. Includes adhesive, replacement felt soles and full instructions.
Code 70112 £49.99

WADING STAFFS



Snowbee Prestige Folding Wading Staff - Green

A strong, lightweight, 4-piece lockable aluminium wading staff. Comfortable rubber handle grip with an adjustable wrist strap and a removable elastic lanyard. Both optional rubber cap and hardened steel tips are supplied. All packs into a neat neoprene belt pouch. Folded 38cm. Extended 140cm. Weight 340g.

Code 20A0059 £69.99

Guideline Foldable Carbon Wading Staff

Practical and handy, lightweight, carbon 4-piece wading staff that extends automatically when taken out of the pouch. The replaceable inner cord locks the staff in extended mode and secures the joints. Extended 147cm. Folded 36cm. Weight 210g.

Code 20A0053 £109.99



Vision Folding Wading Staff

A reliable 7-section aluminium folding wading staff with a comfortable non-slip EVA handle. Supplied with convenient sheath with a belt loop and lanyard.

Code 25371 £79.99



Scottie Split Cane Wading Staff

A beautiful UK handmade split-cane, 56ins wading staff with a comfortable shaped handle and a weighted rubber-tipped end to provide a light yet robust staff for wading. 56in/290g.

Code 14A0616 £189.99



Simms Pro Wading Staff

A strong, 3-section, hybrid carbon fibre and aluminium wading staff with a comfortable cork/EVA handle. Easy one-handed deployment mechanism makes staff ready in seconds. Supplied with a built-in wrist strap, retractor and secure moulded sheath.

Extended length is adjustable between 120-140cm. Folded length 40cm.

Weight: 260g

Code 22B0032 £229.00



Snowbee Telescopic Wading Staff with Depth Markers

A tough anodised aluminium wading staff with depth markers up to 140cm. Useful to know how deep your next step might be and when you want to measure your salmon. Telescopes down to a maximum 160cm to a convenient 86cm for travelling. The twist & lock mechanism allows it to adjust securely to any length. Supplied with a comfortable rubberised handle, an adjustable lanyard & clip and a weighted bottom.

Code 17A0083 £44.99



Sharpes Spey Staff

Sharpes Spey wading staff is one of the best available. With a one piece shaft and heavily weighted bottom. This staff will keep you safe in the toughest of wading situations. Comes complete with its own lanyard. 140cm long. Weight 40oz.

Code 11652 £57.99

Patagonia Wading Staff

A strong and compact, 4-piece carbon-wrapped aluminium wading staff with a comfortable ergonomic foam handle and safety strap. Supplied with a convenient clip-on retractor and a quick-drying, mesh carrying bag.

Folded 46cm, Extended up to 55cm. Weight 335g.

Code F21A0139 £149.99



Quick-drying mesh carrying bag

WADING STAFF ACCESSORIES



Hammerhead Wading Staff Retractor

Keeps your wading staff to hand at your side, so you can grab it when you most need it.

Code 11648 £26.99



Snowbee HD Wading Staff / Net Zinger

A heavy-duty zinger with a convenient carabiner clip and a long 70cm plastic covered wire cord.

Code 22A0098 £18.99

WADING SOCKS AND GRAVEL GUARDS

Full Velcro® wrap for a super secure fit

Simms Neoprene Gravel Guards

Stops sand from getting into your boots. They also work effectively in saltwater conditions. Full Velcro® wrap for a super secure fit. Calf-high length. High-quality 3mm neoprene. Strong hooks fasten securely to all wading boots.

Code 11707 £39.99



Heavy-duty zip, plus Velcro® flap fastening

Snowbee Neoprene Guards

3mm double lined neoprene. Heavy-duty zip, plus Velcro® flap fastening. Worn over the top of wading boots, to prevent gravel and sand entering the boots.

Code 13A0083 £27.99



Simms Guide Guard Socks

Left & right socks made from comfortable 3.5mm neoprene with durable textured nylon. Features built-in gravel guards and boot hooks.

Sizes: S (6-7), M (7-9), L (9-11), XL (11-12)

Colour: Pewter

Code 18A0012 £49.99 Pair



Built-in gravel guards and boot hooks

Simms Neoprene Wading Socks

Anatomical fit with 2.5mm airprene underfoot and neoprene jersey upper for added comfort.

Sizes: S (5-7), M (7-9), L (9-11), XL (11-13)

Colour: Cinder

Code 19A0054 £29.99 Pair



WADING BAGS

Wychwood Wader Bag

An innovative and unique hanging bag which solves the problem of looking after your waders when wet. Simply put them in the bag straight from the river, and then hang the un-folded bag in the garage to let them dry. Fold it up and you're ready to go again.

- Hangable bag to aid drying and provide correct storage of waders
- Easily transportable, folding design
- Unique no fuss Drop'N'Dry system

Colour: Olive Green
Code 19A0042
£79.99



Snowbee Chest Wader/Boot Bag

A ventilated wader/boot bag with a mesh panel in the lid with a roll-out waterproof changing mat. The internal dividing flap separates wet waders and muddy boots from your dry clothes.

Size: 40 x 40 x 18cm
Colour: 2-Tone Sage Green
Code 18B0041 **£49.99**



Greys Fish/Wet Wader Bag

A durable, leak-proof bag in bag system which allows you to carry either your wet gear or fish. The inner PVC bag folds down with a Velcro® closure and then the outer bag zips shut. Supplied with comfortable handles and shoulder strap.

Size: 60 x 56 x 5cm **Colour:** Grey and Red
Code 17B0034 **£39.99**

Roll-out changing mat



Fishpond Burrrito Wader Bag

The perfect solution for transporting wet waders and boots away from the water before drying them out at home. Featuring a roll-out changing mat to protect neoprene stocking feet from objects on the ground, webbing shoulder strap and a drawstring closure, ensuring that all your wet gear is contained inside. No more wet mess in the car!

Size: 76 x 48 x 10cm
Capacity: 40L
Code 21A0070 **£64.99**

Farlows Boot Bag

A tough boot bag for wading boots or wellingtons up to size 12.

- Zip entry
- Grab handle
- Keeps your car boot clean

Colour: Olive Green
Code 10257
£19.99



Simms Taco Wader Bag

A clever but simple bag doubles as a changing mat. Opens into a circular mat, and you simply fold it around your waders and boots once you are out of them, and zip it up. It is large enough to hold up to two stocking-foot waders & two pairs of wading boots. The mesh vents help prevent mould & mildew. A YKK® zipper comes as standard. Made from PU-coated 600 denier ballistic nylon shell fabric.

Colours: **A** Anvil **B** Regiment Camo **C** Simms Orange
Code 16B0056 **£49.99**

WADING BELTS



Simms Back Magic Wading Belt

Protect your back when wading with this belt designed by orthopaedic doctors to minimise lower back pain. Adjustable compression with a single tension handle and easy fit velcro closure.

Sizes: S/M 29-34" or L/XL 35-41"
Code 19A0133 **£119.99**



Simms Neoprene Wader Belt

Comfortable 2" wide neoprene belt with Velcro® size adjustment and a quick action side release buckle.

Sizes: Adjustable from 28-46"
Code 16A0031 **£39.99**



Patagonia Wading Support Belt

Provides a sturdy, moulded back support for comfortable, all-day wading. Integrates into Patagonia waders and features a generous net sleeve and a durable quick-release buckle.

Sizes: S/M (up to 34") or L/XL (up to 40")
Code F20A0090 **£89.99**



Vision Wading Belt

A durable and comfortable elastic wading belt with a quick-release YKK buckle.

Code 19A0053 **£16.99**



Fishpond South Fork Wading Belt

Features a net-slot together with loads of attachment points for accessories. Padded foam and a sturdy buckle ensures comfort and a great fit.

Code 22A0069 **£54.99**



Simms Flyweight Tech Utility Belt Tan

Adjustable, ergonomic and comfortable utility belt and lumbar support which delivers a range of customisable carry solutions for active anglers. Compatible with all HEXGRID® Flyweight Pods and Accessories.

Code 21A0034 **£49.99**



Schöffel Salar II Wading Jacket

Designed specifically for the most discerning and uncompromising fly fisherman, this waterproof, breathable and hard-wearing jacket is made using a GORE-TEX® 3-layer ripstop laminate. The jacket features numerous useful pockets, a peaked packaway hood, and comfortable adjustable watertight cuffs.

Key Features

- 3-point, adjustable packaway hood
- Internal water resistant zipped pocket with a clear face for mobile phone usage
- 2 zipped fleece-lined handwarmer pockets, 2 large top-access chest pockets, an internal zipped security pocket and a large zipped rear game pocket
- Hypalon port and D-ring for handy tool and zinger attachment
- Built-in sunglasses cleaner
- Adjustable drawcord on bottom hem
- Quality YKK® water resistant zips
- Rear D-ring for net
- Velcro® fly patch pad
- Wading belt loops

Colours: **A** Graphite **B** Forest Green

Code **F23A0108**



Size	Size	Size	Size	Size	Size	Size	Price
36"	38"	40"	42"	44"	46"	48"	£599.00



Schöffel Mayfly Fishing Jacket

An extremely comfortable lightweight and highly breathable jacket made with Toray Dermizax NX 3-layer ripstop fabric with a hard-wearing nylon face that offers outstanding performance and weather protection. Highly versatile, this jacket is ideal for the active and mobile angler looking for a quality packable jacket.

Key Features

- 3-point, adjustable packaway storm hood with peak
- Internal water-resistant zipped pocket with a clear face for mobile phone usage
- 2 large top-access chest pockets and 2 zipped fleece-lined handwarmer pockets
- Quality YKK® water resistant zips
- Adjustable cuffs
- Hypalon port and D-ring for handy tool and zinger attachment
- Rear D-ring for net
- Velcro® fly patch pad
- Adjustable drawcord on bottom hem

Colour: River Green

Code **21A0051**



Size	Size	Size	Size	Size	Size	Size	Price
36"	38"	40"	42"	44"	46"	48"	£429.00



Schöffel Annan II Technical 1/4 Zip Fleece

A comfortable and technical super-soft stretchy fishing 1/4 zip fleece, perfect to be worn under the Schöffel Salar or Mayfly fishing jackets.

Key Features

- Large, zipped chest pocket
- Highly breathable, quick drying and superb moisture wicking technostretch fabric
- Quality YKK® quarter zip

Colours: **C** Graphite **D** River Green

Code **F23A0109**

Size	Size	Size	Size	Size	Size	Size	Size	Price
36"	38"	40"	42"	44"	46"	48"	50"	£159.99



Schöffel Thurso Down Jacket

A lightweight, down insulated, hooded jacket that's also packable and durable. It uses a water-repellent, windproof, WR PFC-free 100% nylon fabric and ethically sourced down filling (90% down, 10% feathers).

Key Features

- Tailored fit, with adjustable hood with adjustable elasticated draw chords and stoppers
- Burnt orange contrast lining, branding, zips and trims
- One-way YKK front zip with Schöffel-branded zip pull
- Elasticated internal cuffs
- Thermal conductive fibre to regulate body temperature
- Machine washable

Colour: Graphite

Code F23A0110

Size	Size	Size	Size	Size	Size	Size	Price
36"	38"	40"	42"	44"	46"	48"	£270.00

(Small and large sizes by special order)



Thermal conductive fibre to regulate body temperature



Machine washable

Elasticated internal cuffs



Internal security pocket



Machine washable with a PFC-free water-repellent finish

Two-way YKK front zip

Schöffel Brora Gilet

A wonderfully versatile, machine washable gilet with a PFC-free water-repellent finish. The 100g Primaloft® makes it highly breathable and offers great thermal insulation. Features multiple pockets, including two microfleece-lined handwarming ones.

Key Features

- Two-way YKK front zip
- Schöffel-branded leather zip pull
- Schöffel logo embroidery
- Schöffel-branded leather pip tab
- Two external zip security pockets
- Internal security pocket
- Chest pocket

Colour: Forest

Code F20A0134

Size	Size	Size	Size	Size	Size	Size	Price
36"	38"	40"	42"	44"	46"	48"	£179.99

(Small and large sizes by special order)



100g Primaloft® making it highly breathable and great thermal insulation



Schöffel Carron Jacket

A stylish coat ideal for town or country, with 100g Primaloft® making it highly breathable and offering great thermal insulation. It also has a PFC-free water-repellent finish and is machine washable.

Key Features

- Two-way YKK front zip
- Schöffel-branded leather zip pull
- Schöffel logo embroidery
- Schöffel-branded leather pip tab
- Two external zip security pockets
- Internal security pocket
- Chest pocket

Colour: Forest

Code F23A0111

Size	Size	Size	Size	Size	Size	Size	Price
36"	38"	40"	42"	44"	46"	48"	£220.00

(Small and large sizes by special order)





Schöffel Deveron Fishing Trousers

These super-comfortable, lightweight technical fishing trousers are designed specifically to be worn with waders but the classic chino style also looks great down the pub.

Water repellent with UPF50 sun protection

Key Features

- Water repellent with UPF50 sun protection
- Highly breathable, quick drying and superb moisture wicking, 2-way stretch fabric
- 4 pockets
- 32-inch inseam

Colour: Fawn

Code 21A0053

Highly breathable and quick drying

Superb moisture wicking and 2-way stretch fabric



Size	Size	Size	Size	Size	Size	Size	Price
30"	32"	34"	36"	38"	40"	42"	£109.99

Merino wool outer and a smooth and soft Tencel™ inner



Excellent moisture wicking from inside to out

Schöffel Base Layer Technical Fishing Crew

A super-soft, stretchy, crew neck base layer top made with merino wool combined with Tencel™. Perfect under a pair of waders for all day comfort and warmth.

Key Features

- Merino wool outer and a smooth and soft Tencel™ inner
- Perfect temperature regulation. Keeps you warm in winter and cool in summer
- Excellent moisture wicking from inside to out

Colour: Charcoal

Code 21A0057

S	M	L	XL	XXL	Price
36-38"	40-42"	42-44"	44-46"	46-48"	£79.99

A

B



C

D

Schöffel Findhorn Fishing Shirt

A classic shirt with a host of technical fishing features.

Key Features

- 100% polyester
- Lightweight and quick drying
- UPF40 sun protection
- Ventilated mesh back for comfort in all temperatures
- 2 large button-down chest pockets

Colours: **A** Dark Olive **B** Ice Grey **C** Dark Olive Check **D** Mykonos Blue Check

Code 21A0054

S	M	L	XL	XXL	XXXL	Price
36-38"	39-41"	42-45"	46-48"	49-51"	52-54"	£79.99

Schöffel Base Layer Technical Fishing Leggings

Super-soft, stretchy, base layer leggings made from merino wool combined with Tencel™. Perfect under a pair of waders for all day comfort and warmth.

Key Features

- Merino wool outer and a smooth and soft Tencel™ inner
- Perfect temperature regulation. Keeps you warm in winter and cool in summer
- Excellent moisture wicking from inside to out

Colour: Charcoal

Code 21A0058



Perfect temperature regulation. Keeps you warm in winter and cool in summer

S	M	L	XL	XXL	Price
28-30"	32-34"	36-38"	40-42"	44-46"	£69.99



Pro stretch panels for casting movement

Lightweight 3-layer GORE-TEX®

Simms G3 Guide Jacket

The iconic G3 Guide Wading Jacket perfectly blends mobility and functionality. Built with lightweight 3-layer GORE-TEX® combined with the first-ever 3-layer stretchy GORE-TEX® Pro (located in areas which require movement for casting), the upgraded version offers more comfort than ever before. With a fantastic pocket layout and a clever range of features to hold gadgets, this jacket allows you to keep all your essentials handy so you can focus on catching fish!

Key Features

- Durable, breathable, and comfortable GORE-TEX® Shell 3-layer fabric with GORE-TEX® Pro stretch panels for casting movement
- 3-point adjustable storm hood with high vis centre
- Right chest pocket with retractor docking station
- Left chest pocket with loop front patch to store flies and tethered, removable glasses cleaning cloth
- Zipped stretch interior pocket and dump mesh pocket for storing gloves or a hat

Colour: Gunmetal Code 22A0004

Small	Medium	Large	XLarge	XXLarge	Price
36-38"	39-41"	42-45"	46-48"	49-51"	£649.00



Lined handwarmer pockets

Fly drying patch and rear D-ring landing net attachment



Adjustable waist high drawcord

Simms Guide Classic Jacket

A true workhorse and loved by fishing guides all around the globe, the Simms Guide Classic Jacket is built to provide years of service in a range of challenging fishing environments. It incorporates tried-and-tested 3-layer GORE-TEX® fabric for protection from the elements and includes ample storage space for fishing gear.

Key Features

- 3-point adjustable storm hood with high collar and brim
- Fly drying patch and rear D-ring landing net attachment
- Two large chest pockets designed to carry fly boxes and an interior zipped chest pocket for essentials
- Lined handwarmer pockets
- Adjustable waist high drawcord

Colour: Carbon

Code 21A0027

Small	Medium	Large	XLarge	XXLarge	Price
36-38"	39-41"	42-45"	46-48"	49-51"	£489.00

Simms G4 Pro Jacket

Simms highest-performing jacket is cut from advanced GORE-TEX® Pro Shell 3-layer fabric and loaded with ingenious fishing details. Innovative features include a chest-mounted, flip-out fly patch with a retainer docking point and spacious rear game pockets accessed through the front handwarmer pockets. Ample storage is provided by two large zipped chest pockets; two zipped, fleece-lined handwarmer pockets; a convenient zipped sleeve stash pocket; an internal zipped security pocket and an internal drop-in pocket.

Key Features

- Sleek, streamlined snag-free profile
- 3-point adjustable storm hood
- No-catch, watertight stretch shingle cuffs
- Centre back D-ring net attachment
- Drawcord adjustable hem

Colour: Slate

Code 20A0060

Small	Medium	Large	XLarge	XXLarge	Price
36-38"	39-41"	42-45"	46-48"	49-51"	£749.00

Centre back D-ring net attachment



Drawcord adjustable hem

3-point adjustable storm hood



Simms G4 Waders
SEE PAGE 107





TORAY
Innovation by Chemistry
3-layer Toray®
waterproof
breathable fabric

Adjustable fixed hood with brim



Simms Freestone Jacket

An updated version of Simms' legendary Freestone Jacket featuring 3-layer Toray® fabric and fully taped waterproof seams to protect you from the elements, keeping you comfortable on the water all day long. Features include anti-catch internal cuff design to prevent snagging from fly lines, 2 large chest pockets for essential gear, an interior pocket, handwarmer pockets and an adjustable hood.

Key Features

- 3-layer waterproof breathable fabric
- Single point adjustable storm hood with high collar and bonded brim
- Large capacity zipped chest pockets and waist-high zipped handwarmer pockets
- Interior stretch-woven zipped chest pocket
- Articulated sleeve construction for unrestricted movement

Colours: **A** Black **B** Striker Grey

Code **21B0002**

Small	Medium	Large	XLarge	XXLarge	Price
36-38"	39-41"	42-45"	46-48"	49-51"	£339.00

Simms Flyweight Shell Jacket

Designed to be rolled up and packed away into a bag or pocket, the Simms Flyweight Shell Jacket uses GORE-TEX PACLITE® PLUS to provide total weather protection in a portable package. It is also a great option for anglers who like to travel light and make long hikes to their fishing spots. Weighing in at only 315g.

Key Features

- Adjustable fixed hood with brim
- Two zipped hand pockets and a zipped chest pocket with self-stowing pouch
- Quick clips for attaching Flyweight accessories
- Simple, stretchy cuff design
- Adjustable stretch drawcord in hem for secure fit

Colours: **C** Dark Stone **D** Storm

Code **21A0026**

Small	Medium	Large	XLarge	XXLarge	Price
36-38"	39-41"	42-45"	46-48"	49-51"	£329.00

Simms Women's Freestone® Jacket

Simms' Freestone® collection fuses high-quality materials with advanced designs that brings performance, and value to the forefront. The Simms Women's Freestone® Jacket uses 3-layer Toray® fabric for a durable, feature-rich shell that provides waterproof, breathable protection.

Key Features

- Centre front AquaGuard® waterproof zip and zip garage at chin for next-to-skin comfort
- 2 AquaGuard® zipped chest pockets and 2 zipped handwarmer pockets with brushed tricot lining for warmth - pockets are complete with drain holes for deep wading
- 3-point adjustable storm hood
- Articulated sleeve with anti-line catch moulded cuff tab
- Shaped waist with two side zipped gussets for a comfortable and versatile fit while remaining stylish

Colour: Black

Code **23A0022**

Small	Medium	Large	XLarge	Price
34-36"	36-38"	38-41"	41-44"	£329.00

AquaGuard®
waterproof
zip and zip
garage at chin
for next-to-
skin comfort



3-layer Toray®
fabric for
a durable,
feature-rich shell
that provides
waterproof,
breathable
protection



Simms Challenger Bib

Simms Challenger Bib features 2-layer Toray® fabric with fully taped seams for 100% waterproof, breathable performance. External architecture includes a YKK® VISLON® centre front zipper enclosed inside a storm flap, while an adjustable hem and adjustable suspenders ensure great fit and absolute comfort. Revive cold hands in fleece-lined pockets. Keep loose gear and pliers contained thanks to a single thigh pocket with a reinforced tool sheath.

Key Features

- Fully taped seams for 100% waterproof performance
- YKK® Vislon® CF zipper with external storm flap
- Handwarmer pockets
- Single thigh pocket with reinforced plier sheath
- 38mm adjustable braces
- Adjustable hem

Colour: Black

Code 23A0005



Handwarmer pockets

Fully taped seams for 100% waterproof performance

Small	Medium	Large	XLarge	XXLarge	Price
29-31"	32-34"	35-37"	38-41"	42-44"	£279.00

Simms Challenger Insulated Bib

The Simms Challenger Insulated Bib is 100% waterproof and breathable and lined with 300g PrimaLoft® insulation for those bitter cold wet days. The fully-taped waterproof Toray® shell fabric ensures 100% waterproof performance. The PrimaLoft® Silver insulation maintains 85% of its warmth when wet and delivers maximum warmth on the coldest days. The large centre front zip is convenient when nature calls and makes getting on and off easy.

Key Features

- Fully-taped waterproof Toray® shell
- PrimaLoft® Silver insulation in body and bib
- Centre-front zipper storm flap
- Handwarmer pockets and thigh pocket with plier sheath
- Adjustable suspenders and adjustable hem
- Built-in reinforced removable knee pads

Colour: Black

Code 20B0030



Handwarmer pockets and thigh pocket with plier sheath

Built-in reinforced removable knee pads

PrimaLoft® Silver insulation in body and bib



Small	Medium	Large	XLarge	XXLarge	Price
29-31"	32-34"	35-37"	38-41"	42-44"	£349.00



3-point adjustable storm hood with stowage in collar



Simms Challenger Jacket

Simms Challenger Jacket features 2-layer Toray® fabric with fully taped seams for 100% waterproof, breathable performance. Revive cold hands in fleece-lined pockets and dodge hard rain by ducking inside a 3-point adjustable storm hood that conveniently stows in the collar. External architecture includes a YKK® VISLON® centre front zipper with a storm flap for added protection. Finally, a dual draw-cord adjustable bottom hem customises fit, while dual kill-switch anchor points add on-the-water safety.

Key Features

- Fully taped seams for 100% waterproof performance
- 3-point adjustable storm hood with stowage in collar
- YKK® Vislon® CF zipper with external storm flap
- Dual draw-cord adjustable bottom hem with dual kill switch anchor points

Colours: **A** Black **B** Midnight Blue

Code 23A0004

Small	Medium	Large	XLarge	XXLarge	Price
36-38"	39-41"	42-44"	46-48"	49-51"	£279.00



PrimaLoft® Silver insulation in body and sleeves

Dual draw-cord adjustable bottom hem

Fully-taped waterproof Toray® shell

Simms Challenger Insulated Jacket

The Simms Challenger Insulated Jacket is 100% waterproof and breathable and lined with 300g PrimaLoft® insulation for those bitter cold wet days on the water. The fully-taped waterproof Toray® shell fabric ensures 100% waterproof performance. The PrimaLoft® Silver insulation maintains 85% of its warmth when wet and delivers maximum warmth on the coldest days.

Key Features

- Fully-taped waterproof Toray® shell
- PrimaLoft® Silver insulation in body and sleeves
- Centre-front zipped storm flap
- 3-point adjustable storm hood
- 2 zipped handwarming pockets, a chest pocket and an internal zipped pocket
- Dual draw-cord adjustable bottom hem

Colour: Black

Code 20B0029

Small	Medium	Large	XLarge	XXLarge	Price
36-38"	39-41"	42-44"	46-48"	49-51"	£349.00





Simms ProDry™ Bib

Simms ProDry™ bib is made from the same 3-layer GORE-TEX® PRO Shell as the ProDry™ jacket. These will keep you dry and comfortable all day either in a boat or on the bank. Two large, top-load thigh pockets with plier sleeves and the two cargo, fleece lined handwarmer pockets keep your essentials close to hand and your valuables safe. The adjustable bottom hem together with the full-length, 2-way leg zips make this bib quick and easy to take on and off, even over boots.

Key Features

- 4 storage pockets: 2 top-load thigh & 2 micro-fleece lined handwarmer chest pockets
- Full length, 2-way centre-front zip
- Adjustable lower leg hem
- 2-way, full-length leg zips help easy on and off
- Comfortable, adjustable, padded elastic shoulder braces and stretch back panel provide all-day comfort

Colour: Carbon

Code 20B0034



3 storage pockets: 2 thigh pockets & a zipped chest

2-way, full-length leg zips help easy on and off

Small	Medium	Large	XLarge	XXLarge	Price
29-31"	32-34"	35-37"	38-41"	42-44"	£749.00

Simms Waypoints® Trousers

Lightweight, breathable and 100% waterproof over-trousers which can be rolled up and packed into your tackle bag, ready to be quickly put on when bad weather rolls in.

Key Features

- 2.5-layer waterproof breathable nylon with DWR rain protection
- Articulated knee seams for greater range of motion
- Stretch waistband with zipper fly, featuring a D-ring for boat engine kill switches
- Side access zips to reach through to your trouser pockets
- Rolls into elastic loop for packable storage

Colour: Slate

Code 21A0028

Stretch waistband with zipper fly, featuring a D-ring for boat engine kill switches



Rolls into elastic loop for packable storage

2.5-layer waterproof breathable nylon with DWR rain protection

Small	Medium	Large	XLarge	XXLarge	Price
29-31"	32-34"	35-37"	38-41"	42-44"	£159.99



Tuck-away, 3-point adjustable hood

Dry Cuff™ design locks water out of the sleeve

Simms ProDry™ Jacket

Simms ProDry™ jacket features 3-layer GORE-TEX® PRO shell for total waterproof reliability in any conditions. The pockets include 2 large zipped chest, 2 zipped handwarmers and an internal zipped security pocket. Together the oversized collar, the Dry Cuffs™ and the tuck-away, 3-point adjustable storm hood keep the wettest weather at bay. Two separate, adjustable, elastic hem cords help achieve a great fit and comfort.

Key Features

- High collar to protect from elements
- Tuck-away, 3-point adjustable hood keeps water out and is designed to wear with a cap
- Dry Cuff™ design locks water out of the sleeve
- Elastic hem cords help achieve a great fit and comfort

Colour: Carbon

Code 20B0033

Small	Medium	Large	XLarge	XXLarge	Price
36-38"	39-41"	42-45"	46-48"	49-51"	£749.00



3 point adjustable hood



B



Simms Waypoints® Rain Jacket

The Simms Waypoints® is a packable waterproof, breathable rain jacket made from 50 denier, 2.5-layer Toray fabric with a durable water repellent (DWR) coating. Features include an ultralight build, where the jacket stuffs into itself for convenient stowage via the zipped left-hand pocket. Anti-catch moulded cuffs eliminate fly line snags and a trusted YKK® Vislon® centre zip.

Key Features

- 100% seam taped, waterproof & breathable protection
- YKK® water resistant zips
- 3 point adjustable hood
- 2 zipped hand pockets
- Packable stow pocket inside left hand pocket
- No-catch, moulded cuff tabs

Colours: **A** Neptune **B** Slate

Code 23A0003

Small	Medium	Large	XLarge	XXLarge	Price
36-38"	39-41"	42-45"	46-48"	49-51"	£199.99

patagonia[®]

Integrated hood with single-pull adjustment

Reverse StretchCoat cuffs to keep arms dry



Patagonia SST Jacket

A fishing jacket for wading that's waterproof, rugged, lightweight and breathable. Made from Patagonia's 100% recycled H2No[®] Performance Standard Shell with a DWR finish. The iconic SST features two bellowed, waterproof chest pockets with a drop-in tippet pocket, a zipped stash pocket and tool docks, a large back stash pocket and two zipped handwarmer pockets. The SST is cut high for deep wading and offers double belt loops for extra wading security.

Key Features

- Integrated hood with single-pull adjustment
- Waterproof YKK[®] AquaGuard[®] Vislon[®] main zip
- Reverse StretchCoat cuffs to keep arms dry
- Beastie D-ring on the back

Colour: Smolder Blue

Code F20A0094

Small	Medium	Large	XLarge	XXLarge	Price
35-37"	38-40"	42-44"	46-48"	50-52"	£350.00

Comfortable zip garage at chin

A



NEW COLOUR

B



Patagonia Nano Puff™ Jacket

Windproof and water-resistant, the Nano Puff™ Jacket is made with warm, incredibly lightweight, highly packable 60-g PrimaLoft[®] Gold insulation. Ideal as outerwear or as an insulating layer. PrimaLoft[®] Gold is the most thermally efficient synthetic insulation available and has excellent warmth-to-weight ratio and maintains 96% of warmth, even when wet.

Key Features

- Centre zip with an interior storm flap and a comfortable zip garage at chin
- Two zipped handwarmer pockets and an internal zipped chest pocket
- Internal chest pocket doubles as a packable stuff sack
- Drawcord-adjustable drop-tail hem seals in warmth

Colours: **A** Black **B** Hemlock Green

Code F20A0106

Small	Medium	Large	XLarge	Price
35-37"	38-40"	42-44"	46-48"	£189.99



Patagonia Insulator Soft Shell Trousers

These versatile, water-resistant, insulated soft-shell trousers provide stretch, warmth and windproof protection for fishing in cold conditions. Tough, 3-layer stretch-woven shell is water-resistant and lined with a windproof laminate and soft grid-fleece insulation.

Key Features

- Two front drop-in pockets
- One rear zipped security pocket
- Elasticised waistband for comfortable fit
- Adjustable hook-and-loop closure at ankle cuffs
- Fair Trade Certified™ sewn

Colour: Noble Grey

Code F22A0253

Small	Medium	Large	XLarge	Price
29-30"	31-33"	34-36"	38-40"	£159.99



Elasticised waistband for comfortable fit

Adjustable hook-and-loop closure at ankle cuffs

Patagonia R2 TechFace Trousers

Delivering breathable, water-shedding warmth and angler-focused details, these tough, versatile pants are perfect for cold-weather/cold-water layering or even on their own.

Key Features

- Warm, high-loft double-weave fabric is soft, stretchy and lightweight and treated with a durable water repellent finish
- Two zipped thigh pockets plus an accessory loop on right waistband
- Reinforced stress points and overlays on thighs and seat for durability
- Wader-friendly non-bulky cuffs fit easily over or under socks for a snug fit under waders
- Fair Trade Certified™ sewn

Colour: Forge Grey

Code F23A0154

Small	Medium	Large	XLarge	Price
29-30"	31-33"	34-36"	38-40"	£139.99



NEW

Two zipped thigh pockets plus an accessory loop on right waistband

Wader-friendly non-bulky cuffs

CLOTHING VISION WADING JACKETS



Waterproof and breathable F4 fabric



Fully adjustable hood and large fleece-lined collar

Curved sleeves with incut cuffs

Vision Pupa Jacket

The Vision Pupa Jacket is built around a durable, 3-layer F4 fabric with a tricot lining. This jacket, whilst fully waterproof even in the heaviest rain, dries quickly and breathes well. Ample internal storage is provided by the large barrel chest pockets, the two handwarmer pockets, the internal security pocket and the handy accessory holders and tool tunnels.

Key Features

- Waterproof and breathable F4 fabric
- YKK® AquaGuard® Vislon® main zip
- Curved sleeves with incut cuffs
- 2-zipped water-resistant chest pockets with D-rings inside
- 2-hand warmer pockets and an internal chest pocket
- Fully adjustable hood and large fleece-lined collar
- Snag-free Velcro® wrist cuffs
- Adjustable drawcord hem

Colour: Rusty Orange

Code 22A0076

Small	Medium	Large	XLarge	XXLarge	Price
34-37"	38-41"	42-45"	46-49"	50-53"	£329.00

“Fully waterproof even in the heaviest rain, dries quickly and breathes well”

Waterproof and breathable three-layer F3.5 fabric



Large adjustable hood

Two large chest pockets and soft lined handwarmer pockets

Vision Vector Wading Jacket

The Vector Jacket is a waterproof, breathable wading jacket made from Vision's three-layer F3.5 fabric. A great value jacket with great features.

Key Features

- Waterproof & breathable three-layer F3.5 fabric
- High quality YKK® zips
- Two large chest pockets and soft lined handwarmer pockets
- Four accessory loops
- One secure zipped internal chest pocket
- Large adjustable hood

Colour: Military Green

Code 19A0056

Small	Medium	Large	XLarge	XXLarge	Price
34-37"	38-41"	42-45"	46-49"	50-53"	£219.00

Adjustable hood

Waterproof and breathable

Adjustable cuffs and hem



Large main chest pockets

FROM £139.99

Vision Atom Jacket

The Atom is a great value all-round fishing jacket, featuring a waterproof and breathable soft outer fabric with a mesh inner lining for comfort. Spacious chest pockets are built to hold all your essentials, and a small zip-up pocket can hold valuable items.

Key Features

- Waterproof and breathable
- Adjustable hood
- Large main chest pockets
- Adjustable cuffs and hem

Colour: Steel Blue

Code 21A0071

Small	Medium	Large	XLarge	Price
34-37"	38-41"	42-45"	46-49"	£139.99



FROM
£219.00

Adjustable, integral hood rolls neatly into the collar

3/4 length makes it ideal for use over thigh waders

Snowbee Prestige² Breathable 3/4 Length Fishing Jacket

Designed using Snowbee's most trustworthy Vapour-Tec® breathable material, providing a performance second to none. This 3/4 length jacket has simple clean lines as well as having specialist features designed for anglers and shooters. Offering complete protection, whether worn over thigh waders on the local reservoir or simply out walking the dog.

Key Features

- 3/4 length makes it ideal for use over thigh waders
- Two fleece-lined handwarmer pockets
- Two front bellows pockets for fly boxes or cartridges
- 2-way front zip with double storm flap and two key/phone pockets beneath
- Internal, adjustable draw-cord around the waist for a snug fit.
- Adjustable, integral hood rolls neatly into the collar

Colour: Dark Green

Code 20A0068

Small	Medium	Large	XLarge	XXLarge	Price
36-38"	38-40"	42-44"	46-48"	50-52"	£219.00



Two fleece-lined handwarmer pockets

Two front bellows pockets for fly boxes or cartridges

Large zipped rear pocket with strong D-ring on back for landing nets etc

Fabric lined for extra warmth and style



Adjustable waterproof neoprene cuffs with Velcro® straps

Snowbee Prestige² Wading Jacket

This jacket features top quality Vapour-Tec®, breathable, waterproof material for performance and total reliability. Slightly longer than other models it can be worn as a wading jacket or in a boat with over-trousers to keep you dry. The 3-panel, adjustable hood rolls away into the collar.

Key Features

- Tough front zip and double front storm flaps and easy-access pockets
- Adjustable waterproof neoprene cuffs with Velcro® straps
- Two large front bellows pockets with handwarmer pockets behind
- Large zipped rear pocket with strong D-ring on back for landing nets etc

Colour: Dark Green

Code 18A0083

Small	Medium	Large	XLarge	XXLarge	Price
36-38"	38-40"	42-44"	46-48"	50-52"	£199.99

Snowbee Prestige² Over Trousers

Snowbee Prestige over-trousers are ideal for boat and reservoir fishing with their high waist, high back and adjustable braces. The full length front fly will be appreciated by any angler who has fished all day in the rain; its inner waterproof gusset ensures a waterproof zip even when sitting in a boat. Reinforced nylon knee and seat pads for extra wear and protection.

Key Features

- Fully adjustable elasticated braces with quick release clips
- Velcro® side gussets offering up to 12" of adjustment on the waist
- Zipped waterproof ankle gussets for easy on/off over boots or waders
- Bellows cargo pocket, zipped thigh pocket, and two large, zipped hip pockets
- Articulated knees for freedom of movement

Colour: Dark Green

Code 18A0084

Small	Medium	Large	XLarge	XXLarge	Price
30-32"	32-34"	36-38"	40-42"	44-46"	£199.99

Fully adjustable elasticated braces with quick release clips

Velcro® side gussets offering up to 12" of adjustment on the waist

Articulated knees for freedom of movement





Fixed hood with stretch elastic opening

Simms Flyweight Access Jacket

A technical 'soft shell' style fleece jacket that balances just the right amount of insulation with a super breathable outer fabric. This jacket is great for anglers on the move. It will keep the wind chill off you when temperatures drop, and its DWR coating will protect you from light showers. A very versatile piece to have in your fishing wardrobe.

Key Features

- Recycled micro-ripstop polyester main body fabric, combined with Polartec® Power Grid™ along sides and underarms
- Fixed hood with stretch elastic opening
- Zipped stretch mesh chest pocket and two zipped hand pockets

Colour: Black

Code 21A0072

Small	Medium	Large	XLarge	XXLarge	Price
36-38"	39-41"	42-45"	46-48"	49-51"	£199.99



Fully insulated hood

Simms Fall Run Hoody

The perfect all-season insulation jacket for use both on and off the water. This lightweight jacket has an exceptional warmth-to-weight ratio so you don't feel too bulky when layering it underneath a waterproof outer shell. Built with water repellent Primaloft® Black Eco insulation and highly compressible, it's an ideal layering piece to carry conveniently in your backpack or tackle bag. Zipped handwarmer pockets are there to cure cold hands and a zipped chest pocket provides storage for a small fly box or other essentials.

Key Features

- Primaloft® Black Eco insulation with recycled polyester shell and lining
- Fully insulated hood
- Zipped handwarmer pockets and an internal chest pocket
- Ideal layering piece for a wide range of temperatures

Colours: **C** Black **D** Dark Stone

Code 21B0003

Small	Medium	Large	XLarge	XXLarge	Price
36-38"	39-41"	42-45"	46-48"	49-51"	£149.99



Simms ExStream Hooded Jacket

A comfortable, packable hooded jacket with PrimaLoft® insulation making it super-warm but without the bulk.

Key Features

- PrimaLoft® insulation stays warm in wet environments
- Stretch fabric maximises mobility and range of motion
- Lightweight, stretchy pre-baffled fabric for ease of movement and zero snags
- Two zipped handwarmer pockets and a zipped chest pocket
- Internal mesh dump pocket that doubles as a packing stuff sack
- Oversized collar for warmth and hood with a structured brim
- Interior stretch knit cuff for comfort and sealing out the elements

Colours: **A** Black **B** Dark Stone

Code 22B0031

Medium	Large	XLarge	Price
39-41"	42-45"	46-48"	£329.00



100% recycled shell with DWR finish for water resistance

Simms Fall Run Vest

Take the chill away from your core with the lightweight and insulated Fall Run Vest, made with water repellent Primaloft® Black Eco insulation to keep your body warm on cold fishing days. Great for layering under a waterproof outer jacket as well as for casual wear.

Key Features

- Primaloft® Black Eco insulation using 60% recycled materials
- 100% recycled shell with DWR finish for water resistance
- Ideal for wearing under waders or bibs
- Zipped handwarmer pockets and an internal chest zipped pocket

Colours: **E** Black **F** Dark Stone

Code 21B0004

Small	Medium	Large	XLarge	XXLarge	Price
36-38"	39-41"	42-45"	46-48"	49-51"	£129.99



Zipped handwarmer pockets and an internal chest pocket





Soft cotton/
polyester blend



Rib-knit
side
panels,
cuffs and
hem

Sage Performance Zip Hoody

A versatile full-zip hoody made with a soft cotton/polyester blend with rib knit side panels, cuffs and hem providing excellent range of motion while casting and fishing. The perfect companion for any angler looking for a comfortable and casual performance layer.

Colour: Pepper

Code 21B0062

Medium	Large	XLarge	Price
39-41"	42-45"	46-48"	£89.99



Quality YKK®
zips throughout



Snowbee Dartmoor Fleece

A stylish fleece jacket made with the very latest 300g double-brushed, anti-pill, double Polar fleece making it super-soft and super-warm. Featuring a high collar and inner storm flap under the front zip. The two side pockets have flaps reinforced with faux leather for additional style and durability.

- Latest fleece material technology
- Comfortable high collar
- Storm flap under main zip
- Quality YKK® zips throughout
- Zipped security pocket on left chest

Colour: Dark Loden Green

Code 20A0070

Small	Medium	Large	XLarge	XXLarge	Price
36-38"	38-40"	42-44"	46-48"	50-52"	£79.99



Simms Rogue Fleece Hoody

Designed to keep you warm on the riverbank or around town, Simms Rogue Fleece Hoody is made with a polyester woven fabric backed with a DWR finish. Features include two fleece-backed handwarmer pockets and a comfortable three-panel ergonomic hood.

- Warm and water-resistant
- 3-panel ergonomic hood
- Large zipped chest pocket
- Fleece-backed handwarmer pockets
- Rib-knit at hem & cuffs
- YKK® centre zip

Colour: Raven

Code 19B0025

Small	Medium	Large	XLarge	XXLarge	Price
36-38"	39-41"	42-44"	46-48"	49-51"	£119.99



Simms Wood Trout Fill Hoody

This Simms "Wood Trout Fill" logo hoody is a technical hooded pullover designed with performance and comfort in mind. The cotton/poly blend will keep you warm and comfortable all day.

- Comfortable and warm plush 52% cotton / 48% polyester blend
- Standard front kangaroo pocket
- Fleece lined hood
- Ribbing at cuffs and waistband

Colour: Navy

Code 23A0010

Small	Medium	Large	XLarge	XXLarge	Price
36-38"	39-41"	42-45"	46-48"	49-51"	£64.99



Simms Trout Outline Hoody

This Simms "Trout Outline" logo hoody is a technical hooded pullover designed with performance and comfort in mind. The cotton/poly blend will keep you warm and comfortable all day.

- Comfortable and warm plush 52% cotton / 48% polyester blend
- Standard front kangaroo pocket
- Fleece lined hood
- Ribbing at cuffs and waistband

Colour: Charcoal Heather

Code 23A0011

Small	Medium	Large	XLarge	XXLarge	Price
36-38"	39-41"	42-45"	46-48"	49-51"	£64.99



Raglan sleeves for optimal fit and movement

Simms Lightweight Baselayer Top

A high-performance next-to-skin layer to ensure day-long moisture management and comfort. Made with soft brushed polyester with built-in odour control, quickly wicking away sweat from your body to keep you warm and dry.

- Raglan sleeves for optimal fit and movement
- Flatlock seam construction for next-to-skin comfort

Colour: Black

Code 21B0005

Small	Medium	Large	XLarge	XXLarge	Price
36-38"	39-41"	42-45"	46-48"	49-51"	£59.99



Flatlock seam construction for next-to-skin comfort

Sleeves with thumb holes to provide optional hand warmth

Simms Heavyweight Baselayer 1/4 Zipped Hooded Top

A versatile garment that is soft and comfortable enough to be worn as an extra-warm base layer, but equally suitable as a mid-layer. Made with smooth, stretchy grid-fleece for comfort, mobility and moisture-wicking performance.

- Asymmetrical zip for comfort when zipped over the nose and mouth
- Three panelled snug fitting hood
- Sleeves with thumb holes to provide optional hand warmth
- Flatlock seam construction for next-to-skin comfort

Colour: Black

Code 21B0007

Small	Medium	Large	XLarge	XXLarge	Price
36-38"	39-41"	42-45"	46-48"	49-51"	£109.99

Flat elastic waistband and flatlock seam construction for next-to-skin comfort



Simms Lightweight Baselayer Bottoms

Soft and comfortable base layer bottoms for excellent moisture management and odour control. Ideal for layering under insulated trousers in the coldest weather or for wearing under waders all year round.

- Made with soft polyester with built-in odour control
- Flat elastic waistband and flatlock seam construction for next-to-skin comfort

Colour: Carbon

Code 21B0006

Small	Medium	Large	XLarge	XXLarge	Price
28-30"	32-34"	36-38"	40-42"	44-46"	£59.99

Flat elastic waistband and fly pouch designed with minimal seams for a chafe-free, next-to-skin comfort



Simms Heavyweight Baselayer Bottoms

A fantastic item for wearing under waders or a bib and brace, made with stretch micro-grid fleece for optimum mobility, warmth and moisture wicking comfort.

- Flat elastic waistband and fly pouch designed with minimal seams for a chafe-free, next-to-skin comfort
- Stretch panels strategically designed from lower calf to ankle cuffs allow for easy integration when worn with socks and paired with waders or bibs and boots

Colour: Black

Code 21B0008

Small	Medium	Large	XLarge	XXLarge	Price
28-30"	32-34"	36-38"	40-42"	44-46"	£89.99

Stretch panels strategically designed from lower calf to ankle cuffs allow for easy integration when worn with socks and paired with waders or bibs and boots.



Convenient zipped chest pocket for essentials

Simms Thermal Midlayer 1/4 Zip Top

Simms' warmest layer for cold days, ideal for wearing under your favourite jacket for day-long insulation. A grid-fleece interior traps heat without adding bulk or limiting your range of motion, and a smooth exterior makes for seamless layering.

- Smooth grid-fleece for maximum warmth and comfort
- High collar with a quarter length zip
- Convenient zipped chest pocket for essentials

Colour: Black

Code 21B0009

Small	Medium	Large	XLarge	XXLarge	Price
36-38"	39-41"	42-45"	46-48"	49-51"	£109.99



Vision First Skin Set

A fantastic base layer set providing body temperature control through a huge range of fishing conditions. Wicking fabric made from a bamboo/polyester mix pulls sweat and excess moisture from your skin, helping to keep you dry and comfortable all day and preventing evaporation from making you cold.

- Bamboo/polyester fabric for moisture management and odour control
- Technical cut with flat seams for ultimate next-to-skin comfort
- Ideal for wearing as a base layer under waders
- Sold as a set: top and bottoms

Colour: Sandstorm

Code 21A0086 £84.99



Ideal for wearing as a base layer under waders

Technical cut with flat seams for ultimate next-to-skin comfort

Size	Small	Medium	Large	XLarge
Top	34-37"	38-41"	42-45"	46-49"
Bottom	30-32"	32-34"	34-36"	36-38"



Smooth faced grid-fleece for maximum warmth and comfort

Simms Thermal Midlayer Bottoms

Designed to keep your bottom half toasty on the coldest fishing days and a great option for wearing under waders when the water is chilly. Made with stretch grid-fleece for comfort, warmth and wicking performance.

- Smooth faced grid-fleece for maximum warmth and comfort
- Dual slash handwarmer pockets
- Tapered hem for a streamlined fit when wearing layers underneath and on top

Colour: Black

Code 21B0010

Small	Medium	Large	XLarge	XXLarge	Price
28-30"	32-34"	36-38"	40-42"	44-46"	£89.99



Simms Fleece Mid-layer Bib

Simms Fleece Mid-layer Bib with its grid-fleece lining will keep you toasty warm under your waders. A full front zip allows easy access when nature calls and the stretch-woven stirrup cuffs keep your legs in place in waders and boots.

- Abrasion and odour-resistant fabric
- Warm grid-fleece interior
- Stretch woven stirrups
- Convenient full front zip
- Zipped chest pocket

Colour: Raven

Code 18B0032

Abrasion and odour-resistant fabric

Stretch woven stirrups

Small	Medium	Large	XLarge	XXLarge	Price
28-30"	32-34"	36-38"	40-42"	44-46"	£119.99



Sunglass cleaning chamois inside bottom hem

Simms Bugstopper® Shirt

The Simms Bugstopper® Shirt with brrr's ground-breaking stretch woven nylon cooling innovation is cool to the touch and actively reduces skin temperature. Together with InsectShield® it offers you the most comfortable sun and biting insect protection available.

- brrr® cooling minerals provide an immediate and continuous cooling effect
- brrr® active wicking moves moisture away for non-stop comfort
- brrr® rapid drying delivers a fresh and crisp experience
- Treated with InsectShield® for all day insect protection
- Quick drying, wicking and UPF30
- 2 zipped, fly box compatible, chest pockets
- Sunglass cleaning chamois inside bottom hem

Colours: **A** Morada Plaid **B** Madras Plaid

Code 22A0006

Small	Medium	Large	XLarge	XXLarge	Price
36-38"	39-41"	42-45"	46-48"	49-51"	£129.99



Simms Bugstopper® Hoody

Keep biting bugs away from your skin with the Simms Bugstopper® Hoody. This quick-drying hoody features Insect Shield® technology for long-lasting protection and COR3™ fabric to fight odours and wick moisture. It's rated to UPF30 for sun protection and the arms and shoulders are cut for a full range of motion so your casting stroke isn't inhibited.

Colours: **G** Steel Heather **H** Nightfall Heather **I** Field Heather

Code 21B0059

Medium	Large	XLarge	Price
39-41"	42-45"	46-48"	£79.99

Simms Bugstopper® SunGaiter™

Lightweight, breathable SunGaiter™ protects your face from insect bites and sunburn. Made from SolarFlex® stretch fabric with UPF 50 sun protection and Insect Shield®.

- Insect Shield® long-lasting insect protection
- SolarFlex® UPF 50
- Lightweight, quick drying & breathable
- Laser-cut breathing holes
- Fits over back of cap
- Long cape for neckline coverage

Colours: **C** Cinder **D** Stone

Code 23A0031 £42.99



Simms Bugstopper® Sun Gloves

These half-fingered sun gloves protect your hands from sunburn and insect bites. Made from SolarFlex® stretch fabric with UPF 50 sun protection and Insect Shield®.

- Insect Shield® for long-lasting insect protection
- UPF 50
- Half-finger style
- Built-in stripping guard
- Long length to cover wrists

Colours: **E** Cinder **F** Stone

Sizes: S, M, L, XL

Code 23A0054 £49.99 Pair



Simms Bugstopper® Trousers

The Simms Bugstopper trousers with InsectShield® repel insects on contact. Wicking, anti-odour and UPF50 protection together with articulated knees and an adjustable waist give unbeatable performance on and off the water.

- InsectShield® lightweight nylon woven fabric
- UPF 50+ sun protection with a cooling touch
- Comfortable, adjustable, partial stretch waistband
- Two front hand pockets
- Two back pockets, one zipped
- Articulated knees for added mobility

Colour: Sandbar

Code 22A0005

InsectShield® lightweight nylon woven fabric



Articulated knees for added mobility



Small	Medium	Large	XLarge	XXLarge	Price
32"	34"	36"	38"	40"	£109.99



Simms Cutbank Chambray Shirt

Look sharp and stay fresh with a classic work shirt-inspired style. built from comfy chambray cotton-polyester blend made for everyday wear.

- Lightweight chambray cotton polyester blend provides the cool feel of cotton and the wicking performance of polyester
- Centre back locker loop and button-front closure, convenient sunglasses chamois, set in sleeves with placketed button cuff closure
- Chest pockets constructed with drop-in button closure, left chest pocket has a bonus hidden zipped pocket and sunglass/pen slot
- Back yoke extends over shoulders for enhanced stretch and mobility, finished with triple-needle topstitch for durability

Colours: **A** Cinder **B** Field Green **C** Sky Blue

Code **23A0006**

Small	Medium	Large	XLarge	XXLarge	Price
36-38"	39-41"	42-45"	46-48"	49-51"	£99.99

Fabric dries quickly and offers UPF 50 performance



Simms Guide Shirt

The all-time favourite Simms Guide shirt is back and is built with poly-nylon ripstop fabric that wicks moisture, dries quickly and offers UPF 50 performance.

- Centre back locker loop and button-front closure and convenient sunglasses chamois
- Left chest drop-in pocket with welt closure, bonus hidden zipped pocket and all pockets lined with mesh for water drainage and quick drying
- Back yoke extends over shoulders for enhanced stretch and mobility, finished with a back vent for comfort in hot, humid weather
- Adjustable, roll-up set-in sleeves secure with button closures, with cuffs designed for back-of-hand sun protection

Colours: **D** Field Green **E** Neptune Blue **F** Stone

Code **23A0007**

Small	Medium	Large	XLarge	XXLarge	Price
36-38"	39-41"	42-45"	46-48"	49-51"	£99.99

Fabric dries fast and travels well



Simms Challenger Shirt

Classic fishing shirt meets smart, modern design, the Challenger shirt brings together fast-drying materials and ample pocket storage for functionality both on and off the water.

- Lightweight polyester woven heather fabric that stretches with you, dries fast and travels well
- Centre back locker loop and button-front closure, convenient sunglasses chamois, set in sleeves with placketed button cuff closure
- Chest pockets constructed with drop-in button closure, left chest pocket has bonus hidden zipped pocket and sunglass/pen slot
- Back yoke extends over shoulders for enhanced stretch and mobility, finished with an attractive back vent for comfort in hot humid weather

Colours: **G** Cinder **H** Nightfall **I** Sky Blue

Code **23A0008**

Small	Medium	Large	XLarge	XXLarge	Price
36-38"	39-41"	42-45"	46-48"	49-51"	£79.99

Cuffs constructed with SolarFlex® knit fabric



Simms Intruder Bicomp Shirt

Takes fishing comfort and functionality to the next level, with ultimate breathable sun protection and mobility.

- Stretch-woven polyester main body that blocks the sun, combined with super stretchy side panels and underarms for maximum reach and comfort
- Classic point collar with hidden snap downs, back locker loop and a snap-front closure, with a back yoke/shoulder seam that extends over shoulders for comfort
- Zipped chest pockets for on-water essentials and convenient sunglasses chamois
- Cuffs constructed with SolarFlex® knit fabric, with extended length and envelope thumbholes for back-of-hand sun protection

Colours: **J** Sky Blue **K** Nightfall/Cinder

Code **23A0009**

Small	Medium	Large	XLarge	XXLarge	Price
36-38"	39-41"	42-45"	46-48"	49-51"	£109.99



Breathable, anti-microbial fabric

Extended, scallop-shaped cuffs for over-the-hand sun protection

UPF50 sun protection

Sage Guide Shirt

Lightweight and rugged, the Sage Guide Shirt features performance seams, articulated sleeves, and a sanded finish for optimal comfort and range of movement. Cooling technology fabric regulates body temperature and stealth pockets provide ample storage without sacrificing style.

- UPF 50 sun protection
- Breathable, anti-microbial fabric
- Moisture wicking and quick-drying
- Pure Cool fabric technology regulates body temperature
- 2 low-profile zipped chest pockets sized to fit a fly box
- Extended, scallop-shaped cuffs for over-the-hand sun protection

Colours: **A** Bronze Plaid **B** Tan **C** Blue Plaid

Code **21B0064**

Medium	Large	XLarge	Price
39-41"	42-45"	46-48"	£79.99



Quick drying & crease resistant

Snowbee XS Fishing Shirt

Ideal for the flats or the local reservoir in a blended mix of 65/35 cotton and polyester material, well suited to all climates. High wicking, drip-dry for minimal maintenance plus vented and mesh lined for coolness in summer, with winter warmth for practicality and smartness all year round.

- Quick drying & crease resistant
- Mesh lined and vented front & back
- Two large front bellows pockets
- Roll and button-up Swiss cuffs on sleeves
- Concealed button-down collars

Colours: **D** Light Sage **E** Sky Blue

Code **22A0049**

Small	Medium	Large	XLarge	XXLarge	Price
36-38"	38-40"	40-42"	42-44"	44-46"	£69.99



Off-shoulder seams for comfort

Waffle-lined, micro fleece inner

Simms ColdWeather Shirt

Keep warm and look good on the riverbank or in the pub in this hard-working, ultra-warm, brushed flannel shirt with a quick drying, waffle-lined, micro fleece inner. The off-the-shoulder seams ensure all day chafe-free comfort. The two chest pockets are large enough to securely hold fly boxes.

- Flannel, waffle fleece-lined shirt
- Quick drying warmth
- Two fly box compatible chest pockets
- Off-shoulder seams for comfort
- Slight drop tail

Colour: Atlantis Steel Plaid

Code **19B0026**

Small	Medium	Large	XLarge	XXLarge	Price
36-38"	39-41"	42-44"	46-48"	49-51"	£129.99



UPF40 sun protection

Integrated gaiter design to protect your nose, mouth and neck



brrr triple chill effect

Simms SolarFlex® Guide Cooling Hoody

Featuring the brrr® triple cooling effect and designed to keep you cool, comfortable and protected in the hottest fishing environments. Built with brrr® cooling stretch fabric technology and UPF40 sun protection. Also features a hood and integrated gaiter design to protect your nose, mouth and neck ensuring that you can get some extra coverage when you really need it out on the flats.

- Extended cuff length sleeves with thumb loops to ensure coverage when casting
- Lightweight, stretch fabric for mobility and comfort
- brrr® triple chill effect
- UPF40 sun protection
- Large, zipped back pocket for keys or essentials

Colour: Steel Blue

Code 22A0011

Medium	Large	XLarge	Price
39-41"	42-45"	46-48"	£124.99



A

Long sleeves with a built-in hood



B

Simms Technical LS Hoody - Artist

A smooth and stretch, lightweight jersey knit fabric wicks moisture away keeping you cool in hot weather. Comfortable raglan sleeves allow for maximum movement when casting.

- Long sleeves with a built-in hood
- Quick drying, wicking and UPF30
- Tarpon print on back or trout print on front.

Colours: A Brown Trout/Stone (Front) B Tarpon/Seaport (Back)

Code 23A0014

Medium	Large	XLarge	Price
39-41"	42-45"	46-48"	£54.99



C



D

Simms Technical LS T-Shirt

A smooth and stretch, lightweight jersey knit fabric wicks moisture away keeping you cool in hot weather. Comfortable raglan sleeves allow for maximum movement when casting. Long sleeves.

- Quick drying, wicking and UPF30
- Plain colours with Simms logo on front

Colours: C Seaport D Nightfall

Code 23A0012

Medium	Large	XLarge	Price
39-41"	42-45"	46-48"	£44.99



E



F

Simms Technical LS T-Shirt - Artist

A smooth and stretch, lightweight jersey knit fabric wicks moisture away keeping you cool in hot weather. Comfortable raglan sleeves allow for maximum movement when casting.

- Long sleeves
- Quick drying, wicking and UPF30
- Plain colours with fish print on back

Colours: E Trout/Sterling F Tarpon/Sea Breeze

Code 23A0013

Medium	Large	XLarge	Price
39-41"	42-45"	46-48"	£49.99



G



H

Simms SolarFlex® LS Hoody

Simms SolarFlex® hoody features Simms HeiQ technology. This quick drying, moisture wicking fishing shirt will keep you cool and protected on sweltering hot days.

- Quick drying, moisture wicking, anti-odour and SPF40
- Flat seams for maximum comfort
- Raglan sleeves for unrestricted movement
- Hidden thumb loops for added sun protection

Colours: G Sterling H Field Heather

Code 23A0015

Medium	Large	XLarge	Price
39-41"	42-45"	46-48"	£79.99



Simms Trout Outline T-Shirt

- Pre-shrunk plush cotton blend
- Simms trout outline logo on front of shirt
- Non-scratch internally printed neck label

Colours: **A** Adobe **B** Oil Blue **C** Black

Code 22A0051

Medium	Large	XLarge	Price
39-41"	42-45"	46-48"	£32.99



Simms Wood Trout Fill T-Shirt

- Pre-shrunk plush cotton blend
- Wood Trout Fill logo on front of shirt
- Non-scratch, internally printed neck label

Colours: **D** Black **E** Brown **F** Military

Code 23A0020

Medium	Large	XLarge	Price
39-41"	42-45"	46-48"	£32.99



Simms Special Knot T-Shirt

- Pre-shrunk plush cotton blend
- Simms knot logo on front of shirt
- Non-scratch internally printed neck label

Colour: Military

Code 22A0052

Medium	Large	XLarge	Price
39-41"	42-45"	46-48"	£32.99



Sage Heritage Logo T-Shirt

- Sage's tarpon heritage logo on front
- Ultra-soft 60% cotton
- Slightly heathered texture
- Comfortable collar

Colour: Tropic Blue

Code 22B0037

Medium	Large	XLarge	Price
39-41"	42-45"	46-48"	£34.99



Sage Logo T-Shirt

- Sage's logo on front
- Ultra-soft 60% cotton
- Slightly heathered texture
- Comfortable collar

Colour: Black

Code 22B0038

Medium	Large	XLarge	Price
39-41"	42-45"	46-48"	£29.99

patagonia[®]

Ultralight and stretchy



Patagonia Sun Stretch Shirt

Their most technical long-sleeved button-up shirt, designed for hot and humid conditions.

- Ultralight and stretchy 52% recycled nylon/48% T400[®] polyester blend that dries in a flash for all-day comfort and features HeiQ[®] Pure odour control
- Two vertical zipped chest pockets with plastic zips to prevent corrosion in salt water
- Collar snaps keep collar from flapping on windy days
- Hidden lens cleaner at the hem

Colours: **A** Oat White **B** Wavy Blue

Code F20A0071

Small	Medium	Large	XLarge	Price
35-37"	38-40"	42-44"	46-48"	£99.99

Generous hood designed to fit over a baseball cap



Patagonia Tropic Comfort Natural Hoody

Delivering dependable 40+ UPF sun protection this hoody is engineered from renewable, natural beech tree pulp, making it super-soft and breathable yet durable.

- Generous hood designed to fit over a baseball cap for additional sun protection
- Longer sleeve length with thumb-hole elastic at cuffs provides added sun protection on the backs of hands
- Convenient hanging loop at back for quick storage and drying
- Fair Trade Certified[™] sewn

Colours: **C** Friend Green **D** Steam Blue **E** Tailored Grey

Code F23A0145

Small	Medium	Large	XLarge	Price
35-37"	38-40"	42-44"	46-48"	£89.99

Hidden lens cleaner and haemostat dock



Lightweight, easy-care 35% organic cotton/65% recycled polyester blend

Patagonia Island Hopper Shirt

Perfect for hot weather, it's quick-drying, lightweight, highly breathable and comfortable.

- Lightweight, easy-care 35% organic cotton/65% recycled polyester blend, with HeiQ[®] Pure odour control
- Reach-through chest utility pockets with sculpted front-pocket flaps
- Collar snaps keep collar from flapping on windy days
- Hidden lens cleaner and haemostat dock

Colour: Natural

Code F23A0147

Small	Medium	Large	XLarge	Price
35-37"	38-40"	42-44"	46-48"	£99.99



Longer sleeve length with thumb-holes

Patagonia Tropic Comfort Natural Crewneck

Delivering dependable 40+ UPF sun protection and on-the-water utility, with fabric engineered from renewable, natural beech tree pulp to make it super-soft and breathable yet durable.

- Designed for easy movement that won't hinder your casting stroke
- Longer sleeve length with thumb-hole elastic at cuffs provides added sun protection on the backs of hands
- Convenient hanging loop at back for quick storage and drying
- Fair Trade Certified[™] sewn

Colours: **F** Steam Blue **G** Tailored Grey

Code F23A0146

Small	Medium	Large	XLarge	Price
35-37"	38-40"	42-44"	46-48"	£74.99



Simms Coldweather Trousers - Micro Fleece lined

Simms Coldweather trousers combat sub-zero temps with a textured micro fleece lining and COR3™ fabric. Other fisherman friendly details include handwarmer pockets, an adjustable waist and articulated knees for optimal mobility. Perfect under waders or on their own on those freezing cold mornings.

- DurapelPlus® durable water-resistant finish
- Quick-drying, moisture wicking, anti-odour & UPF 50
- Slash handwarmer pockets and two rear pockets
- Adjustable waist with plastic centre-front snap to avoid corrosion
- Double-layer, articulated knee for durability & ease of movement
- Velcro® tab for cinching the leg prior to slipping on waders

Colour: Dark Stone
Code 11A0333



DurapelPlus® durable water-resistant finish

Small	Medium	Large	XLarge	XXLarge	Price
28-30"	32-34"	36-38"	40-42"	44-46"	£92.99

ORVIS®

Orvis PRO Approach Trousers

With a new, double-weave, 4-way stretch Orvis PROACTIV fabric that strikes the perfect balance between exceptional abrasion and snag-resistance and nimble, lighter weight, the PRO Approach Trousers are perfect for fresh and saltwater wet-wade sessions.

- Water-repelling DWR coating decreases water absorption while speeding up dry time
- UPF 50+ even when wet
- Fits perfectly over wading boots
- Legs won't ride up and guard against gravel and debris when TPU-coated button snap is attached to boot
- Built-in daisy chain loops for secure tool docking inside two easy-access hand pockets
- Two roomy zipped thigh pockets
- Single zip back pocket
- Snap fly closure

Colour: Ash

Code 23A0089



UPF 50+ even when wet



Small	Medium	Large	XLarge	XXLarge	Price
32"	34"	36"	38"	40"	£149.99

Simms Bugstopper® Trousers

The Simms Bugstopper trousers with InsectShield® repel insects on contact. Wicking, anti-odour and UPF50 protection together with articulated knees and an adjustable waist give unbeatable performance on and off the water.

- InsectShield® lightweight nylon woven fabric
- UPF 50+ sun protection with a cooling touch
- Comfortable, adjustable, partial stretch waistband
- Two front hand pockets
- Two back pockets, one zipped
- Articulated knees for added mobility

Colour: Sandbar
Code 22A0005



InsectShield® lightweight nylon woven fabric



Articulated knees for added mobility

Small	Medium	Large	XLarge	XXLarge	Price
32"	34"	36"	38"	40"	£109.99

Orvis Jackson Quick Dry Trousers

An upgraded version of Orvis' best-selling quick dry trousers, featuring a 25% faster dry time, a softer, more breathable, eco-friendly fabric and four-way stretch for ease of movement and comfort. Redesigned so it's better for you and for the environment.

- 25% faster drying, softer, 100% breathable and eco-friendly
- Recycled nylon fabric with 4-way stretch
- UPF 50+ sun protection
- TurboDry® waistband for comfort, stretch, stability and fast-drying capabilities
- Secure zipped pockets (two in back, one at the side)
- Gusseted crotch for easy movement

Colour: Canyon

Code 23A0088



25% faster drying, softer, 100% breathable and eco-friendly



Small	Medium	Large	XLarge	XXLarge	Price
32"	34"	36"	38"	40"	£119.99



Ventilated, padded collar and stretch shoulder panels

6 interior pockets and 2 large rear pockets

Quick-drying, nylon fabric with Teflon® finish



Simms G3 Guide™ Vest

An updated and improved version of the top of the range Simms vest, with an impressive 24 pockets. Carries the most gear in the most comfortable way, using the best fabrics and components to ensure years of use.

- Quick-drying, nylon fabric with Teflon® finish and mesh lining
- Ventilated, padded collar and stretch shoulder panels
- 4 easy-loading moulded foam pockets
- 6 bellowed fabric pockets
- 2 thermolaminated tippet pockets
- 2 large horizontal zipped pockets
- 6 interior pockets and 2 large rear pockets
- Built-in retractors with magnetic docking station
- Fly patch, rod holder loops

Colour: Steel

Code 18A0037

Small	Medium	Large	XLarge	XXLarge	Price
36-38"	39-41"	42-45"	46-48"	49-51"	£279.00

Pocket layout includes compression moulded fly box storage pocket and stretch woven secure phone pocket on upper chest



Simms Freestone Vest

Simms ever-popular Freestone Vest perfectly combines technical performance with comfort and practicality, built with a range of features to store all your fishing essentials.

- Durable and weather-resistant nylon shell with breathable polyester mesh
- New pocket layout includes compression moulded fly box storage pocket and stretch woven secure phone pocket on upper chest
- Two large horizontal lower pockets, four flapped Velcro® drop pockets and a large, zipped rear storage pocket
- Four interior drop pockets for additional accessory and tackle storage
- Third hand rod holder and net D-ring
- Padded collar for all day comfort

Colour: Pewter

Code 21B0001

Small	Medium	Large	XLarge	XXLarge	Price
36-38"	39-41"	42-45"	46-48"	49-51"	£139.99

Durable weather-resistant nylon shell and breathable polyester mesh



Rod holder and D-ring landing net attachment

Simms Tributary Vest

A mesh style vest that offers excellent functionality and comfort. This model is made from weather-resistant nylon outer fabric and breathable polyester mesh and includes an extremely practical pocket layout.

- Two large horizontal lower pockets, six flapped pockets and a large zip-up game pocket
- Durable weather-resistant nylon shell and breathable polyester mesh
- Rod holder and D-ring landing net attachment
- Padded collar for day-long comfort

Colour: Tan

Code 21A0038

Small	Medium	Large	XLarge	XXLarge	Price
36-38"	39-41"	42-45"	46-48"	49-51"	£99.99

Super durable nylon fabric with a DWR finish



26-strategically built pockets

Simms Guide Vest

The Guide Vest is made from super durable nylon fabric with a DWR finish and features 2 built-in retractors, corrosion resistant YKK® zips, a breathable, padded collar to keep you cool and comfortable and an elastic drawcord at the waist. 26-strategically built pockets should keep all your gear organised. 2 large & 2 medium chest pockets, 6 waist pockets, 2 tippet pockets, 8 internal pockets, 1 split back pocket, 1 bellowed back cargo pocket & a dry shake pocket. 4 tool attachment D-rings

Colour: Steel

Code 18A0038

Small	Medium	Large	XLarge	XXLarge	Price
36-38"	39-41"	42-45"	46-48"	49-51"	£249.00



Faux sheepskin fly patch



3 elasticated holders for bottles of fly dressings

Snowbee Superlight Fly Vest

A super lightweight vest made from waterproof 100% nylon Taslon material and full of features for the angler. Loads of storage pockets include 4 main fly box outer pockets each with additional small pockets on the front for accessories, 2 front zip pockets and a large rear pouch pocket.

- Comfortable elasticated collar and mesh inner lining
- Rear net D-ring
- Faux sheepskin fly patch
- Coil retractor with quick release clip
- 3 elasticated holders for bottles of fly dressings
- 2 front D-rings
- Rod loop & Velcro® tag

Colour: Sage Green/Grey

Code 20A0082

Small	Medium	Large	XLarge	XXLarge	Price
36-38"	38-40"	42-44"	46-48"	50-52"	£64.99



4 x front zip pockets and 6 x Velcro® flap pockets

Rear mesh lining to keep you cool

Snowbee Classic Fly Vest - Adult and Child

A top quality, bank length fly fishing waistcoat. Constructed in 100% Tussor nylon, this ultra-lightweight fabric offers comfort and is super-fast drying.

- 4 x front zip pockets and 6 x Velcro® flap pockets
- 2 x Velcro® tippet pockets • 5 internal pockets
- Rod loop & tab plus front & rear D-rings
- Large rear zipped pocket for waterproofs • Rear mesh lining to keep you cool

Colour: Olive

Code 13A0086 (Childrens) Code 13A0088 (Adults)

Snowbee Classic Fly Vest (Childrens)					
Small	Medium	Large	Price		
32-34"	34-36"	36-38"	£59.99		

Snowbee Classic Fly Vest (Adults)					
Small	Medium	Large	XLarge	XXLarge	Price
36-38"	38-40"	42-44"	46-48"	50-52"	£72.99



2 front zip pockets, and 2 internal waterproof pockets

Breathable foam padding across the shoulders

4 main cargo pockets for fly boxes

Snowbee Geo Fly Fishing Vest

Combines the features of the previous XS and XS-Pro vests, constructed using a soft feel polycotton for the best comfort, quick drying and durability. A mid-length vest, for both wading and bank use.

- Breathable foam padding across the shoulders
- 4 main cargo pockets for fly boxes
- 5 additional front accessory pockets for floatants, leaders etc
- 2 front zip pockets, and 2 internal waterproof pockets
- Further internal zipped and mesh pockets, plus priest pocket
- Large rear bellows pocket and smaller mesh pocket
- D-rings on front, side and rear
- Microfibre sunglass cloth, removable fly drying ripple foam patch

Colour: Sage Green

Code 10147

Small	Medium	Large	XLarge	XXLarge	Price
36-38"	38-40"	42-44"	46-48"	50-52"	£119.99



Large zipped pocket and a priest pocket on the back

13 front flaps, pouch and zipped pockets

Snowbee Prestige Long Vest

Made from a hard-wearing polyester cotton with a brushed outer surface. The shoulders are reinforced with matching corduroy which helps spread the load. Velcro® epaulettes lock fishing bag straps in place so they don't slide off while walking. A thick, brushed cotton lining and all the hems are reinforced with leatherette trim. An inside waist adjuster cord with toggle-locks ensures a snug fit.

- 13 front flaps, pouch and zipped pockets
- 3 secure pockets inside
- Large zipped pocket and a priest pocket on the back
- Front rod loop and Velcro® tab, plus one rear and two front D-rings for landing nets, zingers and accessories
- Front zip and stud fastener

Colour: Olive Green

Code 15A0301

Small	Medium	Large	XLarge	XXLarge	Price
38-40"	40-42"	42-44"	44-46"	46-48"	£119.99

KEEPER
A WORLD RENOWNED BRAND

Mesh lining for comfort



Keeper Vest

A comfortable and practical mesh-lined vest with plenty of pockets.

- Comfortable rib knit collar
- Mesh lining for comfort
- 4-large, zipped front pockets
- 6-Velcro front pockets
- Built in pin on reels
- Large, zipped rear pocket
- D-ring for landing net on back

Code 22B0033

Medium	Large	XLarge	Price
38-40"	42-44"	46-48"	£49.99

fishpond

Features an integrated net slot on back



Fishpond Upstream Tech Vest

The first fishing vest to be made of 100% regenerated, post-consumer ECONYL® nylon materials. Carry everything you need within the 14 compartments, including two front pockets each capable of holding up to 4 large fly boxes.

- Adjustable shoulder straps, waist straps and a front zip closure ensures a perfect fit
- Features an integrated net slot on back
- Adjustable - one size fits most

Code 19B0047 £219.00

fishpond

Adjustable padded shoulder straps



Fishpond Sagebrush Pro Mesh Vest

A lightweight, breathable, mesh vest perfect for the warmer months. Features include an integrated rod holder and 17 functional pockets. Adjustable, one size fits all.

- Adjustable padded shoulder straps
- Large, easy-access back pouch
- Hypalon® tool attachments
- Drop-down fly bench
- Integrated net slot on back panel
- D-ring attachment

Code 22A0055 £179.99

fishpond

Six zipped front pockets



Fishpond Flint Hills Vest

A traditional looking vest loaded with modern features such as multiple pockets, cord loops and tabs for storing and securing your fly boxes, tools and accessories. It also has a mesh back to keep you cool all day. Adjustable, one size fits all.

- Adjustable padded shoulder straps
- Six zipped front pockets
- Large, easy-access back pouch
- Gear attachment tabs and cord loops
- D-ring attachment

Code 22A0056 £119.99

patagonia

Lightweight breathable mesh body



Patagonia Stealth Convertible Vest

A versatile, lightweight, vertical-pocket mesh vest made from 100% recycled fabrics delivering ample storage and organisation. The vest detaches at top and bottom so that it can be attached to other Patagonia packs. Adjustable, one size fits all.

- Vest can be worn alone or attached to Patagonia pack fronts
- Vertical-pocket configuration
- Lightweight breathable mesh body
- Multiple pockets including a zipped back storage pocket and security pockets
- Rod holder, fly patch, haemostat dock and multiple attachment points

Code F22A0133 £74.99

patagonia

Made from 100% recycled materials



Patagonia Stealth Pack Vest

Patagonia's iconic fishing vest is made from 100% recycled materials and is comfortable, quiet and water resistant and features an ingenious suspension system.

- 6-vertical front pockets
- Multiple pockets including zipped back storage pockets and security pockets
- Removable waterproof sleeve
- Rod holder, fly patch haemostat dock and multiple attachment points
- Side compression panels ensure a comfortable fit even when fully loaded

2 Sizes: Small or Large **Colours:** **A** Noble Grey **B** Sage Khaki

Code F22A0130 £159.99

GLOVES

Guideline Fir Skin CGX Fingerless Gloves

Extra warm with a wind-stopping and waterproof stretchy membrane. Inner layer of channel knitted polyester for optimal insulation and to wick moisture away. The yarns are infused with liquid titanium and have the property of retaining heat from Far-Infrared Rays (FIR) natural heating.

Colour: Black **Sizes:** M, L, XL

Code 16A0061
£39.99 pair



Simms Kispiox Neoprene Gloves

The ultimate waterproof neoprene glove with a fleece lined inner at the back of the hand. Also features a high stretch palm and a technical finger design for optimum dexterity.

Sizes: S, M, L, XL

Code 18B0070
£64.99 pair



Simms Kispiox Mitts

Toasty warm neoprene mitts designed with grid-fleece to offer high-stretch insulation and a water-repellent finish. Unique patterning allows for incremental warmth in the right areas and webbing pull loops ensure they are easy to put on in cold temperatures.

Sizes: S/M or L/XL

Code 21A0024
£29.99 pair



Sealskinz Ultra Grip Gloves

The original, 100% waterproof, windproof and breathable knitted glove. Offering great grip and an equal balance of warmth and breathability.

Colour: Black

Sizes: M, L, XL

Code 17A0512
£44.99 pair



Sealskinz Lightweight Fusion Control Gloves

A workhorse combination of breathability and unmatched dexterity in a 100% water-and-windproof glove. Ideal where increased dexterity is necessary.

Colour: Black/Grey

Sizes: S, M, L, XL

Code F21A0147
£59.99 pair



Gore-Tex® INFINIUM™ Gloves

Made from 100% windproof, anti-pill, 4-way stretch GORE-TEX® INFINIUM™ fabric these gloves feature a pre-curved shape for an articulated, flex-enhanced fit.

Simms GORE-TEX® INFINIUM™ Flex Gloves

Openings at thumb, index and middle fingers allow quick access for knot tying and line management.

Colour: Black **Sizes:** S, M, L, XL

Code 20B0035 £79.99 pair



Simms GORE-TEX® INFINIUM™ Fold-Over Mitts

Mitts snaps to back of glove allowing full use of all fingers.

Colour: Black **Sizes:** S, M, L, XL

Code 20B0036 £89.99 pair



Simms GORE-TEX® INFINIUM™ Half-Finger Gloves

Half fingers increase dexterity and sueded palms add durability and grip in key areas.

Colour: Black **Sizes:** S, M, L, XL

Code 20B0037 £64.99 pair



Simms SolarFlex® Sun Gloves

Lightweight, quick-drying & breathable SolarFlex® stretch fabric with extended cuffs and UPF50. Synthetic overlay on both stripping fingers for increased durability.

Colour: Sterling **Sizes:** S, M, L, XL

Code 20A0076
£44.99 pair



Simms Bugstopper® Sun Gloves

These half-fingered sun gloves protect your hands from sunburn and insect bites. Made from SolarFlex® stretch fabric with UPF 50 sun protection and Insect Shield®.

- Insect Shield® for long-lasting insect protection
- UPF 50
- Half-finger style
- Built-in stripping guard
- Long length to cover wrists

Colours: Cinder, Stone **Sizes:** S, M, L, XL

Code 23A0054
£49.99 pair



Snowbee Lightweight Neoprene Gloves

Lightweight neoprene with rubberised dot pattern palm and exposed tips for thumb and index finger.

Colour: Dark Green/Black **Sizes:** M, L, XL

Code 70201 £14.99 pair



Snowbee S.F.T (Seamless Fusion Technology) Neoprene Gloves

Very light and incredibly comfortable thin neoprene gloves. Fully waterproof.

Colour: Green **Sizes:** S, M, L, XL

Code 90038
£49.99 pair



Snowbee Sun & Stripper Gloves

Combined stripping and sun protection gloves protect your fingers when stripping and the back of your hand from the sun.

- Synthetic suede palm for extra grip
- Stretch lycra back provides sun protection and comfort
- Prevents cuts and grazes

Colour: Sand/Grey **Sizes:** S/M or L/XL

Code 80239 £23.99 pair



Orvis Sun Gloves

Technical, UPF50 gloves designed to protect your hands without interfering with your fishing. Breathable and quick-drying with spandex and synthetic leather palms.

Colour: Grey **Sizes:** M, L, XL

Code 19B0028
£33.99 pair



Waterworks Stripper Glove

Stripper Glove protects the first and second fingers from damage when stripping, whilst giving full sun protection to the back of your hand.

- Cool, non-reflective colour
- Salt and freshwater resistant
- Non-slip grip
- Prevents cuts and grazes
- Left or right hand

Colour: Silver/Black

Sizes: M, L, XL (state left or right)

Code 11898 £13.99 each



Fulling Mill Stripping Guard

Eliminates painful line cuts on your fingers. Very useful when fishing in saltwater or with sinking lines. One size fits all. Pack of 3.

Colour: Mixed (Red, Blue & Tan)

Code 13A0111 £7.95



CAPS

Snowbee Cap Strap

Do not lose your favourite cap! This ingenious 12inch coiled lanyard simply clips onto your cap at one end and your shirt or jacket collar at the other.



Code 70202 £7.99

Hardy Logo Classic Cap

A quality, stylish cap manufactured with a tadel construction. Cap features rear buckle adjustment and tadel undervisor and sweatband.

Colours: Orange, Olive
Code 15B0072 £34.99



Fulling Mill "Fly Patch" Cap

A fisherman's cap with a long dark visor and a built-in Velcro® patch for storing and drying your flies.

Colour: Orange
Code 19A0121 £18.95



Farlows Cotton Twill Cap

A comfortable cap to wear on the fishing bank made from 100% washed twill cotton cap.

Colours: Green, Navy, Orange
Code F17A0171 £29.99



Simms Flyweight Mesh Cap

Technical fishing cap with a mesh crown, packable dark foam brim, sweatband and adjustable Velcro® fitting.

Colours: Black or Tan
Code 21A0039 £42.99



Abu Garcia Cap

A comfortable and stylish casual cotton cap that is perfect whether you are heading out on the water or just around town.

Colour: Black
Code 20B0066 £12.99



Patagonia Fly Catcher Cap

100% organic cotton corduroy, high-crown cap with a fly-catching front patch for holding your special flies.

Colour: Industrial Green
Code F22A0261 £39.99



Patagonia Fitz Roy Trout Trucker Cap

A mid-crown trucker hat with an organic cotton front, polyester mesh back, adjustable snap closure and embroidered trout logo.

Colours: Salvia Green, New Navy
Code F20A0020 £39.99



Simms Single Haul Cap

A 100% cotton twill 6-panel cap with a quick-dry mesh sweatband and dark under-brim. Adjustable snap fitting.

Colours: Orange, Tan, Admiral Sterling
Code 18A0049 £29.99



RIO Make the Connection Cap

Rugged 100% cotton cap with a structured front panel for durability and consistent fit. Snap closure.

Colour: Barley
Code 23A0056 £24.99



Sage Chasing Trout Cap

Classic waxed cotton cap with an adjustable cloth backstrap.

Colours: Olive, Navy
Code 23A0055 £29.99



Sage Relaxed Nylon Cap

A 6-panel cap featuring the Sage logo with a comfortable fit and everyday style. Adjustable, so one size fits most.

Colour: Green
Code 21A0074 £34.99



Sage Patch Trucker

A comfortable trucker style cap with a Sage logo and a fish scale pattern. Adjustable snapback closure.

Colours: Orange, Green
Code 22B0044 £29.99



Schöffel Fly Fishing Trucker Cap

A classic cotton trucker style cap with an embroidered Schöffel Fly Fishing logo.

Colours: Charcoal, Blue, Orange
Code F23A0112 £24.99



Schöffel Tamar Fly Fishing Cap

A 5-panel, breathable cotton twill cap with an adjustable brass buckle and an embroidered Schöffel Fly Fishing logo.

Colours: Graphite, Blue, Sand
Code F23A0113 £24.99



WEATHER PROTECTION/WARM CAPS & HATS

Simms GORE-TEX® ExStream Cap

This fleece lined cap provides hardcore anglers with waterproof, breathable warmth. Fully adjustable fit with stowable earflaps.

Colour: Black
Code 21A0075 £79.99



Simms GORE-TEX® Rain Cap

A waterproof and breathable GORE-TEX® cap for rainy days.

Sizes: S/M (54-58cm) or L/XL (56-60cm)
Colours: Black, Cypress
Code 21A0077 £54.99



Simms Oil Cloth Cap

A 100% waxed cotton canvas cap with a low fit crown. Quick-dry, wicking mesh sweatband, dark under-brim and plastic catch adjustment.

Colours: Black or Coffee
Code 18A0047 £34.99



Simms Gore Infinium™ Wind Cap

A stretch fleece, windproof and breathable cap with fold down ear flaps made with GORE-TEX Infinium™.

Sizes: S/M (54-58cm) or L/XL (56-60cm)
Colour: Black
Code 21A0076 £54.99



Snowbee Ranger Hat

Made from tough 10oz cotton duck material, water resistant and cool in summer with adjustable chin cord. Inside pocket for fishing licence etc.

Sizes: M (7-7 1/8"), L (7 1/4-7 3/8"), XL (7 1/2-7 5/8")
Colours: Olive, Stone
Code 90502 £39.99



Tilley LTM6 Hat

Lightweight, broad-brimmed Nylantium® Hat that repels rain, floats and ties on in the wind. Backed by the famous Tilley guarantee.

Sizes: 7 1/8", 7 1/4", 7 3/8", 7 1/2", 7 5/8", 7 3/4", 7 3/4", 7 1/2"
Colours: Olive, Khaki
Code F18A0510 £74.99



SUN HATS/HEAD NETS

Sage Neck Gaiter - Brown Trout

A soft, stretchable neck gaiter that is long enough to pull over your face offering great UPF50 sun and wind protection. Made from Reprive recycled fabric with laser cut anti-chafe edges. Casey Underwood artwork.

Code 22A0085 £32.99



Simms SunGaiter™

Made from lightweight, quick-drying stretch fabric and featuring laser-cut breathing holes. Solarflex® fabric offers UPF50 protection and covers your face and neck from the top of your nose down to your shirt collar.

Colours:
A Cloud Camo Grey
B Sterling

Code 19A0007 £34.99



Simms Bugstopper® SunGaiter™

Lightweight, breathable SunGaiter™ protects your face from insect bites and sunburn. Made from SolarFlex® stretch fabric with UPF 50 sun protection and Insect Shield®.

- Insect Shield® long-lasting insect protection
- SolarFlex® UPF 50
- Lightweight, quick drying & breathable
- Laser-cut breathing holes
- Fits over back of cap
- Long cape for neckline coverage

Colours: **C** Cinder **D** Stone
Code 23A0031 £42.99



Buff - CoolNet UV+

The most versatile headwear you will ever use. Works as a hat, mask, scarf, balaclava, headband or bandana. This is the UV protection version. A must have for flats fishing.

Code 19A0082 £17.99



DeYoung Tarpon (UV)



Bugstinger Meateater (UV)



Bonfish Grey (UV)



Simms Superlight Sunshield Cap

A superlight cap with built-in neck protection. Ideal for those extreme days out on the water.

- Long brim with dark underside reduces glare
- Built-in neck cape
- Cord-lock adjustment for improved fit

Colour: Sterling

Code 20B0069 £34.99



Simms Bugstopper® Sunshield Cap

A lightweight, long-billed sun cap with a built-in neck cape and Insect Shield® for full protection against the sun (UPF50) and biting insects.

Size: One Size
Colour: Stone

Code 23A0030 £42.99



Simms Gallatin Sunshield Cap

Create your own shade and get full protection from the sun (UPF 50). Made from comfortable breathable and moisture wicking fabric with fishing focused fold-down ear and neck flaps.

Size: One Size
Colour: Tan

Code 21A0040 £34.99



Simms Superlight Solar Sombbrero

A superlight wide brim fishing hat with a black underbrim to reduce glare.

- One size adjustable.
- UPF50 sun protection
- 100% Tactel® with a Teflon® DWR finish
- Comfortable easy fit elastic sweatband
- Foam brim ensures it floats

Colours: **E** Sterling **F** Camo
Code 20A0081 £44.99



Simms Bugstopper® Net Sombbrero Hat

The BugStopper® Net Sombbrero has full-coverage with a mesh perimeter that blocks biting bugs. Additional details include trusted InsectShield® technology, a drawcord closure seal, and a water-shedding DWR finish.

Size: One Size
Colour: Cork

Code 20A0080 £49.99



Lifesystems Mosquito Head Net Hat

Wide brimmed hat with ultra-fine black mesh net that drops down from the crown when you need it. Pops up from small storage sack. One size.

Code 90062 £10.99



Lifesystems Head Net

Ultra-fine black mesh head net that packs into a tiny bag.

Code 90061 £5.99



INSECT REPELLENT

Lifesystems Expedition Max Repellent

A dual action, high-strength 50% DEET repellent which includes Chrysanthemum extract as an effective bite inhibitor and DermalOC® technology for long lasting protection.

100ml pump spray.
Code 22A0086 £9.99



Lifesystems Expedition Midge Repellent

This DEET free midge-repellent contains 20% Saltidin® to provide protection from midges and smaller biting insects. Protects for up to 8 hours. Suitable for use on children 2+ years and those with sensitive skin.

100ml pump spray.
Code 22A0087 £8.99



Lifesystems Tick Remover Card

Credit card sized tick remover with two different sized removal tools for any size tick. Also features a 3X built-in magnifying lens.

Code 18A0152 £4.99



Bite Relief Click

Perfect for insect bites and stings. Instantly soothes the skin using a piezoelectric pulse to reduce irritation.

Code 20A0144 £6.99



SUNCREAMS

Lifesystems SPF 50+ Sun Cream Combistick

This SPF50+ two-in-one suncream and lip salve is both sweat resistant and easy to use. 20ml.

Code 19A0100 £8.99



FLOATANTS

Gink & Xink Twin Pack Code 90138
£11.99

RRP £13.98
NOW £11.99

SPECIAL OFFER SAVE £1.99



Gink
 Best selling floatant for flies.
Code 11372 £6.99

Veniard CDC Gel
 The natural floatant for all CDC flies.
Code 80085 £5.69

Veniard's CDC Oil
 The natural floatant for Dry flies. A drop on the fly will protect it from fish slime. Supplied in a handy dispenser.
Code 90339 £5.69



Loon Up and Down Kit Code 90170
£10.99

RRP £13.98
NOW £10.99

SPECIAL OFFER SAVE £2.99



Loon Fly Spritz 2
 A spray floatant which penetrates into most fly body materials. False cast the fly to dry out after spraying.
Code 15B0096 £8.99

Frog's Fanny
 When a coating of Frog's Fanny powder is brushed on nymphs, it creates a bubble on the fly that looks exactly like an emerging insect. Excellent on CDC flies.
Code 60165 £7.99



Mucilin Line Grease
 Greatly aids leader floatation for improved presentation.
Code 11377 £2.49



Dry Shake
 A popular floatant. Drop fly in tub and the powder will reproof your waterlogged flies time and again.
Code 11380 £9.75



Leeda Fly Float
 Spray on silicone with hackle stiffener.
Code 11379 £4.99



Mucilin Silicone
 Dry fly oil hourglass.
Code 11376 £2.99



Hunt's Original Floatant
 Brush-on powder that keeps CDC flies afloat, even in the toughest of conditions.
Code 22A0080 £7.99



Hunt's High & Dry Floatant
 A dip-in and shake, pure silica powder with added desiccant, perfect for larger flies.
Code 22A0081 £8.49



SINKANTS

Loon Henry's Sinket
 Coats wet flies & nymphs with a wetting agent that makes them sink quickly.
Code 80117 £6.99



Hunt's Original Mud
 Environmentally friendly tippet degreaser that takes the shine off your line and helps it sink.
Code 22A0082 £4.99



Fullers Mud
 Helps your tippet sink.
Code 90139 £4.25



Loon Snake River Mud
 Outstanding tippet and leader sink paste. Long lasting mud will sink tippet out of sight.
Code 11368 £7.99



Quick Sink
 A sinkant for leaders.
Code 11384 £2.49



Xink
 The most popular sinkant. Apply to the leader several feet behind your floating fly will help the leader break through the surface film, making it less visible from below.
Code 11381 £6.99



Loon Deep Soft Weight
 Mouldable, non-toxic tungsten putty that is an environmentally friendly alternative to lead split shot.
Code 11369 £14.99



HOLDERS

Fishpond Floatant Bottle Holder
 A stretchable, elastic bottle holder made from jacquard webbing with a quick secure clip.
Colours: Brown Trout or Orange
Code 18B0095 £10.99



Fishpond Dry Shake Bottle Holder
 Made from unique jacquard webbing and will accommodate most dry shake bottles and features flexible, elastic sides to fit larger or smaller bottles with a secure quick clip attachment.
Colours: Brown Trout or Orange
Code 18B0096 £10.99



Bottoms Up
 A soft plastic cup holds the floatant upside down ready for immediate use. (Bottle not included).
Code 80118 £10.99



STRIKE INDICATORS

New Zealand Indicator Set
 Contains indicator tool, NZ wool strike indicator material, appropriate tubing and full instructions.
Code 17A0072 £20.99



Loon BioStrike Putty
 High floating mouldable putty. Adheres strongly to leaders. The tub contains half yellow and half pink.
Code 113601 £8.99



Loon Strike Out Yarn
 Treated with Hydrostop so it 'floats forever.' Packed in a tidy plastic tub.
Colours: Yellow or Orange
Code 11360 £6.99



Vision StrikeRight Indicators
 Highly-visible, high-floating, re-usable strike indicators that are easy to put on and take off. Aerodynamically shaped at both ends so they cause less wind resistance when casting. 6 mixed colours in each tube (2 red, 2 yellow, 2 white).
Two sizes: Medium 2 x 1cm Small 1 x .5cm
Code 18A0123 £6.99



Fish Pimp Indicators
 Increase your catch rate substantially by detecting even the slightest take. Fish Pimp Indicators float high and easy to see. They are great to cast due to their aerodynamic shape. Reusable and are easy to apply and remove. Pack of 6.
Colours: Chartreuse or Orange
Two Sizes: Mini or Regular
Code 27170 £7.25



Frog Hair EZ-ON Strike Indicators
 A quick and easy line threading system that allows for fast adjustments on all leaders. Grab the indicator and slide it up or down. One time use. Pack of 6.
Sizes: Micro 1 x 0.5cm or Small 1.8 x 1cm
Code 80106 £6.49



Fulling Mill Adhesive Foam Indicators
 Bright, easily attachable, pinch-on foam adhesive indicators. Pack of 32.
Colours: Yellow or Red
Code 22A0054 £5.25



Thingamabobber
 Revolutionary strike indicators that cast easier, float higher, attach quicker and stay in place and afloat! Assorted colours, 5 per pack.
Sizes: Small or Medium
Code 90185 £6.99



CLIPPERS

SPECIAL OFFER



Sportfish Clip and Zinger Kit
Code 90141
£9.99

RRP £12.98
NOW £9.99

SAVE £2.99



Sportfish Deluxe Clipper

Top quality stainless steel clipper with perfect super sharp cutting edge and a recessed needle.

Colours: Black or Silver/Gold

Code 11475 £6.99



Orvis Comfy Grip Nipper

Stainless steel nipper covered with Comfy Grip for excellent grip. Includes a hook eye cleaning needle.

Colours: Storm Grey or Citron

Code 19A0066 £10.49



Sierra Clipper Combo Tool

A stainless steel multi-functional tool with line clipper, nail knot tier, hook eye cleaner and hook sharpener.

Code 22B0034 £12.99



Hardy Combo Tool

Stainless steel tool combining line snips, knot-tyer, hook eye cleaner and hook sharpener.

Code 60553 £19.99



C&F 3-in-1 Clipper

Razor sharp clipper, fly-threader and eye cleaner all in one quality tool. Supplied with 2 fly-threaders and 3 replacement blades.

Code 23A0027 £26.99



Hardy Line Snips

High quality, hand finished stainless steel snips with a razor sharp edge. Also includes an enclosed pin for knots and cleaning hooks.

Code 11A0140 £16.99



Anglers Image Line Clipper

A fine quality clipper, razor sharp blades and a super sharp retractable needle. Comfortable wide grip surfaces and a non-glare satin finish.

Code 11471 £17.99



Simms Pro Nippers

USA made, durable anodised aluminium nippers with stainless steel sprung jaws and a built-in magnetic fly threader. Also features a hook eye needle and a lanyard attach point.

Colours: Pacific Blue or Simms Orange

Code 20B0048 £79.99



Veniards Tungsten Carbide Tipped Snips

Quality lightweight snips with tungsten carbide blades which stay sharper longer and cut smoother than any other edge.

Code 80138 £10.39



Loon Rogue Nippers

Made from surgical quality steel in a stealthy matte black rust-resistant finish and covered with a comfy grip. They include a straight cutting surface and a fly eye cleaner.

Code 23A0108 £9.99

ZINGERS

Sportfish Single Zinger

A quality black aluminium zinger with a 20" cord and a locking clasp. Attaches with a secure pin-on mechanism.

Code 90100 £5.99



Sportfish Double Zinger

Attach two accessories at once. Attaches with a locking pin.

Code 90101 £6.99



Simms Retractor

Features a tough, unbreakable polyurethane coil. Strong pin bar attachment.

Code 11478 £19.99



Fishpond Arrowhead Retractor

20" curled cord with a split ring at one end and a clip at the other.

Colours: Blackrock or Moss

Code 20A0106 £36.99



Fishpond 360° Swivel Retractor

Designed to be foolproof, pin the retractor to your vest and it can rotate 360° and the nylon coil hides inside the retractor with no cord or wire to snap.

Colours: Gunmetal or Lichen

Code 18A0089 £21.99

Orvis Wire Cord Zinger

Sturdy all-metal construction, with a 22" coated wire cord. Available with either pin or clip on fixing.

A Pin £15.79

B Clip £15.79

Code 19A0060



Orvis Comfy Grip Nipper & Zinger Set

Comfy Grip nippers with a quality zinger with a 20" reach.

Code 19A0061 £20.99

C&F Curl Cord

20" curled cord with a split ring at one end and a clip at the other.

Code 11479 £9.99



C&F Flex Pin Zinger

Features an 18" Kevlar cord and a powerful magnet. Attaches with a locking pin.

Code 80108 £13.99



C&F 2-in-1 Double Retractor with Fly Catcher

A double zinger with a built-in magnetic fly holder, two 12" stretchy nylon coils and a pin-bar attachment for your nippers and other small tools.

Code 20A0107 £14.99

SCISSORS, FORCEPS & PLIERS



Sportfish Scissor Pliers
A combination of forceps with serrated flats and scissors with one serrated blade. Ideal for debarbing hooks and cutting line. Ratchet open/close mechanism (see glove clamps).
Colours: Gold or Black
Size: 5.5"
Code 11487 £9.99



Sportfish Forceps
Flat surface in front half of jaws, serrated behind. Ideal for debarbing hooks. Ratchet open/close mechanism (see glove clamps).
Colours: Gold or Black
Sizes:
4" **£7.99**
5" **£8.99**
Code 11486



Sportfish Glove Clamps
Scissor pliers that are so easy to open and close. Single handed operation. Just squeeze and the ratchet will engage to keep the clamps shut. Squeeze again and they will open. Good for unhooking fish and debarbing hooks.
Sizes:
5.5" **£12.99**
6.5" **£12.99**
Code 11488



Sportfish Debarbing Pliers
Strong stainless steel construction, flat faced fine nosed pliers, with integral clippers.
Colours: Gold or Black
Code 11485 £10.99



Simms Flyweight Pliers
Weighing only 4.25oz these pliers feature a unique ergonomic shape and are made with a corrosion resistant anodised aluminium body and stainless steel jaws and cutters. They include a secure utility leash and a convenient durable holster for attaching to 38mm wading belts or braces and Simms flyweight hexsystem. Handmade in Montana, USA.
Colours: Orange, Titanium
Code 21B0018 £174.99



Sportfish Standard Forceps
Sportfish Standard Forceps are durable, hand-forged, fishing forceps made of surgical stainless steel. Can be used to remove hooks and crimp barb with 2-stage locking jaws. Straight jaws. Two sizes available.
Sizes:
4" **£4.49** 5" **£4.99**
Code 11490



Sportfish Standard Scissor Pliers/Forceps
Stainless steel forceps with integrated scissors. Useful for cutting line, unhooking fish and crimping barb. The 2-stage locking jaws ensure a secure grip. Straight jaws. Two sizes available.
Sizes:
4" **£4.49** 5" **£4.99**
Code 11489



Sportfish Needle Nosed Pliers
A handy pair of 6" high quality pliers. Ideal for smaller hooks and for cutting wire up to 30lbs.
Code 27710 £12.99

Sportfish 8" Pliers
Superb quality pliers, ideal for pike and saltwater fishing. Great for taking out hooks and for cutting heavy mono and wire.
Code 265452 £14.99



Loon Rogue Hook Removal Forceps
Handy 5½ inch forceps featuring a special hook removal tool which slides down your leader and over the eye of your fly. Built with extra tacky grip for control even when wet.
Code 21A0097 £21.99

Loon Rogue Quick Draw Forceps
Probably the very best haemostat on the market. Well thought out and designed from the tips to the jaws, to the clip-on carabiner handle. An essential fly fishing tool.
Code 17B0037 £29.99



Loon Apex HD Pliers
The perfect companion for any outing involving big flies and big fish. Constructed of lightweight aluminium, housed in a durable rubber sheath and secured with a coated steel tether. The entire system can withstand salt, neglect, heavy use and abuse.
Code 23A0046 £109.99

Loon Trout Pliers - 7.5inch
The perfect marriage of haemostats and pliers. They include a versatile cutter in the jaw with a unique design to make quick work of pinching heavy barbs, removing delicate dry flies, cutting braid, clipping light tippet and everything in between.
Code 23A0047 £64.99

TOOL SETS

Loon Nip-N-Sip XL
A heavy-duty adjustable lanyard supplied with a set of quality nippers with a built-in bottle opener, stainless steel cutting jaws, hook cleaning needle and comfy grip pads for extra grip.
Code 22A0071 £39.99

Loon Outdoors Essentials Kit
Three essentials: Loon Rogue Forceps, Loon Rogue Nippers and a Loon Rogue Zinger, supplied all together in one useful kit.
Code 22A0075 £39.99

Leeda Profil Vest Pack
Snips, zinger, forceps and leader straightener in one essential set.
Code 11A0283 £14.99

Walton's Thumb Tool
10 tool functions in one small tool. Stainless steel. A real "ultimate" usage tool.
Code 16A0125 £44.99

LANYARDS

Loon Neck Vest Lanyard
Comfortable, padded with adjustable length and made from durable paracord. Featuring five (5) Nite-Ize S-carabiner attachments.
Code 19A0063 £26.99

ACCESSORIES

FLY DRIERS AND PATCHES



C&F Rubycell Fly Dryer

A really hi-tech fly dryer featuring a microporous polyurethane liner which has the highest possible water absorption. Polypropylene cover and spring clip for attachment to vest.

Code 11387 £15.99

Amadou Leather Holder

Soft brown leather lined with amadou. 'D' ring for easy attachment.

Code 11388 £15.19



Loon Amadou Patch

Two thick pads of the highest quality Amadou will quickly dry and rejuvenate waterlogged flies. Supplied with a secure steel hanging loop.

Code 23A0048 £31.99

Clip On Sheepskin Fly Patch

Size: 9 x 7cm

Code 80076 £9.99



Tight Line Enterprises Magnetic Fly Patch

Simply attaches to your vest, shirt or jacket & holds flies in position magnetically whilst they dry. Zinc coated to protect against corrosion.

Code 70205 £15.49



Smith Creek Rig Keeper

A convenient dropper rig carry system which holds multiple rigs. Set your leaders up in advance and make the most of your time on the water. Compact, lightweight storage for tangle-free leader changes. (Flies not included).

Code 14A0602 £26.99

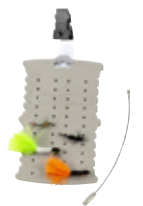

Snowbee Fly and Leader Keeper Patch

A simple accessory to keep your spare leaders & flies in one place and ready to hand. Attaches with a clip or wire cord. (Flies not included). 10.0 x 6.0cm

Code 19A0116 £6.99

KNOT TOOLS



C&F Nail Knot Pipe and Line Needle

A super-slim, quality tool for connecting monofilament leader butts to fly lines. Includes needle for piercing hole into tip of line and pipe to assist nail knot tying. Needle stores conveniently in the shaft of the pipe.

Code 11505 £13.99



Orvis Tie Fast Knot Tool

A handy nail knot tying tool that makes a difficult knot easy. Step-by-step instructions included.

Code 22B0036 £10.49



Tru Blood Knot Tyer™

This handy device is like an extra pair of hands, so you can tie blood knots quickly. An uncomplicated tool that takes minutes to learn how to use. Complete instructions included.

Code 15A0326 £17.99

SCALES



Reuben Heaton - Flyweight MK2 Scales RHS300 Series

The 300 series combines the compact features normally associated with a tubular balance, and the readability of a dial scale to give the best of both designs. The scale comes complete with a dust proof protective pouch. 40lb.

Code 27648 £27.99



Lifeventure Digital Scale

Handheld digital scales which measure in either pounds or kilograms, up to 50kg/110lbs.

Code 11A0354 £19.99



Little Gem Spring Balance

A compact pocket scale offering good accuracy. Features a high impact polycarbonate body with stainless steel hook and hanging point. Supplied with a protective pouch. Measures in both lb and kg.

Two sizes available:
6.5kg x 100g/15lb x 4oz
13kg x 200g/33lb x 8oz

Code 15A0336 £9.99

Berkley Digital Scale

Gives an accurate reading up to 50lbs. Comfort grip and fold away net hook.

Code 12A0048 £32.99



CATCH AND RELEASE TOOLS

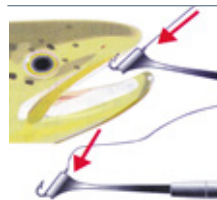

Slide tool down leader to make contact with hook

Ketchum Release Tool

Release fish without handling. Run the Ketchum Release down the leader and over the fly. The hook backs out with minimum damage to the fish. The Ketchum is moulded from carbon fibre thermo composite and is comfortable and secure when held.

2 sizes: Standard model for sizes 18 and larger.
Big Bug model for larger lures and wide bodied flies.

Code 11492 £25.99



Stonfo Quick Release Tool

High quality disgorger with shaped tubular head, designed for quick hook release without damaging the fish or fly. It is made in very strong material with anatomic rubber handle.

3 Sizes: Small for hooks sized 28 to 16.
Medium for hooks sized 16 to 8.
Large for hooks sized 8 and larger.

Code 15A0306 £10.39



Loon Ergo Quick Release Tool

A perfect tool for helping release fish. Built with an ergonomic handle and a stainless steel shaft. Ideal for hook sizes between 8-14.

Colours: Black, Yellow
Code 22A0072 £20.99

THERMOMETERS



C&F 3 in 1 Thermometer

Lightweight thermometer provides a dual °C/°F scale and the split ring enables you to hang it from your vest. One side is indented and the other contains a plastic coated coil which enables you to wrap any lengths of waste nylon onto the thermometer.

Code 11497 £21.99



Sportfish Thermometer

A 6-inch, black aluminium, riverside thermometer that accurately reads temperatures from 0° to 50° Celsius. Supplied with a secure pen clip and hanging loop.

Code 23A0061 £6.99



Sierra Kaitum Pocket Thermometer

A pocket-sized thermometer housed in an aluminium body with a convenient pocket clip and attachment ring. Accurately reads between -10° and +40° Celsius.

Code 22B0035 £12.99

PRIESTS & SCOOPS



Snowbee Prestige Priest
Made from cast aluminium, with a weighted head, rubber handle for grip and wrist lanyard.
Code 15A0304 £19.99



Leeda Profil Priest
The Profil priest features an anti slip EVA grip handle with wrist lanyard, a weather resistant aluminium shaft and chrome steel head.
Code 11A0284 £11.99



Sportfish Slim Priest
Ideal small pocket priest. 6" long with brass head.
Code 11543 £6.99



Sigma Trout Priest
This priest has a machined head with an aluminium stem and has a comfortable EVA Handle. Designed to despatch catch humanely.
Code 15A0334 £17.99



Staghorn Priest
Superb quality – hand crafted in the North of England. Suitable for trout or salmon.
Code 11542 £39.99



Sportfish Marrow Spoon Priest
Has a 3.5" brass spoon stored inside the handle. 10" when spoon in place.
Code 11541 £10.49



Brass Marrow Scoop
Brass scoop with a comfortable wooden handle.
Code 17A0522 £8.99



Farlows Stag Pocket Priest
A perfect little pocket gift for the enthusiastic fisherman, small but ideal for the job.
Code S18A0038 £27.49

FISH CARRIERS AND COOL BAGS



Wychwood Competition Bass Bags
The inner Bass bag is made from rot and odour proof rubber mesh, keeping your catch safe and fresh all day. Featuring a lockable, zipped top and a hanging, locking cord to prevent your catch from drifting away whilst you continue your fishing. The outer bag is an easy to use waterproof nylon protector, allowing safe, leak-free transit of your catch home.
Sizes:
4 Fish 55 x 35cm **£26.99**
8 Fish 65 x 45cm **£29.99**
Code 14A0424



Wychwood Rubberised Bass Bag
The rubber mesh of this bass bag makes it water, rot and odour proof. Keeps your catch safe and fresh all day.
Size: 40 x 61cm
Code 11A0108 £12.99



Trout Peg
Plastic fish carrier with comfortably shaped hand grip.
Sizes:
Trout peg with 4 plastic loops **£12.99**
2 extra loops **£3.99**
Code 90501



Wychwood Cool Bass Bag
Made with a waterproof outer and a fully foiled heat-reflecting inner. This bag is designed to keep your catch safe & fresh all day.
Size: 67 x 50cm
Code 13A0144 £19.99



Snowbee Wet Sacks
What do you do with a bass bag full of slimy, dripping fish? Use a Wet Sack. Wet Sacks are made from tough waterproof PVC with zipped tops and strong carrying handles. The smaller size is ideal for a bass bag full of fish. The larger model is great for boots, waders, waterproofs, or whatever else you care to put in it.
Sizes:
A Small – 53cm x 61cm **£19.99**
B Large – 53cm x 76cm **£24.99**
Code 20A0090

Wychwood Quick Drain Competitor Bass Bag
This zipped, waterproof, EVA bass bag features a quick-drain system and is the ideal solution to fish storage with no smell and no fuss.
Size: 70 x 15 x 55cm
Code 18A0122 £29.99



FIRST AID



Lifesystems Pocket First Aid Kit
This kit is equipped to treat most minor injuries and includes a loop on the back of the pack allowing you to attach it either to a belt or on the outside of a rucksack.
Code 16B0100 £15.99



Lifesystems Waterproof First Aid Kit
Made from tough, waterproof material, this kit contains first aid equipment for the wettest of conditions. The QuickFind system ensures that items are easy to locate inside the bag.
Code 16B0101 £34.99

FISHING TUBES



Fish Tubes
Clear, polythene tubing ideal for transporting and freezing fish.
C Trout Size – 21cm x 10m **£9.59**
D Salmon Size – 31cm x 10m **£10.79**
Code 80188

LIGHTS



Lifesystems Intensity 155 Head Torch

A lightweight LED head torch offering up to 155 lumens and 7 lighting modes. Includes 2 red LEDs, IPX6 water resistant body and an adjustable head strap. 1 x AA battery included.

Code 19A0101 £19.99



Petzl Tikka® Core Rechargeable 450 Lumens

This rechargeable, IPX4 weatherproof headlight offers a powerful 450 lumens, a long burn time with single button operation of 3 light modes and red-light options to protect your night vision. Supplied with a rechargeable battery but also works with three standard AAA batteries.

Code 23A0090 £54.99



Loon Nocturnal Rechargeable Headlamp

Rechargeable water-resistant 220 lumens headlamp that can be charged via micro USB cable (included). Provides up to 5.5 hours light on full power, and includes white, red and strobe modes in 3 brightness options.

Code 21A0083 £31.99



LEDLENSER MH5 Rechargeable Headlight

Performance head torch offering both white and red light options with adjustable power level. Rechargeable batteries supplied but also works with conventional AA batteries. An innovative mounting system allows for easy removal and reattachment and an elastic fabric headband ensures a snug fit.

Code 21A0082 £77.99

SHARPENERS



Veniards Retractable Hook Hone

A retractable hook sharpener mounted in a plastic case with a fine grit aluminium oxide stone with indentations for aligning hook points. Anchor hole for attaching to lanyard, zinger or vest.

Code 22A0091 £5.99



Loon Hook Hones

Increase your hook-up rates and keep your flies and hooks in prime condition. Features include hook sharpening slots, comfy grip handle and an easy locking attachment ring. Two sizes available each with two different grit sizes, fine and course.

Code 23A0060
2 Sizes: Standard £10.99
XLarge (Apex) £12.99



Snowbee Hook & Knife Sharpener

This sharpener has twin tungsten carbide sharpening blades for all knives, plus a grooved carbide hook-sharpener.

Code 19A0103
£5.49

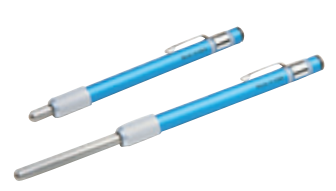

Multisharp Diamond Tool Sharpener

This handy pen style sharpener has a strong anodised aluminium case. A simple twist and lock action enables the diamond sharpening stone to be extended or withdrawn. Flat surface to sharpen knives, also long groove for sharpening hooks. Max stone length 6.6cm when extended, 13.7cm overall length.

Code 229613 £9.49

FILLETING

Please visit one of our stores to view and purchase our range of filleting knives. Over 18 only. Proof of age will be required.



Snowbee Filleting Glove

Protects your hand whilst filleting.

Sizes: S/M or L/XL

Code 16A0122
£10.99

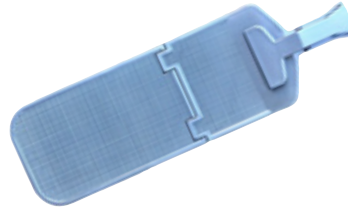

Filleting Board - Folding

A folding filleting board with a textured surface and a strong clip to hold your fish securely. Made from wipe clean PE that does not absorb fish smells. Also includes a stainless steel de-scaler and non-slip feet.

Size: Open 48 x 15cm, Folded 25 x 15cm

Code 22A0083 £13.99

SMOKER



Abu Smoker

A generously sized hot smoker/cooker made of stainless steel for easy cleaning and long life. Will take 4-5 small trout. Complete with stand, 2 adjustable burners, pan, vented lid, drip tray and grill. Cooks and smokes in one process so smoked fish is ready in as little as 15 mins.

Size: 42 x 27 x 11cm
Code 13723 £69.99

Oak Dust

Top quality English oak chippings will give a wonderful rich flavour. 250g gives 4-5 servings.

Code 13723 £4.99



KETTLES

Kelly Kettle

The original stainless steel Irish Kelly Kettle quickly and easily boils water in the windiest and wettest weather. The only fuel needed is newspaper or a handful of twigs.

3 Sizes:

A Trekker 0.6 litre

£49.49

B Scout 1.2 litre

£56.99

C Base Camp 1.6 litre

£59.99

Code 11564



Cooking Set

A saucepan, frying pan and grill that fits onto the base of the Scout and Base Camp kettles.

Code 11564 £14.99

AQUAPAC



Phone or camera equipment can still be used inside the Aquapac pouch



Aquapac

Range of waterproof accessories designed to keep your valuables dry. Uniquely, your phone or camera equipment can still be used inside the Aquapac pouch.

Code 26543



	Model	Size	Weight	Price
A	Camera Case	14 x 20cm	112g	£27.49
B	Keymaster Case	8 x 13cm	58g	£15.99
C	iPhone 5 Case	8 x 16.5cm	65g	£21.99
D	iPhone 6 Plus Case	11 x 18cm	74g	£26.49
E	iPhone Plus Plus Case	12 x 19cm	85g	£29.99
F	Tablet Case	15 x 22cm	108g	£31.99



Aquapac Toccoa™ Daysacks

These Daysacks are made from Tough 500D Vinyl and will resist scrapes & abrasion on your trip. All-welded construction seals out any water. Roll-down seal with side compression or top for maximum volume.

Capacity: 28 Litres

Weight: 900g

Dimensions: 30.4 x 40.7cm

Colours: **G** Green/Grey **H** Blue/Black

Code 14A0484 £64.99



WATERPROOF BAGS

Lifeventure DriStore Roll Top Bags

Keep the contents of your pack dry, without adding weight or bulk.

- Sizes are colour coded for quick identification
- 30 denier siliconised ripstop Cordura
- Waterproof PU coated fabric with fully taped seams
- Roll-top closure with lightweight Kross buckle
- Hypalon finger loop on the base to aid extraction
- Elliptical shape for maximum space efficiency
- This item is on the DoF Recommended Kit list

Sizes:

I Small (5L - Blue) **£11.99**

J Medium (10L - Green) **£13.99**

K Large (25L - Red) **£16.99**

Code 17A0514 Individual bags

Code 17A0513 Set of all 3 bags **£36.99**



SET OF ALL THREE BAGS NOW £36.99 SAVE £5.98

FLASKS

Lifeventure Flask

- Keep drinks hot for up to 8 hours and cool for 24 hours
- Stainless steel construction with copper coated inner wall
- Sleek design with lid that can be used as a cup

Capacity: 1 Litre

Weight: 570g

Code 16A0096

£26.99



Lifeventure Wide Mouth Flask

- Stainless steel construction
- Wide opening allows easier filling or emptying of contents

Capacity: 1 Litre

Weight: 708g

Code 16A0097

£26.99



Lifeventure Thermal Mug

- Will keep a hot drink hot for up to 4 hours
- Watertight
- Stainless steel construction with vacuum insulated walls

Capacity: 300ml

Weight: 300g

Code 16A0098

£15.99



Semperfli Flask with Thermometer

Perfect for keeping your tea and coffee hot or your cold drink cold for 6 to 12 hours and keeping its temperature. With a built-in tea strainer and a non-slip base.

Capacity: 500ml

Code 21B0097

£19.99



WRIST SUPPORT

Royal Wulff Wristlok

Prevents the caster applying too much wrist action on the back cast. Soft leather and adjustable with Velcro® closure.

Code 11537 £34.99



SEAT COVER

Wychwood Car Seat Protector

This water-resistant and dirt-resistant cover ensures your car furniture remains undamaged when fast access is required in soiled fishing clothing.

Code 12A0315

£14.99



YETI®



YETI Rambler Bottles - 18, 26 & 36oz

The virtually indestructible Rambler bottles have durable stainless steel bodies and double-wall vacuum insulation to keep beverages hot or cold while preventing condensation through their No Sweat™ design. They offer a wide mouth with Over-the-Nose™ design for easy filling, drinking and cleaning. The TripleHaul™ cap is comfortable to grip, insulated and 100% leakproof.

Colours: **A** Black **B** Charcoal **C** Navy

Capacity:

532ml / 18 US fl oz **£29.99**

769ml / 26 US fl oz **£39.99**

1.1 litre / 36 US fl oz (Navy only) **£49.99**

Code F19A0286

YETI Rambler Tumbler

Made from durable stainless steel with double-wall vacuum insulation to preserve your hot or cold beverage at all costs. The magnet on the included MagSlider™ Lid adds an additional barrier of protection for keeping drinks contained and preventing heat or cold from escaping. Please note - this magnet component is not leakproof.

Colours: **D** Black

E Stainless Steel **F** Navy

Capacity:

295ml / 10 US fl oz **£19.99**

591ml / 20 US fl oz **£29.99**

Code F19A0285



YETI Hopper Flip Soft Cooler

The YETI Hopper Flip Soft Cooler Bags are durable, leakproof, tough as nails bags that are perfect for loading with food and drinks. These go-anywhere cool bags are an everyday outdoor essential.

Flip 8 - Perfect for keeping your food and drinks cold while out in the field.

Ext Dimensions: 29.2 x 20.30 x 26.7cm **£199.99**

Flip 12 - Perfect to pack up lunch and a few drinks in.

Ext Dimensions: 32.1 x 25.40 x 29.2cm **£250.00**

Flip 18 - Carry a day's worth of lunch and a six-pack.

Ext Dimensions: 41.3 x 27.30 x 33cm **£299.00**

Please see our website for further details.

Colour: Charcoal

Code F22A0233

Yeti Travel Mug

This double-duty on-the-go drink handler is the only YETI Drinkware topped with the Rambler® StrongHold™ Lid — a leak-resistant, twist-on upgrade that's backed with a dual-slider magnet technology. Cup holder compatible - sized to be by your side through every road trip and morning commute.

Sizes: 591ml/20 US fl oz

Colour: Navy

Code F22A0264 £34.99



Yeti Rambler Bottle Cup Cap

Save some space by transforming your Rambler Bottles with the heat-locking, two-in-one companion - the Cup Cap.

Code F21A0268

£29.99



Yeti Rambler Bottle Straw Cap

Flip it open, take a sip, and close it tight to stay moving. It's leak-resistant, easy to carry (thanks to the TripleHaul™ handle), and has a wide straw opening so you get more drink with every sip. Wherever the wild takes you, the YETI Straw Cap for the Rambler Bottles makes it easy to sip without slowing down.

Code F21A0104 £12.99



YETI Roadie 24 Hard Cooler

The YETI Roadie® 24 with its compact body and solid rotomolded construction is 10% lighter, holds 20% more, and performs 30% better thermally. It is built around a ColdLock™ gasket, a Fatwall™ and a No Sweat™ design. Taller design fits a standard wine bottle upright.

Key Features

- Permafrost™ insulation
- One hand Quicklatch™ lid latches
- Heftyhauler™ handle
- Neverfail™ hinge system

Size: 42 x 36 x 44cm

Colours: **G** Tan **H** Navy **I** Charcoal

Code F20A0359 £199.99



YETI Rambler Jugs - ½ Gallon & 1 Gallon

The Rambler Jugs are designed to be almost indestructible thanks to the durable stainless steel construction and the double-wall vacuum insulation.

Will keep every drop of precious drink perfectly hot or cold.

Colour: Stainless Steel

Capacity: 1.9 litre / ½ US gallon **£99.99**

3.8 litre / 1 US gallon **£129.99**

Code F19A0287



YETI Daytrip Lunch Box

This fresh-for-hours, easy-to-clean lunch box is loaded to the gills with insulation power, engineered with a water-resistant exterior, and built with a rock-solid form factor so it holds its own when riding in backpacks and bags.

• Inside: 20.3 cm x 13.3 cm x 20.3 cm

• Empty weight: 0.5kg

Please see our website for further details.

Colour: Charcoal

Code F22A0232 £79.99



YETI Tundra 35 (25L) and Tundra 45 (36L) Hard Cooler

The Solid YETI Tundra is the perfect all-purpose cooler. Built around a ColdLock™ gasket, a Fatwall™ and a No Sweat™ design and is available in two sizes.

Key Features

- Permafrost™ insulation
- T-Rex™ lid latches
- Anchorpoint™ tie-down slots
- Neverfail™ hinge system
- Interlock™ lid system
- Vortex™ drain system
- Bearfoot™ non-slip feet

Colours: Tan, Navy

Sizes: **J** Tundra 35 (25L) 54 x 40 x 41cm **£250.00**

K Tundra 45 (36L) 65 x 40 x 41cm **£299.00**

Code F19A0280

MAYFLY ART

Featuring the highly detailed water colour paintings by UK artist Maria Gonzalez. Made in the UK.



Atlantic Salmon

Brown Trout

MayFly Art Mugs

Ceramic mug, approx dimensions: 8cm diameter x 9.3cm height. Available in Atlantic Salmon or Brown Trout.

Code 13A0202 £12.49



Teal Blue & Silver **F13A0381**



Mayfly **F13A0379**



Brown Trout **F13A0391**



Atlantic Salmon **F13A0394**

MayFly Art Greeting Cards

Blank inside for your own message. **£2.99**

CIGAR HUMIDOR



Sage Cigar Humidor

Whether taking a break while resting a fish or celebrating the one that you just released, a cigar on the water can make the day. Gasket sealed and cedar insert make this the perfect accessory for the fly angler who also enjoys good cigars. Made from the same high-end components as the Sage rod tubes and lined with cedar, they include a micro-humidor component in the cap to keep your cigars as fresh as when they went in.

Colour: Black

Code 15B0063 £54.99

GIFT VOUCHERS

Sportfish Gift Vouchers

The perfect gift when you're not sure what to buy that fisherman in your life. The gift vouchers are redeemable in any of our stores or by mail order. They come in a gift card. Available in the following denominations - £5, £10, £20, £25, £50 & £100



Code 60432

FISHING MAPS

Fishing Maps

A collection of Nigel Houldsworth's superb printed maps of famous UK salmon rivers showing their pools, beat boundaries and illustrations of various pools. The maps are printed on a high quality paper, are all signed and come rolled in a tube.

Code 20B0065

- A** River Beaulieu - 70cm x 30cm **£27.99**
- B** River Brora - 70cm x 30cm **£27.99**
- C** River Conon - 70cm x 30cm **£27.99**
- D** River Dee - 100cm x 35cm **£32.99**
- E** River Spey - 100cm x 35cm **£32.99**
- F** River Tay - 100cm x 35cm **£32.99**
- G** River Thurso - 70cm x 30cm **£27.99**
- H** River Tweed - 100cm x 35cm **£32.99**
- I** River Tyne (North) - 70cm x 35cm **£29.99**
- J** River Ure - 70cm x 35cm **£29.99**

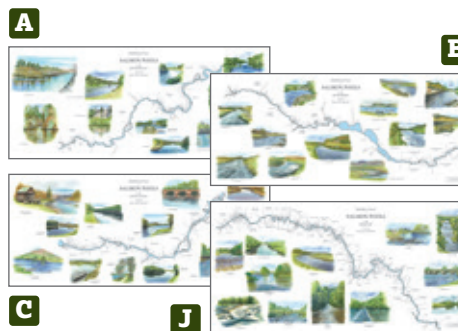

TOOL SETS

Titanium Coated Fly Tying Tool Kit - 6pcs

Titanium coated tool kit which includes premium scissors, dubbing needle, rotary whip finish tool, hackle plier, ceramic-lined bobbin holder and bobbin threader.



Code 21B0083 £29.99

Loon Core Fly Tying Tool Kit

This quality 5-piece kit from Loon contains the 5 essential core items for your fly-tying bench: scissors, bobbin, bodkin, whip finisher and hackle pliers all packed neatly and securely in a heavy-duty travel case.



Code 20B0067 £59.99

SIMMS FLYWEIGHT

Simms Flyweight Bottle Holster

Semi-structured, adjustable bottle holster constructed with 420-denier CORDURA® and lightweight 210-denier nylon ripstop fabric for durability and weather-resistance. Conveniently attaches to other Simms Flyweight carry systems via HEXGRID® webbing and is compatible with all Flyweight Pods and Accessories.



Code 21A0036

- K** Small - 7 x 7 x 16cm **£24.99**
- L** Large - 10 x 10 x 16cm **£24.99**

Simms Flyweight Pod

The ultimate lightweight storage and able to dock with other Flyweight carry systems. Built with durable CORDURA® and nylon ripstop fabric. Includes two zipped main compartments with internal organisation pockets, external accessory pocket and tool docking station and flip-down workbench.

Code 21A0032

- M** Small - 13 x 6 x 20cm **£64.99**
- N** Large - 26 x 10 x 18cm **£99.99**



HANDWARMERS

HotRox Double Sided Electronic Handwarmer with Power Bank

The comfortable rounded palm design gives up to 6 hours of two-sided heat with two heat settings. The built-in power bank will give two full charges to your smartphone. Recharged from a standard USB.



Code 18B0071 £40.99

Hot Hands

"HOT HANDS" are handwarmers that stay warm up to 10 hours. Pack of 1 pair **£1.99**



Code 14A0663

Lifesystems Handwarmers

These handwarmers offer instant heat on cold winter days. They will stay warm up to 90 minutes and are reusable. Keep them tucked inside your gloves or coat pockets for a very welcome warm-up on icy days!



Code 17B0078 £4.99 pair

LINE TRAYS



William Joseph Retractable Stripping Basket

The best ideas are often the simplest. The belt acts as a quality wading and utility belt until you need the basket which then simply tugs out ready to catch your line. Belt is breathable and fully adjustable, with lashing points for other equipment.

Code 70059 £59.99



Snowbee Stripping Basket

A hard plastic stripping basket which is popular with saltwater and reservoir anglers. Lightweight, with adjustable waist belt and neck support strap. Tapered line control turrets in the base, to prevent fly lines tangling.

Code 15A0305 £64.99



C&F Line Tray

A floating foam line tray with smooth tapered cones to catch running line. 48 x 30cm.

Code 11A0112 £59.99



Ahrex Flexistripper Line Tray

A traditional line tray, built with long flexible spikes attached to a flat flexible foam base to securely hold loops of line while casting or moving. An ambidextrous design makes it great for both right and left-handed casters, helping you to achieve greater distance, prevent tangles and protect your line from objects on the ground. Supplied with a comfortable adjustable neoprene belt.

Code 21A0085 £39.99



Snowbee Line Tray

One of the best Line Trays on the market. Mesh base with fold down base boards, holds the tray open, prevents water filling the tray from below and tangling the line when deep wading or saltwater fly fishing. Folds flat against your body when not in use. Velcro® pocket inside.

Code 60174 £32.99

FLOAT TUBE

Keeper Float Tube Kit

An incredibly comfortable and safe V-shaped twin hull float tube, with four individual inflatable bladders making this virtually unsinkable. It rides high in water for comfort when fishing, and has plenty of storage space in side panniers and forward storage area. Easily assembled and inflated in minutes.

Code 12A0130 £279.00



DROGUES



Wychwood Competition Drogue and Clamps

Parachute drogue that is fixed and adjusted simply by clamps to the gunnels.

- 25ft sq, competition legal drogue
- 6.5m rot-proof 'invisible' ropes
- Dual arms for drift steering
- Separate case with easy dry design

Code 10265 £54.99

BANK AND BOAT BAGS



Wychwood Bankman Bag

This superb bag has plenty of features and has a waterproof protective base with heavy duty nylon fabrics. A raincover is included.

Size: 42 x 28 x 23cm

Code 19A0039 £119.99



Wychwood EVA Boatman Bag

A fully waterproof version of Wychwood's popular Boatman Bag, boasting a 50L capacity and compatibility with Wychwood's EVA accessory bags, allowing you to customise your own luggage setup. Generous front and side pockets provide quick access to all your important items.

Size: 51cm x 26cm x 37cm **Capacity:** 50 litres

Code 21B0039 £119.99



Wychwood PackAway International Para-Drogue

With its own in-built stow bag this 25ft² competition legal parachute drogue is easy to store and transport and to hang to drip dry.

- Dual 5m rot-proof "invisible" ropes
- Strong C-clip metal fixings
- Dual arms for drift steering capabilities
- Easily collapsible design

Size: 1.8 x 1.3m

Code 18A0120 £39.99

LIFE JACKETS

Automatic and/or manual inflation with a 24g CO₂ cylinder



Crotch strap, D-ring and a whistle

Blue Wave Childrens Life Jacket

This British made automatic inflating lifejacket is designed for children and will fit your child from age 3 to around 12 years. It has all the features of the adult automatic jackets.

Key Features

- Automatic and/or manual inflation with a 24g CO₂ cylinder
- Integrated harness with stainless steel fittings
- Crotch strap, D-ring and a whistle
- Equivalent scale buoyancy of 150N
- European standard EN 396 and ISO12402

Colour: Navy

Size: One size fits weight range 15kg to 40kg, roughly 3-12 years of age.

Code 13A0123 £89.99 Rearming Kit 24g **£29.99**

Englands Safety

Very lightweight



BEST SELLER

Automatically inflates within 3 seconds of water immersion

Englands Survivor Life Jacket

The Survivor life jacket offers excellent value for money.

Key Features

- A fully CE approved 150 Newton life jacket at a budget price
- A very lightweight piece of equipment, available in green
- The automatic version will inflate within 3 seconds of water immersion, and will self-right an unconscious person

Colour: Green

Sizes: One size fits all. Fully adjustable

Code 27738 Automatic version **£89.99**

Code 10513 Spare Gas Unit **£44.99**



ADVICE ON SAFETY: Sadly, accidents do happen, so it is essential that you choose a safety device manufactured to the right standards and designed to both turn you over and keep your head out of the water. Our products from Englands and Blue Wave have passed rigorous safety checks to the relevant CE or EN standards. We recommend that you return equipment to the manufacturer for servicing annually.

BOAT SEATS

Comfortable quick-drying mesh seat



Wychwood Folding Boat Seat

A comfortable, rotating, folding seat that securely attaches to most thwart boards and boats using two robust ratchet straps. Made from strong yet lightweight aluminium with a comfortable quick-drying mesh seat and high back rest.

Code 20A00119 £129.99

360° rotating seat



Airflo SuperLite Elite Boat Seat

An upgrade of the most popular boat seat on the market. The SuperLite elite seat features a comfortable, padded, folding 360° rotating seat that attaches with a secure easy to fit clamp.

Code 20A0120

Clamp only **£69.99** Seat and Clamp **£219.00**

Attaches with two thick velcro straps



Airflo Comfort Zone Boat Seat Cushion

A deluxe padded cushion that attaches with two thick velcro straps.

Size: 42 x 25 x 10cm

Code 23A0091 £34.99



Sharpe's of Aberdeen has been making quality landing nets in Scotland since 1920. The flat-fronted D-Shaped (formerly "Seaforth") and also the Round (formerly "Belmont") nets are both available in two sizes – trout and sea trout. They both feature a simple and very strong fold-over mechanism with a built-in belt clip and fish-friendly knotless mesh.



Sharpe's Gye Salmon Nets

Sharpe's Gye Salmon Nets have stood the test of time and have gained a reputation for durability and flexibility. These gye nets are made from high tensile aluminium with a cast alloy powder coated block. Both nets are supplied with a Sharpe's Leather Gye Sling. Available in two sizes 20" diameter (¾" square mesh) and 27" diameter (1½" square mesh).

Code 14A0515

Model	Frame	Handle Length	Overall Reach	Price
Gye - 17/20	51cm Round	122cm Sliding	173cm	£73.99
Gye - 17/27	69cm Round	122cm Sliding	191cm	£78.99



Sharpe's Leather Gye Net Sling

The original and classic leather sling allows the angler to carry their gye net comfortably on their back and then release it with just one hand.

Code 11635 £21.49



Sharpe's D-Shaped Nets

Code 11636

Model	Frame	Handle Length	Overall Reach	Price
Trout - 41AK	41cm D-Shape	51 x 91cm Telescopic	132cm	£56.99
Sea Trout - 41CK	51cm D-Shape	61 x 112cm Telescopic	157.5cm	£59.99



Sharpe's Teardrop Shaped Gye Nets

Sharpe's of Aberdeen has extended its range of quality British handmade landing nets to include a teardrop shaped frame. These nets use the same high quality components as the rest of the Sharpe's nets. The teardrop shaped trout gye net and the sea trout gye net are both supplied with a nylon webbing sling whilst the salmon gye net is supplied with a leather sling.

Code 15A0282

Model	Frame	Handle Length	Overall Reach	Price
Trout Gye - TDT	51 x 38cm	102cm Sliding	152cm	£62.99
Sea Trout Gye - TDST	61 x 41cm	152cm Sliding	162cm	£64.99
Salmon Gye - TDLS	76 x 58cm	122cm Sliding	198cm	£78.99



Sharpe's Webbing Gye Net Sling

Works in exactly the same way as the leather sling but made out of rot-proof nylon webbing.

Code 14A0516 £17.99

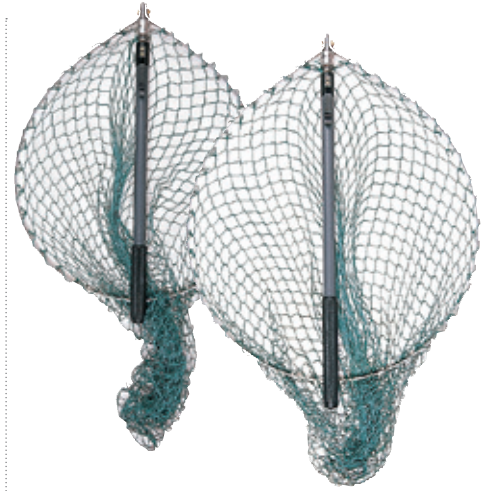

Sharpe's Round Nets

Code 11637

Model	Frame	Handle Length	Overall Reach	Price
Trout - 5AK	41cm Round	51 x 91cm Telescopic	132cm	£56.99
Sea Trout - 5CK	51cm Round	61 x 112cm Telescopic	157.5cm	£59.99



Sharpe's Replacement Knotless Net Bags

A range of soft net bags made from quality, green, rot-proof, fish-friendly knotless mesh.

Code 13704

Model	To Fit Nets	Mesh Size	Price
KL4	41 x 51cm diameter	2cm square mesh	£13.49
KL8	56 x 69cm diameter	4cm square mesh	£15.99

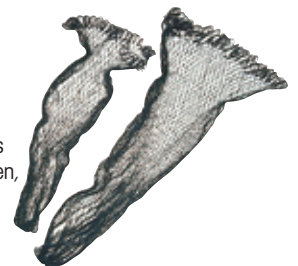



Based in Christchurch, South Island, New Zealand, McLEAN Angling specialises in the manufacturing of landing nets. Since 1987 when the first WeighNet was invented, the range has expanded to cover the needs of almost every game angler.



Scabbard (for folding nets)

21" long heavy duty nylon scabbard with a belt loop attachment. Keeps your folding net ready for action and away from thorns and barbed wire etc.

Code 80126 £26.99



McLEAN Folding LongReach Net

This net is fitted with a longer telescopic handle making it the ideal net for when you are fishing from high banks or boat fishing. The 20" diameter head is perfect for general trout or sea trout.

Code 80277

Frame	Handle Length	Overall Reach	Price
51 x 51cm	85cm	206cm	£119.99



McLEAN Short Handle Weigh Net

A quality, lightweight, short handled net with fish friendly rubber mesh. This net also includes weighing scales built into the handle (weighs up to 6.5lbs in 4oz increments). The handle is fitted with a convenient French clip for attaching to D-rings.

Code 80280

Frame	Handle Length	Overall Reach	Price
45 x 31cm	20cm	65cm	£109.99



McLEAN Salmon and Sea Trout HD Rubber Weigh Nets

Featuring tough, rot proof, anti-odour rubber mesh, extra tube strength and a durable saltwater safe coating these are McLean's toughest ever nets. The 23kg/50lbs weigh scales are concealed in a watertight compartment inside the top of the handle. The net is also marked along the shaft in inches. The adjustable carrying strap makes these pear shaped nets easy to carry.

Code SP17A0133

Model	Frame	Handle Length	Overall Reach	Price
Reservoir	55 x 46cm	88cm Sliding	143cm	£159.99
Sea Trout	64 x 53cm	102cm Sliding	165cm	£179.99
Salmon	86 x 69cm	112cm Sliding	203cm	£199.99



Also available with rubber mesh netting. Please visit www.sportfish.co.uk or call 01544 327 111 for more information.



McLEAN Folding Telescopic Nets

Bronze anodised round frames make these nets light and strong. Locking telescopic handles extend for maximum reach. Includes a secure belt clip.

Code 80125

Frame	Handle Length	Overall Reach	Price
41 x 41cm	51 x 91cm Telescopic	132cm	£109.99
51 x 51cm	56 x 112cm Telescopic	163cm	£114.99



McLEAN Telescopic Weigh Tri-Net

A folding triangular net with a telescopic handle. The built-in scales are concealed in the watertight rubber grip handle that weighs up to 14lbs. Triangular shaped. Optional scabbard available.

Code 80129

Frame	Handle Length	Overall Reach	Price
53 x 51cm	53 x 84cm Telescopic	124cm	£169.99

McLEAN Folding Ejector Tri-Net

Triangular net with a spring loaded ejecting telescopic handle. Press the button and the spring loaded handle immediately extends. Triangular shaped. Optional scabbard available.

Code 25388

Frame	Handle Length	Overall Reach	Price
48 x 51cm	51 x 79cm Ejector Telescopic	119cm	£139.99



McLEAN Telescopic Hinged Handle Weigh Net

Pear shaped solid frame with a hinged telescopic handle. The built-in scales are concealed in the watertight rubber grip handle and weigh up to 14lbs. Rubber or Soft Mesh.

Code 80128

Frame	Handle Length	Overall Reach	Price
50 x 45cm Soft Mesh	61 x 117cm Telescopic	137cm	£159.99
50 x 45cm Rubber Mesh	61 x 117cm Telescopic	137cm	£169.99



BEST SELLER



Wychwood Salmon Gye Net

A unique, robust net designed for salmon anglers to operate easily one-handed. Supplied with a deep, strong, fish-friendly, black, rubberised net mesh. The head slides down the strong hexagonal aluminium shaft and into the netting position. A quick-release, padded shoulder strap helps when wading or travelling the riverbank. Also has a salmon length:weight size guide on the handle.

Code 19A0064

Frame	Handle Length	Overall Reach	Price
Salmon 61cm Dia	132cm	183cm	£59.99



Snowbee Telescopic Folding Nets

- Black anodised aluminium handle with EVA soft-grip
- Unique "Twist & Lock" mechanism
- Strong stainless steel belt clip
- Quality aluminium frame hinge
- Genuine one-hand operation
- Glass fibre frame arms & moulded frame ends
- Knotless nylon mesh

Code 19A0030

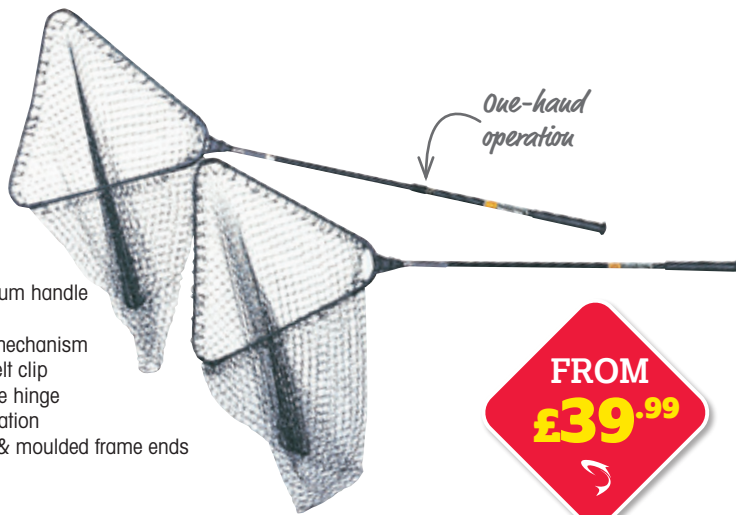

Size	Frame Size	Handle Length	Overall Reach	Price
Small	36 x 41cm Triangle	43-72cm Telescopic	110cm	£39.99
Medium	41 x 46cm Triangle	55-88cm Telescopic	132cm	£42.99
Large	46 x 51cm Triangle	58-99cm Telescopic	150cm	£44.99
XLarge	51 x 56cm Triangle	68-119cm Telescopic	172cm	£52.99
XXLarge	53 x 56cm Triangle	69-122cm Telescopic	175cm	£55.99
XXXLarge	61 x 64cm Triangle	79-142cm Telescopic	205cm	£59.99

Replacement Knotless Nets

All landing nets should use a fish friendly knotless net.

- Sizes:**
 Small 40.6cm **£8.99**
 Medium 50.8-55.9cm **£10.99**
 Large 61-66cm **£13.99**
 XLarge Salmon Gye Net **£14.99**

Code 60496

Wychwood Rover Nets

This net features an easy to use flip-over, self-locking head. The aluminium handle is telescopic and has a convenient carrying clip. Full rubber mesh as on all Wychwood nets. **Sizes:** Trout or Sea Trout

Code 13A0058

Frame	Handle Length	Overall Reach	Price
Trout 46 x 61cm	71-140cm Telescopic	211cm	£49.99
Sea Trout 56 x 71cm	71-140cm Telescopic	218cm	£54.99



Wychwood Boatman Net

A strong lightweight net with a long lockable and telescopic carbon handle. The rubber mesh is both fish and hook friendly and is also quick drying, washable and will not smell!

Code 13A0056

Frame	Handle Length	Overall Reach	Price
56cm Dia	130-239cm Telescopic	295cm	£69.99



Wychwood Bankman Net

Perfect for any bank or wading angler with a slim carbon handle which splits into two and features an aluminium ground spike. The adjustable head allows the net to be set at any angle to the handle. Also has fish friendly rubber mesh.

Code 13A0057

Frame	Handle Length	Overall Reach	Price
56cm Dia	74-150cm 2-Part	206cm	£59.99

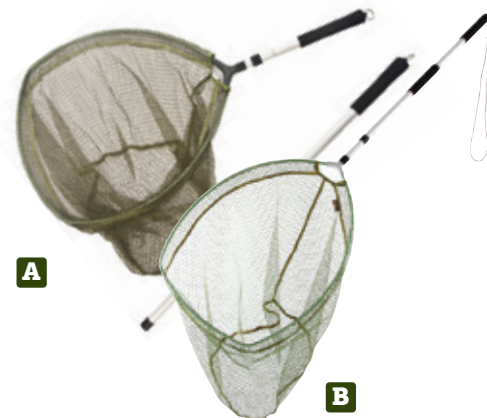

Snowbee 3-in-1 Hand Trout & Boat Nets

Both of these two 'tear drop' pan design nets use strong brass screw on joints and light but strong die cast Y frame and aluminium D frame handles. The 3-in-1 hand net, comes with a longer spare handle for lake or river use. Both use lightweight handles with foam grips and screw lock handle adjustment for perfect length on bank or boat. Hexagonal, rubber mesh nets for optimum safe catch & release and odourless storage. Elasticated lanyard to secure boat net. 3-in-1 net with short telescopic handle option complies with international competition rules and is ideal for use with magnetic net release.

Sizes:

- A** 3 in 1 Hand Trout net
 Frame 41 x 51cm
 Handles 31-46cm & 64-114cm **£55.99**
B Boat Net
 Frame 51-69cm Handle 74-135cm **£55.99**

Code 10232

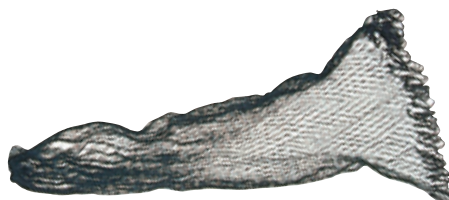

Snowbee Ranger Folding Nets

A range of folding landing nets with rubberised mesh. Solid aluminium hinges combine light weight with rugged, reliable simplicity. Easy to carry using the strong nylon belt clip on all 3 sizes. The two larger sizes have a twist and lock telescopic handle.

Code 20A0095



Rubberised mesh



Frame	Handle Length	Overall Reach	Price
46cm x 38cm	51cm Non-Tele	95cm	£39.99
48cm x 42cm	61 - 110cm Tele	160cm	£44.99
60cm x 47cm	76 - 137cm Tele	200cm	£54.99



Vision Nymphmaniac Net

This perfect sized net for the modern river angler features a lightweight aluminium frame with a short handle fitted with a maniac embossed EVA grip and a knotless rubber mesh.

Frame Size: 41cm x 50cm

Code 22B0042 £39.99



Wooden Landing Net

A classic wooden trout net with black, soft, fish friendly mesh. Supplied with an elastic cord and a secure convenient clip.

Code 16B0034 £32.99



Abu Folding Net

Easily operated telescopic landing net. Features an aluminium telescopic handle with a comfortable rubber grip, a steel spring belt clip and one handed folding mechanism. Also includes a convenient magnetic net clip.

Code 15A0431

Frame	Handle Length	Overall Reach	Price
48 x 48 x 48cm	54 x 84cm	132cm	£42.99



Greys GS Scoop Net

The Greys GS Scoop Net features an integrated magnet in the handle for safe storage when not in use and fish friendly rubber mesh to protect your quarry. A safety cord attached between the magnet and the net frame ensures that if you drop your net whilst wading it will not float away downstream.

Code 12A0028

Size	Frame	Handle Length	Overall Reach	Price
Small	39 x 28cm	19cm	60cm	£32.99
Medium	46 x 33cm	19cm	65cm	£32.99
Large	50 x 38cm	19cm	70cm	£34.99

NET HOLDERS

McLEAN Heavy Duty Magnetic Net Holder

Stronger than most to ensure that even larger nets stay in position until you need them. 2 large carabiners allow for quick attachment or cable-ties are supplied to attach a net more permanently.

Code 40058220 £29.99



Fishpond Confluence Net Release

A magnetic net release which is perfect to keep your net close. 12" coil expands to 96". Rubber strap to attach your net.

Code 18B0093 £36.99



Fishpond Net Holster

Moulded sleeve holds your net secure on any wading belt or on your Fishpond pack with webbing strap and snap.

Code 22A0070 £29.99



Hammerhead Net Retractor

A strong, high force retractor that is designed with a snap clip for attaching to a D-ring on the back or side of your waistcoat. 107cm extendable braided nylon kevlar centred cord. 2.9cm split ring.

Code 11649 £26.99



Snowbee Magnetic Net Release

This strong net release has a magnet strength of up to 4kg, so is ideal for larger nets. Supplied with two split rings for attachment and an elasticated cord to keep you connected.

Code 20B0056 £19.99

C&F Magnetic Net Releaser

True to form, C&F have designed and manufactured the ultimate net release. Attach to jacket or vest D-ring with spring loaded clip. Attach to net frame with two ratchet tie-straps provided.

Code 22953 £29.99



Smith Creek Net Holster

The Net Holster is an aluminium belt-mounted holder that keeps your net secure and out of the way.

Code 12A0311 £44.99

BANK AND BOAT BAGS



Snowbee XS Bank and Boat Bags

Made from 100% waterproof 600D polyester with a PVC laminated backing. The one-piece moulded base ensures the bags remain dry even if sitting in water. Four internal, adjustable and removable Velcro® dividers give you total storage flexibility. Numerous pockets and compartments provide ample storage for all your gear and there is even space above the dividers for large fly boxes.

- Zipped mesh pockets in lid of main cover
- Zipped external end pockets
- Comfortable, foam padded carrying handle
- Removable, adjustable shoulder strap

A Bank Bag
Size: 48 x 32 x 30cm
Code 18A0099 £87.99

B Boat Bag
Size: 61 x 42 x 36cm
Code 18A0100 £99.99

SHOULDER TROUT BAGS



Snowbee Prestige Trout Bags

The Snowbee small trout bag has a large interior with a stiffened base. 2 rear pockets, 2 front pouch pockets and 3 small accessory pockets with Velcro® flaps. Flap pocket on one side and priest pocket on the other side. The large bag is a simple, traditional style trout bag with an interior compartment and a removable washable liner. On the front are 2 large bellows pockets.

Colour: Olive Green/Black

G Small
Size: 28 x 18 x 25cm
Code 11A0124 £32.99

H Large
Size: 38 x 13 x 33cm
Code 11A0125 £34.99



Wychwood Game Bags

- Modular design for reel and accessories storage
- External and internal pockets including a tippet discard pocket
- Dual rod tube holders
- Neoprene lower back comfort panel
- EVA handle and non-slip shoulder pad
- Rubber mesh pockets are less likely to catch hooks

C Wychwood Boatman
 A large boat-type bag with numerous features and a waterproof protective base with heavy duty nylon fabrics. Includes a unique 'boat shelf compartment' and removable giant foam fly patch.

Size: 50 x 38 x 27.5cm
Code 19A0038 £139.99

D Wychwood Bankman
 This superb bag has plenty of features and has a waterproof protective base with heavy duty nylon fabrics. A raincover is included.

Size: 42 x 28 x 23cm
Code 19A0039 £119.99



Wychwood Satchel

Works well as a functional fishing bag and a laptop and workbag, perfect for the angler looking to travel light.

- Internal and external zipped and mesh pockets
- Padded, non-slip shoulder strap
- Large storage area
- Rod tube carrier
- Carry loops for nets or tools
- Tool tabs on front straps

Size: 33 x 38 x 11cm
Capacity: 13 litres
Code 19A0045 £59.99

Wychwood Flow Carry-Lite Shoulder Bag

A robust shoulder bag (15lt) made out of the same water-resistant cordura fabric. The bag features 3 large tackle pockets and a comfortable, adjustable shoulder strap.

Size: 46 x 15 x 30cm
Code 12A0248 £44.99



Wychwood Flow Carryalls

Wychwood Carryalls are made from a water-resistant, durable Cordura® fabric to protect all your tackle from the elements. They feature 'easy view' interior lining. Each compartment and pocket features two 'easy-grip' rubber zipper pullers allowing you super-fast access to your tackle.

E Compact
Size: 56 x 28 x 28cm
Capacity: 35 litres **£54.99**

F Extremis
Size: 66 x 33 x 30cm
Capacity: 50 litres **£64.99**

Code 12A024



Wychwood Rover Bag

A lightweight compact shoulder-style fishing bag with two front pockets with elasticated mesh fronts to ensure plenty of storage space for your essential items.

- Adjustable, padded shoulder strap
- Made from durable water-resistant materials
- Four mesh inner pockets
- Hidden buckle fastening

Size: 38 x 30 x 10cm
Code 20A0129 £39.99

Wychwood Rucksack

An extremely comfortable rucksack made from hardwearing materials and offering multiple storage solutions.

- Comfortable, lightweight, contemporary design
- Weight distribution back protection system
- Two rod tube carriers (*rod tubes not included*)
- Carry loops for nets or tools
- Tool tabs on front straps

Size: 48 x 25 x 15cm
Capacity: 25 litres
Code 19A0040 £79.99



HIP PACKS

patagonia[®]

Fully submersible hip pack



NEW COLOUR

Patagonia Guidewater Hip Pack - 9L

A lightweight, fully submersible hip pack that keeps your gear dry, organised and within easy reach. Features waterproof zips, adjustable hip belt with two stow pockets, padded back panel with an integrated net sheath, removable shoulder strap, adjustable rod tube holder, multiple lash points and a removable internal organiser.

Colours: **A** Salvia Green **B** Pigeon Blue

Capacity: 9 litres

Code F21A0238 £220.00

fishpond[®]

Thermoformed foam belt with built in net slot



Pack slides from front to back

Fishpond Switchback Belt System - 2L

A modular belt system including a two-litre pack, a wading belt with net slot and a shoulder strap. The innovative quick release rail system allows for the easy addition of more storage.

- Thermoformed foam belt with built in net slot
- Two-litre pack with a main zipped compartment, 2 interior pockets and an exterior velcro patch
- Pack slides from front to back
- Ambidextrous design
- MOLLE slots for water bottles, Quikshot Rod Holders etc
- Shoulder strap pad with tool attachment points

Capacity: 2 litres

Code 22A0067 £139.99

Pack attaches to wader suspenders



NEW COLOUR

Lightweight water-resistant

Patagonia Stealth Work Station

Designed for the minimalist angler, this lightweight water-resistant pack attaches to wader suspenders or belts to keep essentials close by. Featuring large zipped main pocket, two zipped accessory pockets, rear security pocket, fly patch and tool docking stations. Externally, the pack features a large stretchy front pocket, fly patches, gear attachment points and integrated magnet to hold items in place.

Colours: **C** Noble Grey **Code F21A0259**

D Salvia Green **Code F23A0161**

Capacity: 5 litres **£49.99**

VEST PACK

SIMMS

Easy-access roll-top design



Simms Flyweight Vest Pack

Head into the backcountry with the flyweight pack vest – a customisable carry solution designed to fit more like a garment than a backpack, offering easy access to essential fishing gear.

- Durable and weather-resistant 420-denier CORDURA[®] and lightweight 210-denier nylon ripstop fabric with polyurethane coating
- Easy-access roll-top design to accommodate your chosen gear, with exterior cinch straps
- Fully adjustable, low-profile shoulder harness fits close to the body and evenly distributes weight
- Shoulder harness HEXGRID[®] panel and stretch mesh pockets accommodate multiple attachments and accessories
- 2-litre HydraPak[®] reservoir included

Colour: Tan **Size:** 25.5 x 9 x 71cm **Weight:** 350g

Code 21A0029 £169.99



Semi-structured main compartment with two-way zip



Fully integrated net sheath with D-ring for utility leash attachment



Removable foam fly retainer panel



Compression straps for securing jacket

Simms Freestone Hip Pack

Comfortable, modular and designed to carry everything you need, the Freestone Hip Pack is the ultimate answer for keeping essential gear and accessories in place and ready for rapid deployment.

- Hard-wearing 330D nylon ripstop fabric with polyurethane backside
- Compression moulded toolbox with single zip to main compartment includes foam fly panel
- Stretch mesh pockets inside generous main compartment, zipped stash pocket with key clip for phone and keys
- MOLLE webbing on waist belt eliminates the need for two belts by allowing for attachment of wading staff or flyweight bottle holster: small exterior stretch pocket for additional storage
- Water bottle sheath (1 litre) on underside and compression straps for securing jacket

Colours: **D** Pewter **E** Black **F** Midnight

Size: 25 x 15 x 20cm

Capacity: 3 litres

Code 21B0013 £139.99

Simms Freestone Chest Pack

A great option for anglers looking to travel light and keep all their fishing essentials nearby. A compression-moulded main compartment and a drop-down workstation allow for excellent functionality while you're out on the water. As well as being worn as a chest pack, it can also be easily attached to a backpack to serve as an extra storage pod.

- Hard-wearing 330D nylon ripstop fabric with polyurethane backside
- Multi-functional harness design allows standalone, side-by-side or wader/pack attachment carry modes
- Three internal stretch mesh pockets and a zipped stash pocket on back panel
- Removable foam fly retainer panel
- Accessory attachments include tippet caddy, floatant holster and internal key clip

Colours: **A** Pewter **B** Black **C** Midnight

Size: 23 x 15 x 10cm

Capacity: 3 litres

Code 21B0012 £89.99

Large main compartment, small zipped exterior accessory pocket



Simms Tributary Sling Pack

An easy-wearing, convenient storage solution for anglers on the move looking to stay as lightweight as possible.

- Durable 600D recycled polyester shell fabric with 200D polyester liner
- Large main compartment, small zipped exterior accessory pocket
- Fully integrated net sheath with D-ring for utility leash attachment
- Ergonomically shaped shoulder strap (right shoulder only) with tool attachment port and adjustable sternum strap

Colour: Tan

Size: 38 x 22 x 12cm

Capacity: 10 litres

Code 21B0015 £79.99



Accessory pocket on side for additional items



Simms Challenger Mesh Duffel

Air out your wet gear between sessions with this breathable wet-storage bag that's perfect for transporting outerwear, waders, boots and more — minus the damp smells!

- Durable 600D recycled polyester fabric with highly breathable polyester mesh
- Two-way large gauge zip accesses main compartment
- Accessory pocket on side for additional items
- Padded and removable shoulder strap

Colours: **G** Hex Flo Camo **H** Black

Size: 69 x 28 x 33cm

Capacity: 60 litres

Code 21B0011 £79.99

Simms Freestone Sling Pack

A great choice for those who like to travel light but still need to carry the occasional larger item. With a compression moulded workstation, large main compartment and zipped accessory pockets, plus a comfortable shoulder strap, you'll be able to carry all your gear without feeling weighed down.

- Durable 330D nylon ripstop fabric with polyurethane backing
- Zipped secure stash pocket with key clip for phone/key storage; secondary stash pocket at top of pack holds lunch or extra layer
- Fully integrated net sheath with D-ring for utility leash attachment
- Ergonomically shaped ambidextrous shoulder strap with tool attachment port and adjustable sternum strap
- Accessory attachments include tippet caddy and floatant holster

Colours: **G** Pewter **H** Midnight

Size: 43 x 22 x 20cm

Capacity: 12 litres

Code 21B0014 £139.99

Main zipped compartment contains two large compartments for helpful packing



Simms GTS Tri-Carry Duffel

A versatile duffel bag that offers a variety of carrying methods. Choose between suitcase, over-the-shoulder and backpack carry modes depending on what gear you're transporting.

- Durable nylon ripstop fabric with PU coating, soft sided for air travel convenience
- Internal mesh storage compartments for ease of seeing contents
- Main zipped compartment contains two large compartments for helpful packing
- Dedicated footwear/dirty storage compartment at base can also be accessed from outside
- Stowable backpack straps and removeable/stowable shoulder strap

Colour: Carbon

Size: 56 x 36 x 18cm

Capacity: 45 litres

Code 21B0017 £199.99

fishpond®



Fishpond Thunderhead Submersible Sling - 13L

A waterproof, submersible sling pack made from rugged TPU coated, NewStream 100% recycled fabric with a spacious TPU-welded interior, D-rings for attaching tools, integrated net slot and a zipped quick access pocket.

- Fully waterproof, self-healing TRU® Zip
- Water resistant zipped exterior pocket
- Comfortable padded sling and back panel
- Large zip opening with removable clear interior pouch
- Integrated net slot
- Exterior Hypalon® tabs and reinforced tool loops

Colours: **A** Riverbed Camo **B** Shale **C** Yucca
Size: 40 x 23 x 18cm **Capacity:** 13 litres
Code 22A0058 £279.00

YKK Aquaguard water resistant zips



Fishpond Encampment Lumbar Pack

Sized for a couple of fly boxes and all your accessories, yet with enough support for heavier loads. Made from recycled commercial fishing net material with water-resistant zips, cord loops for securing gizmos and zipped pockets along the lumbar straps.

- YKK® AquaGuard® water resistant zips
- Structured back air mesh panel to help carry heavy loads and keep cool
- Compression straps to distribute load and can expand to hold items
- Two exterior water bottle pockets
- Can be worn as a lumbar or sling pack

Size: 29 x 13 x 20cm
Code 22A0068 £99.99



Fishpond Thunderhead Submersible Backpack - 28L

A fully submersible backpack made from TPU coated, NewStream 100% recycled fabric with a waterproof TRU® Zip and a comfortable, sturdy, harness system. This zipped, waterproof backpack will carry, protect and keep dry everything you could ever need for a day on the water.

- Fully waterproof self-healing TRU® Zip on the main compartment
- Lightweight foam shoulder strap, moulded back panel and removable hip belt
- Water resistant zip on the front pocket
- Coated webbing haul handle
- Coated webbing daisy chain and D-Ring
- Removable, interior zipped pocket and one clear stash pocket

Colours: **D** Riverbed Camo **E** Cutthroat Orange **F** Yucca
Size: 53 x 30 x 23cm **Capacity:** 28 litres
Code 22A0057 £339.00

All Fishpond bags on this page are made from 100% recycled fabric



Fishpond Thunderhead Submersible Pouch

Large enough to keep your items dry but small enough to stay out of the way, the Thunderhead Submersible Pouch easily attaches to belts, packs and frames and offers complete waterproof protection for your valuables.

- 900D TPU coated, NewStream 100% recycled fabric
- Fully waterproof, self-healing TRU® Zip
- Hypalon® panel on front for attaching accessories
- 2-large Hypalon® panels on back with nylon webbing straps with snaps

Colours: **J** Riverbed Camo **K** Yucca
Size: 28 x 18 x 7cm
Code 22A0061 £109.99



Fishpond Thunderhead Submersible Lumbar Pack - 10L

A fully submersible waterproof lumbar pack made from ultra-tough 900D TPU coated, NewStream 100% recycled fabric and designed for the mobile angler. Can be worn either as a conventional lumbar pack or with the removable shoulder strap.

- Fully waterproof, self-healing TRU® Zip
- Stretch mesh zipped front pocket
- Lightweight foam back panel and hip belt
- Numerous accessory lash attachment points
- Removable padded shoulder strap with tool attachments
- Removable interior pocket
- Integrated net slot

Colours: **G** Riverbed Camo **H** Shale **I** Yucca
Size: 34 x 23 x 13cm **Capacity:** 10 litres
Code 22A0059 £279.00



Fishpond Thunderhead Submersible Chest Pack - 5L

A waterproof chest pack built to carry and protect your gear. Integrates into other Fishpond packs or can be lashed to the side of your boat or used as a normal chest pack.

- 900D TPU coated, NewStream 100% recycled fabric
- Fully waterproof, self-healing TRU® Zip
- Zipped front stretch pocket
- Lightweight foam back with integrated net slot
- Interior organisation with zipped pocket
- Exterior Hypalon® tabs for attaching accessories
- Comfortable webbing shoulder straps

Colour: Shale
Size: 23 x 18 x 10cm **Capacity:** 5 litres
Code 22A0063 £199.99



TRU® Zip waterproof and self-healing zips



Simms Dry Creek® Zipped Backpack - 25L

A comfortable, zipped, submersible waterproof backpack built to keep your essential gear dry.

- TRU® Zip waterproof and self-healing zips
- Integrated net sleeve
- 2 stretch fabric water bottle pockets
- Moulded back panel
- Breathable padded shoulder straps with tool attachments
- Removeable waist belt features MOLLE webbing

Colour: Steel Size: 51 x 32 x 18cm

Capacity: 25 litres

Code 22A0016 £299.00

Moulded back panel with padded shoulder straps with tool attachments



Simms Dry Creek® Zipped Sling Pack - 12L

This comfortable, waterproof, submersible sling features an ergonomically shaped shoulder cross harness with a cushioned breathable foam back panel.

- TRU® Zip, waterproof and self-healing zip
- Integrated net sleeve with D-Ring
- Moulded back panel with padded shoulder straps with tool attachments
- Water-resistant exterior pocket
- 1 large internal pocket and 2 stretch mesh pockets with a key clip
- Hypalon lash points

Colour: Steel Size: 38 x 24 x 10cm

Capacity: 12 litres

Code 22A0015 £229.00

Docking station for tools and accessories

TRU® Zip, waterproof and self-healing zip



Simms Dry Creek® Zipped Hip Pack - 8L

A zipped, waterproof, submersible and exceptionally rugged hip pack for comfortable carrying and easy access to your essential fishing gear.

- TRU® Zip, waterproof and self-healing zip
- Interior stretch mesh pockets
- Docking station for tools and accessories
- Comfortable, padded, removable waist belt
- Exterior lash points

Colour: Steel Size: 22 x 32 x 17cm

Capacity: 8 litres

Code 20A0099 £199.99

A



B



Simms Dry Creek® Rolltop Backpack - 30L

A large, 30 litre, waterproof roll-top backpack built to haul your gear whilst keeping it dry and protected.

- Interior stretch-mesh storage pocket
- Exterior lash points with built-in easy-access tool storage
- Water-resistant back-panel and padded shoulder straps with tool port and fly patch
- 2 stretch mesh water bottle pockets
- Removable waist strap
- D-ring and Hypalon lash ports

Colours: **A** Black **B** Orange Size: 69 x 30 x 20cm

Capacity: 30 litres

Code 22A0017 £179.99

2-stretch fabric water bottle pockets



Clear window allows organisation and accessibility

Waterproof, submersible, self-healing, toothless Tru® Zip

Simms Dry Creek® Zipped Gear Pouch - 4L

The Simms Dry Gear Pouch keeps all your valuables and essentials 100% dry and easily accessible.

- Waterproof, submersible, self-healing, toothless Tru®Zip
- Welded seams and double-sided TPU-coated fabric
- Clear window allows organisation and accessibility
- Exterior lash points

Colour: Pacific Size: 25 x 35 x 8cm

Capacity: 4 litres

Code 20A0100 £64.99



Padded, removable shoulder straps convert from duffel to backpack

Large opening to main compartment

Durable CORDURA® outer with a water-resistant PU coating

Simms GTS Gear Duffels

Simms GTS Gear Duffels are hardworking versatile duffels perfect for getaway weekends or organised destination trips.

- Durable CORDURA® outer with a water-resistant PU coating
- Large opening to main compartment
- Zipped front pocket, mesh lid pocket & internal drop pocket
- Padded, removable shoulder straps convert from duffel to backpack
- Reinforced grab handles
- Durable padded base
- Reinforced daisy chain & lash points for rod tube attachment
- Pass-through sleeve for attachment to other luggage

Colour: Carbon

Sizes:

A Size: 60.9 x 41.9 x 22.8cm Capacity: 50 litres **£139.99**

B Size: 71.1 x 50.8 x 26.6cm Capacity: 80 litres **£169.99**

Code 20B0052



Durable, padded, semi-structured travel cubes

Simms GTS Padded Cubes

Simms GTS Padded Cubes are durable, padded, semi-structured travel cubes designed to keep your fishing tools and essential gear organised and protected. Made from CORDURA® ripstop with a water-resistant PU coating. An interior zipped mesh pocket serves as a divider. External compression straps sync with the clip-compatible Simms GTS Roller & Duffels.

Colour: Orange

Sizes:

C Small - 15.2 x 10.1 x 8.9cm **£28.99**

D Medium - 30.5 x 14.2 x 15.2cm **£38.99**

E Large - 34.0 x 17.0 x 17.2cm **£46.99**

Code 20B0055

HARDY
ALNWICK | ENGLAND



Beautiful handmade British canvas bags with leather trims. Perfect on the riverbank or as a stylish travel accessory. Very limited stock available.

Hardy Troutfisher Bag

Traditional, strong trout fisher's bag with netting on the front. Inside it has one main compartment and two pockets.

Size: 40 x 39 x 10cm

Capacity: 4 litres

Code 18B0015



SPECIAL OFFER

WAS £329.00 NOW £249.00 SAVE £80.00

Hardy Carryall Bag

A comfortable Hardy bag with two large front pockets and a generous back pocket. Ideal for anglers and travellers alike.

Size: 45 x 40 x 11cm

Capacity: 4 litres

Code 18B0015



SPECIAL OFFER

WAS £279.00 NOW £209.00 SAVE £80.00

YETI

Hydrolock™ Zipper - makes sure water stays out so your gear stays bone-dry



YETI Panga Submersible Backpack

The YETI Panga Submersible Backpack 28L is an airtight citadel. Its ergonomic DryHaul™ shoulder straps offer extra carrying comfort, while the removable chest straps and waist belt provide added stability and security while you trek. There's no need to carry it over your head while you wade or blink an eye if left out in the rain because it's 100% waterproof.

- Hydrolock™ Zipper - makes sure water stays out so your gear stays bone-dry, no matter how torrential it gets
- U-Dock™ - The terminal end of your HydroLok Zipper that ensures a completely airtight seal
- Thickskin™ Shell - The Thickskin Shell is made of high-density nylon and thick TPU lamination to be puncture and abrasion resistant

Colours: **F** Storm Grey **G** Tan

Size: 17.8 x 50.8 x 31.8cm Weight: 1.8kg

Capacity: 28 litres

Code **F19A0297** Storm Grey **F22A0266** Tan **£299.00**

fishpond®



Hypalon® attachments for tools and accessories

Fishpond Summit Sling 2.0

Keep all your must-have gear handy and accessible with this comfortable and convenient quick access sling loaded with features.

- 7 interior and exterior pockets
- 2 large main compartments easily hold fly boxes
- Moulded foam drop-down fly bench
- Hypalon® attachments for tools and accessories
- Shoulder strap workstation with tabs for accessories
- Built in net sleeve on back panel
- External water bottle holder
- Made from Cyclepond recycled fabric

Colours: **A** Granite **B** Tortuga
Size: 33 x 22 x 23cm

Code 22A0066 £139.99

fishpond®



Made from 100% recycled fabric

Fishpond Wind River Roll Top Backpack - 38L

A roll-top, waterproof backpack with a thermoformed back panel and a removable and adjustable hip belt. The main compartment has a zipped pocket and a removable, zipped internal clear pouch for valuables. Integrates with other Fishpond vests and packs. Supplied with a set of straps to carry rods, nets, etc.

- 900D TPU coated, NewStream 100% recycled fabric
- Front zipped stretch mesh pocket
- Lightweight foam shoulder strap, hip belt and moulded back panel
- Coated webbing haul handle

Colour: Shale
Size: 61 x 30 x 20cm closed or 79 x 30 x 20cm open
Capacity: 38 litres
Code 22A0062 £259.00

fishpond®

Hypalon® tabs for tools and accessories



Fishpond Cross Current Chest Pack - 8L

This high positioned chest pack carries everything you need for a day on the water. Main features include a secure magnetic opening front pocket/work shelf and a rear net slot.

- Compatible with Fishpond backpacks
- Front magnetic closure pocket
- Front main zipped compartment
- Two front small stretch mesh pockets
- Hypalon® tabs for tools and accessories
- Integrated net slot on back
- D-ring on back

Colour: Gravel **Size:** 28 x 22 x 14cm
Capacity: 8 litres

Code 18B0090 £169.99

fishpond®

Built in rod tube attachment on the front



Fishpond Green River Gear Bag - 25L

Conveniently sized tackle bag with a moulded waterproof bottom to keep all your gear organised and protected. The main compartment is fully customisable with adjustable, removable, padded dividers.

- Zip down fly bench pocket with replaceable foam
- Built in rod tube attachment on the front
- Rope handle and comfortable, adjustable, shoulder strap
- Exterior hypalon tool attachment points
- Front slash pocket for pliers or forceps and four exterior zipped pockets
- Rugged Cyclepond recycled fabric

Colour: Granite
Size: 43 x 20 x 25cm
Capacity: 25 litres
Code 18A0109 £209.00



2 large rear fly box pockets with internal leader pockets



Snowbee Ultimate Chest Pack

Designed for the roving angler who likes to travel light, the Snowbee Chest Pack sits high on your chest. Ideal for use with waders, keeping it clear of the water.

- 2 large rear fly box pockets with internal leader pockets
- 2 smaller front zipped pockets for fly boxes, tippet spools etc
- Front zipped mesh pocket for leaders, floatants, sinkants etc
- Fold-down ripple-foam fly patch
- 2 side external coil retractors for forceps & snips
- 2 elasticated loops for floatant & sinkant bottles
- A novel tippet holder for up to 5 small spools

Colour: Two Tone Sage Green **Size:** One size fits all
Code 19A0076 £64.99

fishpond®



Large clamshell opening and moveable interior dividers

Fishpond Flathead Sling Pack - 10L

An ambidextrous sling that can be comfortably worn across either shoulder with a large clamshell opening and moveable interior dividers.

Colour: Gravel
Size: 35 x 13 x 27cm
Capacity: 10 litres
Code 19B0048 £169.99

patagonia[®]



Fully submersible hip pack

Patagonia Guidewater Hip Pack - 9L

A lightweight, fully submersible hip pack that keeps your gear dry, organised and within easy reach. Features waterproof zips, adjustable hip belt with two stow pockets, padded back panel with an integrated net sheath, removable shoulder strap, adjustable rod tube holder, multiple lash points and a removable internal organiser.

Colours: **A** Salvia Green **B** Pigeon Blue
Capacity: 9 litres

Code F21A0238 £220.00



Padded adjustable shoulder straps

Comfortable back panel

Patagonia Guidewater Backpack - 29L

A fully waterproof, submersible backpack with minimalist construction to reduce weight without sacrificing durability. Features a comfortable back panel, padded adjustable shoulder straps, adjustable rod tube holder, integrated net sheath, a wide opening waterproof YKK main zip, additional lash points and a convenient internal organiser pocket.

Colours: **C** Salvia Green **D** Pigeon Blue
Capacity: 29 litres

Code F21A0240 £280.00



Dual-direction waterproof main zip

Internal organiser pocket

Patagonia Guidewater Sling - 15L

A lightweight, fully submersible sling pack that can be worn over the left or right shoulder. Features a comfortable back panel and shoulder strap, an integrated net sheath, a dual-direction waterproof main zip and a convenient internal organiser pocket.

Colours: **E** Salvia Green **F** Pigeon Blue
Capacity: 15 litres

Code F21A0239 £230.00



Extremely water-resistant

Patagonia Disperser Roll Top Pack - 40L

An extremely water-resistant roll-top backpack which adjusts to securely carry large or small loads. The comfortable shoulder straps do not absorb or retain water and the back panel has an integrated net sheath. The large main compartment contains a removable internal organising pocket.

Colours: **G** Salvia Green **H** Pigeon Blue
Capacity: 40 litres

Code F21A0241 £199.99



Multiple tool attachment points

Net holster and bottle holder

Patagonia Stealth Sling Pack - 10L

An ambidextrous lightweight sling pack with ample storage and intuitive organisation features, including multiple tool attachment points, net holster and bottle holder. This water-resistant pack is built for epic day trips with enough room for everything you need to carry.

Colours: **I** Salvia Green **J** Noble Grey
Capacity: 10 litres

Code F21A0236 £139.99



Integrated magnets for tools, zipped pockets on belt straps

Zippered pockets on belt straps

Patagonia Stealth Hip Pack - 11L

This water-resistant lightweight hip pack won't hinder your casting stroke. Featuring a large main compartment with dividers, removable waterproof pocket and removable shoulder sling. Includes integrated magnets for tools, zipped pockets on belt straps and a lower sleeve to hold a water bottle or jacket.

Colours: **K** Salvia Green **L** Noble Grey
Capacity: 11 litres

Code F21A0237 £139.99

SIMMS

Simms GTS (Gear Transport System) Roller - 110L

This rugged and tough wheeled bag with its water-resistant PU coating and ballistic nylon base must be the ultimate fishing travel bag.

- Clamshell zipped opening to main top compartment
- Internal compression straps and attachments sync with Simms GTS Packing Kit & GTS Padded Cubes
- Middle and lower wet & dry separate storage compartments
- Rugged balanced wheels with a reinforced skid plate
- Sturdy telescopic handle
- Comfortable, reinforced grab handles
- Quick access front pocket

Colour: Carbon

Size: 80.0 x 43.9 x 38.1cm

Capacity: 110 litres

Weight: 4.9kg

Code 20B0053 £419.00

Clamshell zipped opening to main top compartment



Rugged balanced wheels with a reinforced skid plate

fishpond

Comfortable rope grab-haul handles on top and front

Lockable, two-way, YKK zipped, clamshell opening



Fishpond Grand Teton Rolling Luggage - 125L

The Grand Teton is just the job when you need a travel system to hold all your necessary gear for a multi-week adventure anywhere.

- Fits up to six 89cm rod tubes in protected cradles
- Lockable, two-way, YKK zipped, clamshell opening
- Firm compression moulded bottom
- Interior neoprene stretch mesh zipped pockets
- DWR bottom section keeps your damp waders, boots and clothing separate.
- Interior main pocket can be accessed from inside or outside the bag
- Four exterior compression straps
- Comfortable rope grab haul handles on top and front
- Tall retracting telescopic handle
- Durable and rugged wheels
- Made from tough Cyclepond ripstop fabric

Colour: Granite **Size:** 89 x 41 x 28cm

Capacity: 125 litres **Weight:** 5.15kg

Code 18A0111 £469.00

SIMMS

Made from lightweight yet strong CORDURA® ripstop



Simms GTS (Gear Transport System) Packing Pouches - 3 Pack

Three zipped packing pouches to help you keep all your gear organised and compact whilst travelling. The large zipped compartments make packing easy and the mesh ventilation allows your belongings to breathe. Made from lightweight yet strong CORDURA® ripstop with a water-resistant PU coating and breathable ripstop mesh. Set of 3: S, M & L.

Colour: Simms Orange

Sizes:

A Large - 35.6 x 25.4 x 15.9cm

B Medium - 29.8 x 19.7 x 12.7cm

C Small - 19.7 x 15.2 x 8.9cm

Code 20B0054 £74.99 (Set of 3 - S, M & L)

fishpond

Interior neoprene stretch mesh zipped pockets

Made from tough Cyclepond ripstop fabric

Exterior quick access organisation pocket



Tall retracting telescopic handle

Lockable, two-way, YKK zipped clamshell opening

Durable and rugged wheels

Fishpond Teton Rolling Carry-On - 45L

This well thought out and durable rolling carry-on bag allows you to roll up at the airport with a passport, a change of clothes and all your essential fishing gear in one bag.

- Lockable, two-way, YKK zipped clamshell opening
- Made from tough Cyclepond ripstop fabric
- Firm compression moulded bottom
- Rod tube attachment on each side with a set of rod straps
- Tall retracting telescopic handle
- Durable and rugged wheels
- Comfortable rope grab handle on top
- Interior neoprene stretch mesh zipped pockets
- Exterior quick access organisation pocket
- Exterior hidden zipped stash pocket

Colour: Granite **Size:** 56 x 33 x 27cm

Capacity: 45 litres **Weight:** 3.4kg

Code 18A0110 £329.00



Snowbee XS Travel Bag - 102L

This upgraded version of an old favourite incorporates a square opening flap entry to the main compartment for easy loading and two lockable 'flexible liner' end compartments to store dirty clothes and gear. The bag also features a tough roller-wheel system and a pull-out handle for easier transportation and greater stability. The reinforced padded base is designed to take 10ft 4-pce rods, waders, boots and the rest of your fishing gear.

Size: 94 x 34 x 36cm **Weight:** 4.5kg **Capacity:** 102 litres
Code 70047 £189.00



Snowbee XS Stowaway Travel Case

The Snowbee XS Stowaway travel case is designed to fit snugly into the base of the XS Travel bag. This provides a perfect day case to safely store your rods, reels, fly boxes and accessories once you reach your destination. Also makes a great boat bag for the reservoir angler to carry all their rods, reels, fly-boxes, tippets and accessories in just one bag.

Size: 92 x 26 x 13cm **Weight:** 2.5kg
Code 14A0470 £99.00

BUY BOTH & SAVE £29.00

SPECIAL OFFER

BUY BOTH BAGS TOGETHER FOR ONLY £259.00
PLEASE QUOTE P17108



Reinforced haul handles



Stout rugged wheels

Patagonia Black Hole Wheeled Duffel - 100L

A large, 100 litre, tough and weather resistant wheeled bag from Patagonia with rugged oversized wheels and a telescopic handle.

- Burlly recycled polyester ripstop with highly weather-resistant TPU-film laminate and a DWR finish
- Large zipped opening to main compartment
- Zipped side pocket and mesh pockets in lid for smaller items
- Reinforced haul handles
- Stout rugged wheels
- Internal compression straps

Colour: Black
Size: 83 x 40 x 35cm **Capacity:** 100 litres
Weight: 4.2kg
Code F20A0062 £350.00



The oversized lid protects the main lockable zip



Made from 600D strong and water resistant TPE fabric

Guideline Large Roller Bag - 150L

An extra-large 150L, lightweight wheeled bag for longer trips and expeditions. Made from 600D strong and water resistant TPE fabric. This bag is equipped with heavy duty, wide roller wheels. The oversized lid protects the main lockable zip. Large carry and pull handles made from strong webbing on all sides. Compression straps adjust the bag to size. The simple, large internal compartment has a reflective liner for improved visibility. This is one of the largest and lightest roller bags on the market.

Colour: Grey
Size: 83 x 44 x 42cm
Capacity: 150 litres
Weight: 4.2kg
Code 14A0469 £189.99



Large main compartment with lockable YKK zip entry



Reinforced base

Integrated wheels

Lifeventure Expedition Wheeled Duffel - 120L

A large capacity, soft wheeled bag that is simple, incredibly tough and built to the highest specifications. The simplicity of its design makes it lighter than other wheeled bags.

- Large main compartment with lockable YKK zip entry
- Integrated wheels
- Top and end grab handles
- Reinforced base

Colour: Black
Size: 36 x 84 x 38cm
Capacity: 120 litres
Weight: 2.1kg
Code 12A0124 £74.99

Lifeventure TSA Zip Lock
Code 11A0355 £9.99

SPORTFISH RECOMMENDED









BAJÍO SUNGLASSES - SEE MORE, CATCH MORE

Bajío's lightweight plant-based frames feature polarized lenses with proprietary LAPIS technology, filtering out 95% of damaging blue light. The result is the clearest lenses on the planet, letting you stay on the water longer with less eye strain. Available with four lens colour options and either glass lenses for improved visual clarity and scratch resistance or polycarbonate lenses for impact resistance and lightness.

Lens Colour Options:

-  **Blue Mirror** - The darkest lens, great for off-shore fishing on the brightest days. VLT 10%
-  **Copper (Non-Mirror)** - A high contrast, general purpose lens ideal for spot ting anything under water, especially fish. VLT 14%
-  **Silver Mirror** - A medium light, high contrast lens ideal for river and lake fishing in both bright sun and lower light conditions. VLT 14%
-  **Rose Mirror** - The brightest lens, another great lens colour for lake and river fishing. This high contrast lens works well in lower light conditions. VLT 16%



Roca

A modern oversized XLarge frame with vented side shield made from moulded, lightweight durable bio-based nylon and features comfortable non-slip nose pads and rubber temple tips.



Code 22B0020

Frame Size	Frame Colour	Lens Colour	Lens Material	VLT	Price
XLarge	Tortoise	Silver Mirror	Glass	14%	£249.00
XLarge	Black	Silver Mirror	Glass	14%	£249.00
XLarge	Black	Rose Mirror	Glass	16%	£249.00
XLarge	Tortoise	Copper	Glass	14%	£249.00
XLarge	Tortoise	Copper	Poly	14%	£199.00
XLarge	Black	Rose Mirror	Poly	16%	£199.00

Rubber temple tips



Vega

Named after a legendary Yucatan guide the large, squared frame with wide temples provides perfect protection from the sun. The frames are made from moulded, lightweight durable bio-based nylon and feature comfortable non-slip nose pads and rubber temple tips.

Code 22B0021

Frame Size	Frame Colour	Lens Colour	Lens Material	VLT	Price
Large	Tortoise	Blue Mirror	Glass	10%	£249.00
Large	Tortoise	Copper	Glass	14%	£249.00
Large	Black	Rose Mirror	Glass	16%	£249.00
Large	Black	Copper	Poly	14%	£199.00
Large	Tortoise	Rose Mirror	Poly	16%	£199.00



Bales Beach

A large wrap-around style with built-in side shields for maximum sun protection. The frame is moulded from lightweight durable bio-based nylon and features comfortable non-slip nose pads and rubber temples.

Code 22B0017

Frame Size	Frame Colour	Lens Colour	Lens Material	VLT	Price
Large	Tortoise	Blue Mirror	Glass	10%	£249.00
Large	Tortoise	Silver Mirror	Glass	14%	£249.00
Large	Black	Copper	Glass	14%	£249.00
Large	Black	Rose Mirror	Glass	16%	£249.00
Large	Black	Silver Mirror	Poly	14%	£199.00
Large	Black	Rose Mirror	Poly	16%	£199.00



Nipper

A comfortable medium sized wide frame made from moulded, lightweight durable bio-based nylon and features comfortable non-slip nose pads and rubber temple tips.

Code 22B0018

Frame Size	Frame Colour	Lens Colour	Lens Material	VLT	Price
Medium	Black	Blue Mirror	Glass	10%	£249.00
Medium	Black	Copper	Glass	14%	£249.00
Medium	Tortoise	Rose Mirror	Glass	16%	£249.00
Medium	Tortoise	Copper	Poly	14%	£199.00
Medium	Black	Rose Mirror	Poly	16%	£199.00



Boneville

These medium sized frames are named after a beautiful fishing village on the Mexican/Belize border. They offer great all-round coverage and are made from moulded, lightweight durable bio-based nylon and feature comfortable non-slip nose pads and rubber temple tips.

Code 22B0019

Frame Size	Frame Colour	Lens Colour	Lens Material	VLT	Price
Medium	Tortoise	Copper	Glass	14%	£249.00
Medium	Black	Rose Mirror	Glass	16%	£249.00
Medium	Black	Copper	Poly	14%	£199.00
Medium	Tortoise	Rose Mirror	Poly	16%	£199.00

COSTA | PRO SERIES

A NEW LEVEL OF PROFORMANCE

Costa Pro Series

Along with their colour-intensifying, polarised 580° glass lens technology, Costa Pro Series have included several fishing-performance enhancing features into their bio-resin frames to help you stay out on the water even longer:

- fully adjustable and vented nose pad
- secure sticky Hydrolite™ rubber temples
- sweat management channels and eye wire drains
- upgraded hooding and side shields
- durable metal keeper slots

Four Lens Colour Options

-  **Copper Silver Mirror.** A versatile lens colour that is perfect for UK river and stillwater fishing and other environments with varying light conditions. 12% VLT
-  **Sunrise Silver Mirror.** The perfect lens colour for dusk, dawn, overcast and low light UK conditions. Great also for fish spotting. 25%VLT
-  **Green Mirror.** A high contrast lens ideal for fishing in full sun inshore and on flats. 10% VLT
-  **Blue Mirror.** The best lens for bright, harsh, full-sun situations when on a boat in deep water. 10% VLT



- FULLY-ADJUSTABLE NOSE PADS**
Ventilated nose pads are fully adjustable for a customizable fit. Designed to help reduce fogging so you see better no matter how hot it gets.
- SWEAT MANAGEMENT CHANNELS**
Help to move sweat and water away from your eyes so you can see things like fish. Or structure holding fish. Just go fish.
- IMPROVED HYDROLITE**
Hydrolite is a rubbery substance that gets stickier the wetter it gets. Our new formula is more durable and more remora-like.
- EYEWIRE DRAINS**
Designed to help keep sweat and water from pooling up inside the frame, making sure there's nothing in the way of you and your next fish.
- HOODING AND SIDE SHIELDS**
Rubber side shields keep light from leaking in and distracting you, so your focus stays fixed on finding fish.
- METAL KEEPER SLOTS**
Clip some keepers on and keep fishing instead of trying to look overboard for your Costas, which are hard to see without your Costas.





NEW

Blackfin Pro

With its polarised 580° glass lenses and a large comfortable flexible frame the Blackfin Pro is the trusted tool of the true angler.

Code 22B0022

Frame Size	Frame Colour	Lens Colour	Lens Material	VLT	Price
Large	Matte Black	Copper Silver Mirror 	580° Glass	12%	£230.00
Large	Matte Black	Sunrise Silver Mirror 	580° Glass	25%	£230.00
Large	Matte Black	Green Mirror 	580° Glass	10%	£230.00
Large	Matte Black	Blue Mirror 	580° Glass	10%	£230.00





NEW

Reefton Pro

Named after New Zealand's world-renowned fishing area these XLarge sized frames will stay put under any conditions thanks to their moulded temples and cam action spring hinges.

Code 22B0024

Frame Size	Frame Colour	Lens Colour	Lens Material	VLT	Price
XLarge	Matte Black	Copper Silver Mirror 	580° Glass	12%	£230.00
XLarge	Matte Black	Sunrise Silver Mirror 	580° Glass	25%	£230.00
XLarge	Matte Black	Green Mirror 	580° Glass	10%	£230.00



NEW

Fantail Pro

Fantail Pro is a slightly smaller, lighter version of the Blackfin Pro.

Code 22B0023

Frame Size	Frame Colour	Lens Colour	Lens Material	VLT	Price
Large	Matte Black	Copper Silver Mirror 	580° Glass	12%	£230.00
Large	Matte Black	Sunrise Silver Mirror 	580° Glass	25%	£230.00
Large	Matte Black	Green Mirror 	580° Glass	10%	£230.00







NEW

Jose Pro

Named after the legendary angler Jose Wejbe these medium to narrow fit frames with their sleek styling are at home on the beach but also perform at the highest level out on the water.

Code 22B0026

Frame Size	Frame Colour	Lens Colour	Lens Material	VLT	Price
Medium	Matte Black	Copper Silver Mirror 	580° Glass	12%	£230.00
Medium	Matte Black	Sunrise Silver Mirror 	580° Glass	25%	£230.00
Medium	Matte Black	Green Mirror 	580° Glass	10%	£230.00
Medium	Matte Black	Blue Mirror 	580° Glass	10%	£230.00





NEW

Tuna Ally Pro

Built with integral hinges and a patented ventilation system these performance fishing sunglasses won't be missing much.

Code 22B0025





Frame Size	Frame Colour	Lens Colour	Lens Material	VLT	Price
Large	Matte Black	Copper Silver Mirror 	580° Glass	12%	£230.00
Large	Matte Black	Sunrise Silver Mirror 	580° Glass	25%	£230.00
Large	Matte Black	Green Mirror 	580° Glass	10%	£230.00
Large	Matte Black	Blue Mirror 	580° Glass	10%	£230.00



SEEDEEPER™ WITH FORTIS SUNGLASSES

Fortis Eyewear are the UK's leading independent polarised sunglasses specialist. Their affordable range now offers a brand new model featuring Italian glass lenses, a technology popular with anglers who rely on clarity and performance from their sunglasses. The complete Fortis range uses various lenses and frames for all budgets with absolutely no compromise on quality. All supplied with a convenient hard case and a cleaning cloth.

Lens Colour Options:

-  **Brown 247:** All-round lens with high contrast definition, great for low to bright light conditions.
-  **Amber AMPM:** Unrivalled high contrast definition lens for low light conditions or at dawn and dusk.
-  **Green:** Superb all-day lens that maintains natural colours whilst absorbing blue light.
-  **Blue:** The darkest lens, exactly what you need for the very brightest conditions.
-  **Switch:** Photochromic lenses adapt instantly to varying light levels, so when it's sunny they darken and if it's cloudy they lighten.

Aviator

TAC lenses - Tri Acetate Cellulose (TAC)

A modern twist on a cult classic, incorporating a luxurious tortoiseshell frame or a super smooth soft touch matt black frame. These frames offer supreme comfort & classic style.



Code 23A0062

Frame Width	Frame Colour	Lens Colour	Lens Material	VLT	Price
141mm	Tortoise	Brown	TAC	13%	£34.99
141mm	Black	Brown	TAC	13%	£34.99
141mm	Tortoise	Switch	TAC	10-29%	£44.99

Bays

Designed with a 22-degree wrap angle offering great side coverage to help eliminate side light. Zero hinge (no metal hinge) also makes these frames extremely lightweight & robust.



Code 23A0064

Frame Width	Frame Colour	Lens Colour	Lens Material	VLT	Price
143mm	Black	Brown	TAC	15%	£34.99
143mm	Green	Green	TAC	18%	£34.99
143mm	Brown	Switch	TAC	10-29%	£44.99

Vistas

Designed for maximum coverage with extreme optical clarity. Packed with the latest technology, from their patented Ultra Slim Injection process to their high optical precision, extreme clarity and paramount protection.



Code 23A0070

Frame Width	Frame Colour	Lens Colour	Lens Material	VLT	Price
143mm	Black	Brown	Poly	11%	£79.99
143mm	Black	Amber	Poly	31%	£79.99
143mm	Black	Blue Mirror	Poly	10%	£79.99
143mm	Black	Switch	Poly	10-29%	£89.99



Wraps

Wrap-around design for full peripheral vision and for eliminating unwanted light. Soft rubber inserts on the frame arms reduce slippage, while a unique vent system helps prevent mist/fog build up. Flexible lightweight frames for all day comfort.

Also available in a bifocal version, featuring a +2.00 magnified segment to help you see things better up close.

Code 23A0071

Frame Width	Frame Colour	Lens Colour	Lens Material	VLT	Price
140mm	Black	Brown	TAC	15%	£24.99
140mm	Black	Amber	TAC	38%	£24.99
140mm	Black	Switch	TAC	10-29%	£34.99
140mm	Black	Brown/Bifocal	Poly	15%	£44.99

Stokes

A performance model with sleek features. Contemporary design in a classic tortoiseshell finish, the most stylish model in the range.



Code 23A0069

Frame Width	Frame Colour	Lens Colour	Lens Material	VLT	Price
136mm	Tortoise	Brown	TAC	15%	£34.99
136mm	Tortoise	Amber	TAC	38%	£34.99
136mm	Tortoise	Switch	TAC	10-29%	£44.99

Bays Life

A slimmed down classic sports frame engineered for weight reduction. A honed version of Fortis Eyewear's most popular family of sunglasses the Bays, but refined, refreshed and restyled.



Code 23A0063

Frame Width	Frame Colour	Lens Colour	Lens Material	VLT	Price
143mm	Black	Brown	TAC	15%	£34.99
143mm	Black	Amber	TAC	38%	£34.99
143mm	Black	Switch	TAC	10-29%	£44.99

Finseeker

Lightweight durable recycled TR90 nylon frames to withstand the toughest conditions. With vents to minimise internal fogging and rubber nose pads and tips on the arms to provide comfort. Spring loaded hinges to fit all head shapes and sizes.



Code 23A0066

Frame Width	Frame Colour	Lens Colour	Lens Material	VLT	Price
140mm	Black	Brown	Poly	19%	£119.99
140mm	Black	Amber	Poly	22%	£119.99
140mm	Black	Green Mirror	Poly	10%	£119.99
140mm	Black	Switch	Glass	13-27%	£159.99



Fortis Eyewear OverWrap Sunglasses

Specifically designed to fit over regular prescription glasses. Soft rubber inserts on the arms reduce slippage, whilst maximising comfort. A unique vent system at the top of the frame helps prevent mist/fog build up. Flexible lightweight frame for all day wear. Supplied with a hard case and a cleaning cloth.

Unique vent system at the top of the frame helps prevent mist/fog build up



3-Lens Colour Options

- Brown 247:** An all-rounder with high contrast definition, great for low to bright light conditions
- Amber AMPM:** Unrivalled contrast definition for low light conditions or at dawn and dusk
- Switch:** Photochromic lenses adapt instantly to varying light levels, so when it's sunny they darken and if it's cloudy they lighten

Code 23A0068

Frame Width	Frame Colour	Lens Colour	Lens Material	VLT	Price
164mm	Black	Brown 247	TAC	15%	£39.99
164mm	Black	Amber AMPM	TAC	38%	£39.99
164mm	Black	Switch	TAC	10-29%	£49.99

Specifically designed to fit over regular prescription glasses



OVERXCAST®

OverXcast Sunglasses

OverXcast is a polarised sunglass designed to be worn over prescription glasses. The sunglasses will comfortably fit over 96% of all prescription eyewear.

The frames are designed to completely isolate the eyes from the elements, blocking 100% of harmful UV rays and completely eliminating glare. OverXcast is packaged in a clear PVC pouch, featuring a popper that is easy to open and close. The lenses allow 14% light transmission and improve depth perception by increasing contrast in variable light conditions.

Designed to be worn over prescription glasses



ONLY £32.99

Blocking 100% of harmful UV rays and completely eliminating glare

Code 15A0325

Model	Frame Colour	Lens Colour	Price
M	Black	Amber Copper	£32.99
ML	Black	Amber Copper	£32.99
L	Black	Amber Copper	£32.99

ISOLATE YOUR EYES COCOONS® sunwear

OVERX Engineered to be Worn Over Prescription Eyewear

Cocoon Sunglasses

Available in 4 Sizes:



Slim Line (M)
Fits over glasses: up to 13.3 x 3.9cm



Wide Line (ML)
Fits over glasses: up to 13.8m x 3.6cm



Pilot (L)
Fits over glasses: up to 13.8 x 4.8cm



Aviator (XL)
Fits over glasses: up to 14 x 5.1cm

Code 27660

Model	Frame Colour	Lens Colour	Price
C202 Aviator (XL)	Black	Amber Yellow	£64.99
C302 Pilot (L)	Black	Amber Yellow	£64.99
C422 Wide Line (ML)	Black	Amber Yellow	£64.99
C402 Slim Line (M)	Black	Amber Yellow	£64.99

Available in two lens colours - Amber or Yellow

BEST SELLER



Polycarbonate side lenses

Permanently injected for the lifetime of the frame.

Flex2fit temples
Adjustable ear pieces for an exact fit.

360° advanced UV protection
Patented frame designs block damaging UV light and glare from all angles (top, bottom and sides) isolating the eyes in a cocoon of filtered light.

MUST BUY

Soft touch comfort
Ballistic nylon frames are finished with Soft Touch for the ultimate in durability and comfort. Every frame features a lifetime warranty.

Case and Cloth
Convenient clip-on protective case and microfibre cleaning cloth supplied with each pair of cocoons.





Clip On Flip 'n' Focus

Flip the lenses down for magnification, or flip them up and out of the way for regular vision. A must for anyone who needs readers to tie knots.

Magnification Available:

+2.0, +2.5, +3.0

Code 11457 £14.99



Snowbee Clip On +2.5 Magnifiers

Designed for anglers who only require glasses for close-up work, they fit any sunglasses and have a simple flip-up mechanism making them unobtrusive and virtually undetectable. +2.5 magnification.

Code 23A0077 £17.99



Cap-Peak Clip-on Magnifiers

This innovative device provides +2.5 magnification just where and when it's needed. When not required, it simply flips up under the peak of your cap.

Code 14A0527 £14.99

Orvis Flip Focal

Attaches to the brim of your hat and gives you 2.25 X magnification.

Great for small flies and thin leaders!

Code 10066 £20.99



Flyvines Chums Sunglasses Retainers

Handmade from recycled fly lines, Flyvines is proud to partner with Chums and offers a sunglass retainer with a secure moulded tip. Each product is braided by hand and, as such is, one of a kind. 17 inch.

Colours: Neon, Neutral

Code 19B0049 £12.99



Bajío Zip Keeper

Durable, lightweight 14 inch cord zips down to 9ins for a secure custom fit. Universal silicon ends fit most glasses.

Colours: Black, Clear or Blue

Code 22B0027 £16.99



Snowbee Prestige Streamfisher Sunglasses

A classic design with a close-fitting, wrap-around style. For improved comfort and grip they are fitted with rubberised frame arm tips and comfortable rubberised nose pads. Supplied with a clip-on protective case, cleaning cloth and glasses lanyard.

Colours:

A Black Frame/Amber Lens

B Black Frame/Yellow Lens

Code 20A0109 £25.99



Snowbee Spectre "Dry Fly" Sunglasses

A pair of specialist "dry fly" sunglasses that are specifically *non*-polarised to help dry fly silhouettes stand out against the surface of the water. They also feature polycarbonate hydrophobic yellow lenses in a comfortable lightweight polycarbonate black frame.

Code 22A0106 £29.99



Yellow non-polarised lenses

Fortis Glasses Lanyards

Comfortable and secure glasses retainers that fit any pair of Fortis sunglasses. 23 inch.

Colours: Black, Olive, Orange

Code 23A0073 £2.99



Costa Gripper Sunglass Cord with Swivel

A braided nylon cord with a Costa logo bead and a locking swivel hook attachment. 35 inch.

Code 23A0075 £6.99



Costa Bowline Silicone Retainer

Comfortable, durable 19-inch silicone retainer.

Colours: Black, Navy, Costa Blue

Code 22B0028 £8.99



Costa Keeper

Secure, soft cotton 20-inch keeper with an adjustable bead.

Colour: Blue, Black

Code 22B0029 £6.99



Costa Microfibre Cloth Pouch - Fish Blue

A storage pouch that doubles up as a cleaning cloth. Made from ultra-soft recycled microfiber.

Code 23A0074 £5.99



Fortis 3-in-1 Lanyard Cleaning Case

Clean, protect and store your valuable glasses in this convenient, all-in-one lanyard case.

Code 23A0072 £5.99



Costa Hermit Cloth - Blue

A soft microfibre cleaning cloth that fits into its own convenient silicone casing. Supplied with a secure attachment clasp.

Code 23A0076 £8.99



Costa Clarity Cleaning Kit

30ml lens cleaner with a microfibre cloth supplied in a durable carrying case.

Code 22B0030 £9.99



Glasses Cleaning Repair Kit

Compact, easy to carry pouch contains:

- Lens cleaning solution
- Microfibre wipe cloth
- 2-in-1 key chain screwdriver

Code 26594 £5.99





BARRY ORD CLARKE

Author, photographer and multiple award-winning fly tyer

FLY TYING FOR BEGINNERS

The nature of fly fishing for most of us is such that once you have taken the first step and learned to cast with a fly rod and eventually land your first fish, you gain instant membership to a very special international group that has no cultural or social boundaries. We all become members of one and the same family - fly fishers.

Our enthusiasm and hunger for knowledge within our sport and its related subjects becomes a vocation. Whenever and wherever we meet, by the water on a warm mid-summer's day or around a table on a cold winter's night, with old fishing friends or total strangers, we eagerly exchange experiences, techniques and sometimes even well-kept secrets. If you are new to our sport, you truly have something to look forward to. You may find the technical language a little difficult to begin with but it doesn't take long before you are talking in tongues. No matter where you meet a member of this family, you will always have something to talk about, with the conversation easily flowing from tackle, big fish, destinations and, finally, flies and fly tying.

The second step, and probably the most natural progression from fly fishing, is to fly tying. With the industrialisation of the production of the fishing hook and the time-consuming production of fishing flies being moved to countries with cheaper labour, the days are gone where fly fishermen tied flies out of financial necessity. As with fly fishing, there is a certain amount of equipment you 'need' to obtain, and techniques that help to be learned, before you can embark on the second lifelong journey of the fly fisher - to the fly tying bench.

Through fly tying the fly fisher can open previously locked doors and enter a whole new world of their sport, customising existing patterns to their own specific requirements, and even designing their own!

The first flies that a beginner attempts to tie are normally familiar patterns that have worked well for them. This is always a good place to start, as long as the patterns don't require any overly difficult techniques, procedures or special materials that are not easy to obtain in a sufficient quality. Frustration at this early stage can quickly lead to failure, and a danger of your fly tying kit ending-up in the attic along with the windsurfing board and golf clubs.

On the other hand, if the beginner starts their fly tying journey with a couple of fishable patterns that are technically easy but still rewarding to tie, these can be the stepping stones to more advanced and challenging patterns, with the help of which they will eventually be able to tie all the flies they require, and many more.



Vice

This is the single most expensive item you need as a fly tyer, so your choice should be made carefully. You should consider how many and what type of flies you will be tying and what size hooks you will be using. Beyond the prime function of holding the hook securely, modern vices incorporate a number of additional functions of varying usefulness. Adjustable height, jaw angle and full rotation are now standard in most models.

Tools

There are a few essential tools that you will also need:

Scissors

It's unreasonable to expect one pair of scissors to do all the cutting jobs required when tying flies. Eventually you will need two: one high quality pair with fine sharp points for all the delicate precise work needed and a second probably less expensive pair for all the heavy-duty cutting jobs of tinsel, wire etc. When buying scissors, make sure that your finger and thumb fit comfortably in the handles, so you can slip in and out of them easily and exchange them for other tools without the need for a second hand.

Bobbin holder

This is the tool that holds and dispenses your tying thread. A poor-quality bobbin holder will only result in frustration! It's worth investing in a good quality ceramic bobbin holder, which is far superior to other models.

Hackle plier

You will find it much easier to steer your hackles when wound if you use a hackle plier. They come in many designs and price ranges. I use and can highly recommend the rotary hackle model which will keep the hackle from twisting when wound. Whatever hackle plier you choose, it's important that the jaws are tight and hold even the finest hackle point.

Dubbing needle

This is the simplest tool for fly tying and the least expensive, but also one of the most useful, with many tasks to perform: applying varnish, picking out dubbing, splitting thread etc. Choose a dubbing needle with a long handle and a short needle. Ones with a long needle are impossible to use for precise work.

Materials

Once you start tying flies you will quickly understand how much easier it is to tie good flies with quality materials. Start by buying the few materials that you need to tie a handful of patterns that you will fish with. When buying materials be aware that no matter how similar they look no two natural materials are the same. Feathers and fur come from individual birds and animals whose lifestyle, geography, diet and time of year that they were culled are all contributing factors to the quality of the material.

When buying your first vice, tying kit or materials, the experienced staff at Sportfish can help you make the right decision, not only for the type of flies that you intend to tie, but also for your budget. It's also beneficial to start by learning and mastering the basic techniques, no matter how simple - once mastered they will become the advanced skills that will help you succeed, no matter what you tie. A good beginner's book and some lessons with a local club or branch of The Fly Dressers Guild will also give you valuable advice.

Barry's books and Fly-Tying Material pack for the beginner and the experienced fly tyer are available from Sportfish see page 185 and 203.

PROFESSIONAL TYING VICES



HMH vices have been satisfying the needs of professional, production, and amateur fly tyers for more than thirty years.

Their vices are precision machined from stainless and tool steels with machined brass fittings. Each vice is hand fitted and tuned for optimum performance. Everything is guaranteed for life. They don't go in for a lot of the frills you see on many vices today, instead they prefer that you spend your money on what's more important – a simple, solid, and fast tool with great jaws, that will last you a lifetime.



HMH Spartan Vice

The Spartan is probably the best value in precision machined vices today. It gives you all the performance features you'll ever need including full rotary action, adjustable head angle, & incredibly easy & versatile interchangeable jaw system.

Key Features

- Infinite head angle adjustment
- Hardened tool steel jaws
- Quick change jaw feature
- Durable chrome powder coated chassis
- Ultra-smooth 360° rotary action
- Smooth disc drag rotary tension adjustment
- Locking cam lever
- Fast, one-handed operation
- Double spring material clip
- Lifetime guarantee

Available in: Pedestal Base or C-Clamp

Code 80081 £315.00



HMH ST Vice

The HMH ST is their newest vice. It is built on a fixed-angle frame but gives you the added versatility of the famous HMH interchangeable jaw.

Key Features

- Teflon-smooth full rotary action
- Original HMH Disc-drag operation
- Precision-machined, adjusting knob
- Heavy duty cam lever (universal 3/8" diameter)
- Lifetime guarantee

Available in: Pedestal Base or C-Clamp

Code 80079 £270.00



HMH Standard Vice

Durable, simple, & beautiful. If you're looking for the comfort & stability that comes with a full size vice, not to mention dependability, speed, versatility, & tying elegance, then you can't own a better tool for tying than this vice. Each vice is individually hand fitted & tuned for maximum performance.

Key Features

- Infinite head angle adjustment
- Longest tying platform for better tying
- Hardened tool steel jaws
- Quick change jaw feature
- Hand polished stainless steel chassis
- Ultra-smooth 360° rotary action
- Smooth disc drag rotary tension adjustment
- Large, comfort-grip locking cam lever
- Fast, one-handed operation
- Double spring material clip
- Coated sculpted pedestal base, or C-clamp
- Neoprene vice pouch included
- Lifetime guarantee

Available in: Pedestal Base or C-Clamp

Code 80080 £477.00



HMH Tube Spinner Vice

HMH's dedicated, in-line rotary Tube Vice. The sturdiest & most versatile tube vice on the market, the spinner is precision machined of stainless steel, tool steel & hard anodised aluminium. Includes 3 starter pins & complete instructions.

Key Features

- Precision machined components
- Ultra smooth 360° rotary action
- Versatile, use with or without pins
- Exclusive disc drag rotary tension adjustment
- Removable spinner head
- Double spring material clip
- Lifetime guarantee

Available in: Pedestal Base Only

Code 80082 £399.00

DYNA-KING VICES



DYNA-KING, INC.
World's finest handcrafted flytying vices



Dyna-King Kingfisher

The entry level Dyna-King. Small but still with 360° rotation and 'notch lock'.

Available in:

Clamp or pedestal model

Code 25364 £259.00



Dyna-King Supreme

The best seller in the range, this vice is bigger and built for serious work. Fully adjustable head angle, 360° rotation, rotation lock and bobbin hanger.

Available in:

Clamp or Pedestal Model.

Code 13080 £379.00



VICE ACCESSORIES



Dyna-King Trim Bag

Mounts on vice stem. Easy empty design. 3" deep.

Code 13754 £49.99

HMH Profile Plate

Seeing better means tying better. Machined delrin support body with machined brass fittings. Stainless steel rod. White plate adjusts side to side, front to back, and tilts to give optimum view.

Code 80083 £43.99



HMH Bobbin Rest

Machined delrin support body and thread support. Machined brass fittings. Stainless rod is 9" long with with 4" upright. Adjustable in three directions

Code 80084 £43.99



HMH Tube Vice Converter

The Tube Vice Converter easily converts your HMH vice into an in-line rotary tube vice. Holds tubes by chucking them directly in the steel jaws. Comes with two premium mandrels, sample tubes and tube fly hook samples.

Code 11A0127 £110.99



C&F VICE



C&F Marco Polo Fly Tying System

The Marco Polo Fly Tying System is the ultimate mobile kit for the travelling fly fisherman. All tools are full size & easy to use, but engineered to fit compactly into the waterproof case.

System contains

- Marco Polo Vice
- 3-in-1 bobbin kit
- Hook pallet
- CFT60 bobbin holder with thread
- CFT90 3-in-1 hair stacker with hair comb
- CFT100 dubbing twister plus
- CFT110 2-in-1 whip finisher
- CFT120 hackle plier
- Pair of TS tying scissors

Code 25171 £489.00

WOLF INDIANA VICES



Wolf Indiana Atlas Vice

The Atlas Vice has all the features you could ever want at an affordable price. Genuine full rotary function with adjustable jaws for hook sizes from 28 to 6/0. Stainless steel construction with hardened steel jaws. Supplied with a pedestal base.

Key Features

- Full rotary function
- Smooth rotation on precision bearings
- Hooks from size 28 to 6/0
- Stainless steel construction
- Supplied with a pedestal base
- Limited lifetime warranty

Code 11A0128 £259.00

Wolf Indiana Apex Vice

The Apex Vice sets new standards in quality, usability and value for money. Features in-line 360° jaw rotation for inspection and trimming. Hardened steel jaws with grooves hold all hooks from size 32 to 6/0. One step hook placement. Fully adjustable tilting head with material spring. Stainless steel construction. Supplied with a pedestal base.

Key Features

- In-line 360° jaw rotation
- Hooks from size 32 to 6/0
- Stainless steel construction
- Supplied with a pedestal base
- Limited lifetime warranty

Code 11A0129 £199.99

STONFO VICES



Stonfo Kaimen 609 Vice

The Kaimen is a high technology vice for a fast hook change. To use, simply squeeze the lever and drop the hook into the jaw. The hook will be held solidly in the vice, with no adjustment. The hardened steel jaw is designed to cover hooks ranging from a tiny size 28 to a mighty 5/0. The lever can be set up for both left and right handed use. Supplied with pedestal base, spring material clip, allen keys and instruction manual.

Key Features

- 360° rotary action with dual precision ball bearings
- Adjustable rotary tension
- Locking knob 0°-180°
- Head angle, height & tying angle adjustment

Code 15A0080 £234.00



Stonfo Transformer 3 in 1 Kit

The Transformer is a high technology product which, thanks to a fast-coupling device on the shaft, can be transformed from an in-line vice to a tube-fly vice or a streamer vice. Three vices in one with just a click. The stainless steel shaft is in-line full rotary by dual precision ball bearings. All parts of three vices are included with the Transformer. The new steady pedestal base has a useful integrated tool rack. Other important Transformer features: interchangeable jaws, adjustable rotary tension, smooth rotary motion, locking position at any angle, shaft fast locking every 45° angle, adjustable height, reversible for left hand tying. Other accessories included: rounded shape bobbin cradle, parachute plier, adjustable spring material clip, pivot thread cradle, allen keys and instruction manual.

Code 16A0136 £448.00



Stonfo 653 Elite Vice

High quality in-line 360° rotary action vice for tying flies and streamers. The stainless steel shaft rotates on precision ball bearings. The shank of the hook rotates on axis thanks to the adjustable shaft. The steady pedestal base has a useful integrated tool rack. Other important features: interchangeable jaws, hook locking by "super soft" lever device, adjustable rotary tension, smooth rotary motion, locking position at any angle, adjustable height, reversible for left hand tying. Other accessories included: rounded shape bobbin cradle, parachute plier, adjustable spring material clip, pivot thread cradle, allen keys and instruction manual.

Code 23A0078 £326.00

VALUE VICES

Super AA Vice

Fully adjustable lever operated vice.

Code 13078 £12.99



Midge Heads

Made with hardened jaws, these heads will fit into the head of all the vices listed.

Code 13079 £5.99



Sportfish Travel Vice

This very compact lightweight vice is ideal for taking on trips away from the comfort of the home tying bench. Clamp Base. Supplied in its own Cordura bag.

Code 90336 £21.99

TUBE FLY ATTACHMENTS



HMH Tube Fly Tool

A superb tool for holding tube flies in any vice. It adjusts to any tube fly length from 0.6-7.6cm. 2 different diameter pins are included to suit different tube bores.

Code 13085 £47.99



Tube Fly Vice Adapta

A simple piece of kit that will make the job of tying tubes much less stressful. Comes with 3 different needles to accommodate large & small bore tubes.

Code 26606 £8.89



Frodin F.I.T.S Tube Needle

Tapered needle, made from carbon steel. Compatible with any make and style of vice.

Code 80381 £21.99

Rotatable Vice

Sprung lever action jaws. Fully rotational jaws & head.

Code 13076 £29.99



Super II Vice

Lever action vice. Full barrel rotation with hook in vice.

Code 13077 £19.99



Veniards Waste Bag

A very handy bit of kit for all your waste bits. Simply attaches to the vice stem.

Code 80038 £9.99



Stonfo Sight Board

A white sight board that rotates through 180° & becomes a back sight board.

Code 12A0119 £28.49

FLY TYING MAT

Loon Fly Tying Mat

An easy clean silicone mat that is the ideal solution for keeping all your tools and materials tidy and close at hand.

4-magnetic compartments keep beads and hooks secure.

Size: 25cm x 40cm

Code 23A0107 £37.99



SCOTTIE VICE



The Scottie Vice

Easy to use and Reliable Clamp Version

Handmade in the UK for those who tie lots of flies. Just squeeze the handle and place the hook and it will never move, no adjustments needed!

Code 60190 £92.49



Scottie Reflector Plate

This simple but effective background fits onto all Scottie vices and can be easily positioned to work on your fly or swung out of the way when not required.

Code 60198 £21.49

FLY TYING BAGS



Pedestal insert with Velcro® tie-downs and 20 spool inserts

Fishpond Tailwater Fly Tying Kit Bag

A great travel and organisation solution for all keen fly tyers. Four large see-through mesh pouches and a padded storage compartment provide space for materials including for long, delicate capes. Includes tool station and spool tray to protect your scissors and other items and space to secure a heavy pedestal base.

- Exterior quick access pocket and four large see-through mesh material pockets
- Pedestal insert with Velcro® tie-downs and 20 spool inserts
- 38 x 23cm padded pocket for vice heads and delicate materials
- Removable 38 x 24cm tying pad with 4 built-in dishes for hooks or beads

Size: 41 x 20 x 26cm Colour: Tan

Code 21A0094 £229.00

LAMPS & MAGNIFIERS



Combination LED Tying Lamp with Magnifier - 2X and 4X

An ultra-bright (220 lumens) LED daylight bulb with a 60° beam to reduce eyestrain, together with a 2X general and a 4X spot magnifying lens. The heavy base, optional clamp and the 18" flexible arms make this a useful bit of kit for any fly tyer.

Code 11A0336 £179.99



OffLite Crane Light & Magnifier

The ultimate tool for the serious fly tyer. The 22w Clamp Magnifier brings the best in OffLite illumination combined with an optical-grade magnifier. The sturdy and versatile clamp attaches to desks, workbenches, tables, and much more. Features an articulating arm and rotating head with 360° illumination for precise viewing and angle placement. Flip shade closes to protect the magnifier when not in use. Rotating head with 1.75x optical-grade magnifier (5" dia) and 360° illumination bulb included. Rated to last up to 10,000 hours.

Code 18A0517 £99.99

FLY TYING KITS AND BOOK

Fly Tying for Beginners Book

In this exceptionally clear and easy-to-use beginner's guide Barry shows you exactly how to create a dozen universal fishing flies, step-by-step. Each of the 12 patterns is linked by QR code to a YouTube video showing Barry tying the fly in question. Hard cover. 127pgs

Code 21B0046 £14.99



Barry Ord Clarke's Fly Tying Material Pack

This fly tying kit contains everything you need to tie the patterns in Barry Ord Clarke's Fly Tying for Beginners Book. To see a list of the pack contents, please see our website www.sportfish.co.uk.

Code 22B0048 £96.99

Veniard's Pinnacle Fly Tying Kit

A comprehensive fly-tying kit containing all the materials, threads, tools, hooks and a vice that you need to tie hundreds of different flies. Packed in the superb quality Zenith Box with 3 top compartments, a large compartment under the lid and 4 interchangeable divided drawers which are held in place by 2 hinged half doors. Please visit www.sportfish.co.uk for a full list of all the materials included. **Size:** 1.6 x 2.2 x 12.0cm

Code 10274 £199.99

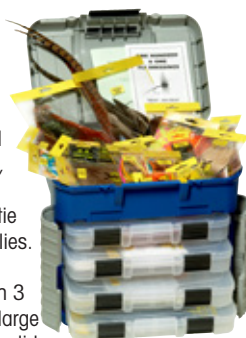

Premium Fly Tying Kit

This kit contains a plethora of materials. There is enough in the kit to satisfy the keen beginner & expert tyer alike. There is a basic set of hooks & tools, and also a vice included.

Code 13110 £75.49



Turrall's Fly Tying Kit

An ideal gift for any fly tyer. The kit contains a vice, tools, hooks and a bundle of material.

Code 11A0346 £64.99



FLY TYING TOOL SETS



Gold Loop Tool Kit

A smart set of high quality tools consisting of Gold Loop Scissors, Rotary Whip Finish Tool, Bobbin Holder with ceramic inserts, Dubbing Needle and Hackle Pliers.

Code 23A0085 £16.79



Titanium Coated Fly Tying Tool Kit - 6pcs

Titanium coated tool kit which includes premium scissors, dubbing needle, rotary whip finish tool, hackle plier, ceramic-lined bobbin holder and bobbin threader.

Code 21B0083 £29.99



Stonfo Fly Tying Tool Kit - 6pcs

Complete travel kit supplied in a strong, elegant case whose rubber interior is shaped to give each tool a home. The 8-piece kit includes: small scissor, Bobtec1 bobbin with adjustable thread tension, bobbin threader, conical finisher, bodkin, hackle pliers, roto dubbing mini and pettine comb.

Code 20A0108 £109.99



Loon Core Fly Tying Tool Kit

This quality 5-piece kit from Loon contains the 5 essential core items for your fly-tying bench: scissors, bobbin, bodkin, whip finisher and hackle pliers all packed neatly and securely in a heavy-duty travel case.

Code 20B0067 £59.99

STONFO TYING TOOLS



Stonfo Elite Bobbin Rest/Parachute Tool

A very versatile bobbin rest/parachute arm, the clever S bend means it is always in the right position without being in the way. Stainless steel and adjustable to multi position. Fits vice stems 0.8-1cm. Vice not included.

Code 15A0308 £49.99

Stonfo Elite Roto-Dubbing Tool

Superior quality dubbing tool made from stainless steel with a ball bearing that allows for a fast and smooth rotation. Its swinging head allows 90° of free swinging motion with a stop lock at its centre position. Comes with complete instructions.

Code 15A0311 £49.39

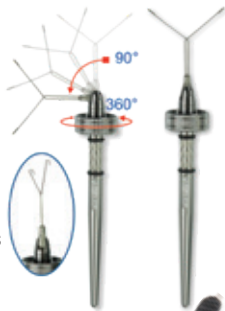

Stonfo Pettine Comb (Dubbing Rake/Teaser)

A great little tool from Stonfo, combines a comb and Velcro® brush. Great for combing out hair or teasing dubbing.

Code 15A0314 £6.79



Stonfo CDC Block

A block with grooves of different length to easily fold the feathers. You just have to insert the quill of the feather inside the groove of the right length. Equipped with three antiskid rubber feet. We suggest to use the CDC Feathers Block in combination with the Stonfo Hair Clips to work more easily on the feathers.

Code 23A0079 £8.99



Stonfo Thread Cutter

A tool equipped with a special V-blade that allows to cut the thread quickly and accurately. At the other end, the tool is equipped with a short and sharp stainless steel needle.

Code 23A0080 £11.39



Stonfo Bobtec 1

This stainless steel bobbin holder has a slider to adjust the thread tension. The tube has a strong hardened steel bush to prevent the thread fraying. Perfectly balanced when rotating makes it ideal for creating a split thread dubbing loop.

Code 17A0501 £22.89

Stonfo Bobtec 2

As above but with a wider tube

Code 17A0501 £22.89

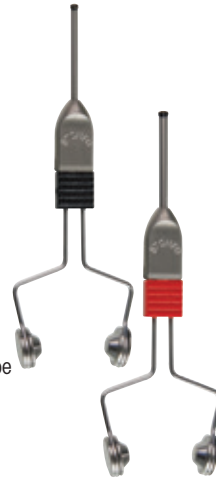

Stonfo Hackle Plier

A great little hackle plier with a push and grip style plier.

Code 12A0113 £9.99

Stonfo Elite Whip Finish Tool

Extra user-friendly whip finisher tool. Ergonomic, well balanced and superb quality. Made on high precision machines from stainless steel

Code 15A0309 £19.59



Stonfo Hair Stacker

Heavy hair stacker with rubber bottom. Aligns hair for tails and wings perfectly. Supplied with two different sized tubes.

Code 15A0312 £11.79



Stonfo Dubbing Hair Clip

The Stonfo Clips are great for making dubbing loops using all sorts of hackle and hair. Made from strong clear plastic material. The locking surfaces have a slight roughness to allow a perfect clamping of the fibres. 2 clips per pack.

Sizes: Small 2.8cm or Medium 4.9cm

Code 15A0081 £12.59



MARC PETITJEAN



Petitjean Magic Tool Set

An indispensable tool for every fly tier allowing you to tie all kinds of flies and to use many different components very easily at the same time. Supplied with three table clips, two clamps, three wooden dowels and full instructions.

Code 22A0092 £47.39

Stonfo Elite Bobbin Holder

A top quality weighted stainless steel bobbin holder with quick adjusting disc drag system which allows for perfect thread tension with a hardened steel tube to prevent fraying.

Code 12A0114 £18.59

Stonfo Elite Bodkin/Dubbing Needle

Extra user-friendly dubbing needle. Made on high precision machines from stainless steel.

Code 15A0310 £14.89

Stonfo Dubbing Twister

High quality revolving dubbing tool. Very small dimensions. Instructions included.

Code 15A0313 £9.89

Stonfo Bobbin Threader Type 1

Useful tool for threading of the bobbin with a hook type end. The soft touch handle is specially designed so that the tool will not roll off the tying table. Instructions included.

Code 15A0315 £4.79

Stonfo Bobbin Threader Type 2

Useful tool for threading of the bobbin with a wire loop type end. The soft touch handle is specially designed so that the tool will not roll off the tying table. Instructions included.

Code 15A0337 £4.79



RITE BOBBIN

Standard Bobbin

Perfect tension adjustment. Simply turn the wheel on the side of the bobbin to alter the tension of your thread.

- Ceramic thread tube
- Solid brass arm
- Precise click drag adjustment

Code 13032 £34.99

Cermag Bobbin

- Longer reach with 2½" ceramic insert
- High pressure click drag system
- Heavy duty thread tension 2-16 oz
- Perfect for larger flies and for spinning deer hair

Code 13032 £62.99

Shortie Bobbin

This bobbin has a 1" shorter stem, making it ideal for use with pedestal vices.

Code 13032 £34.99

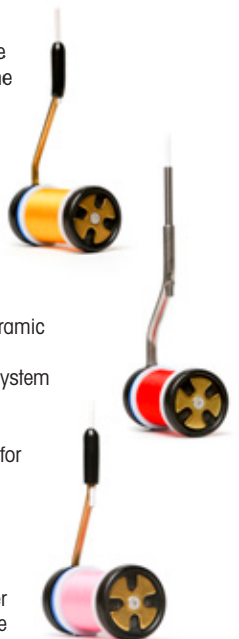

STANDARD FLY TYING TOOLS**Bobbin Holders**

1 Heavy Spigot Ceramic Tube Ceramic super smooth tube protects even the finest thread.
Code 60394 £10.99

Heavy Spigot Standard Metal Tube
Accommodates all spool sizes & has a heavy spigot for extra weight.
Code 60390 £2.99

2 Light Spigot For all spool sizes & is lightweight.
Code 60391 £2.99

3 Small Spigot Specifically designed for small spools & ultra-light tensioning.
Code 60392 £2.49

4 Brass Thumb Designed for all spool types, complete with easy hold brass plate.
Code 60489 £2.99

General Tools

5 Bobbin Threader
Makes threading your bobbin so much easier.
Code 60393 £1.99

6 Dubbing Needle Apply your varnish accurately.
Code 60395 £2.49

7 Dubbing Spinner It is the most stable and kicks around less when twirled.
Code 60396 £4.99

8 Hackle Guard - English Helps protect hackles.
Code 60398 £1.99

Hackle Pliers

9 Hackle Pliers - Small Short Nosed
Designed for small flies with small hackles.
Code 60403 £1.99

10 Hackle Pliers - Medium Long Nosed
For larger flies & longer hackles.
Code 60405 £2.49

11 Hackle Pliers - Large Short Nosed
Easy grip but designed for small hackles.
Code 60406 £2.49

12 Hackle Pliers - Ezee Ingenious design, holds the most delicate of hackles without slipping.
Code 60408 £2.49

13 Hackle Pliers - Non - Skid
Lightweight & silicone non-slip tips.
Code 60413 £1.99

14 Hackle Pliers - Rotatable
Easy to use hackle plier that eliminates twist.
Code 60425 £3.49

Hair Stackers

15 Hair Stacker - Standard
For smaller salmon & trout patterns.
Code 60427 £4.99

16 Hair Stacker - Large
Longer tube to accommodate longer lengths.
Code 60427 £5.49

Material Holders

17 Material Spring
Keeps material safe & tidy whilst tying.
Code 60429 £1.49

18 Mini Needle Nosed Pliers
A million different uses for the fly tyer.
Code 60430 £3.99

Scissors

19 Scissors - Midge
2.4" for small flies.
Code 60487 £3.49

20 Scissors - Standard Straight
3.5" long, basic fly tyer's scissors.
Code 60387 £3.99

21 Scissors - Iris 4.5" fine tapered blades.
Code 60388 £3.99

22 Spring Scissors
Open frame with a long arm spring.
Code 60389 £5.49

Tweezers

23 Tweezers - Straight
Multi purpose use with a fine point.
Code 60431 £2.99

Whip Finishing Tools

24 Standard Large
The best all-rounder for larger flies.
Code 60441 £2.99

25 Deluxe Handle stays static whilst head rotates.
Code 60454 £3.99

26 Rotatable Similar action to the deluxe but a different shaped head.
Code 60461 £4.99

27 Wing Cutters Accurately cuts wings to your chosen size. Set of 3 sizes.
Code 60438 £4.99

28 Gallows Tool
The ultimate parachute attachment.
Code 60397 £7.49

Sportfish Premier Tool Kit

A great kit to get you started in fly tying. Includes Gold Loop Arrow Scissors, Lightweight Bobbin Holder, Dubbing Needle, Non Skid Hackle Pliers, Bobbin Threader, Standard Hair Stacker & Rotating Whip Finisher.
Code 27693 £19.99

SAVE £9.44**SPORTFISH SCISSORS & TWEEZERS****Sportfish Gold Loop Scissors**

The finest scissors made from top grade stainless steel with the gold loops denoting surgical quality.

1 Arrow Scissors

Narrow blades, 1 with micro serrations for delicate precise cuts. Notch in base of blades for cutting tougher items.
Size: 3.5"

Code 60499 £9.99**2 Bent Shaft Scissors**

Narrow blades, 1 with micro serrations. Bent to make them easier to pick up off the tying bench.

Size: 3.5"**Code 60517 £9.99****3 Extra Fine Tip Scissors**

The finest scissor tip in the world for cutting individual filaments in the tightest situations.

Sizes: 3.5" or 5.5"**Code 60528 £13.99****4 Spring Scissors**

Fine tip scissors which close simply by squeezing the spring loaded arms. No loops to contend with.

Size: 4.5"**Code 60529 £9.99****5 Sportfish Razor Scissors**

As sharp as a razor.

Sizes: 4" or 5"**Code 60522 £19.99****6 Iris Scissors**

A very popular design of fine tip scissors, one blade with micro serrations.

Size: 3.5"**Code 60558 £9.99****7 Universal Scissors**

Strong scissors for cutting tougher materials including hair. 1 blade with micro serrations.

Size: 4"**Code 60563 £9.99****8 Mantle Tip Tweezers**

Longest tips.

Code 60564 £9.99**Sportfish Tungsten Carbide Scissors**

These scissors are identical to the Gold Loop which makes them very hard wearing indeed. If you do a lot of fly tying then the additional investment will repay itself. The black loops identify these scissors as tungsten carbide.

9 Arrow Point Scissors**Size: 3.5"****Code 60580 £17.99****10 Universal Scissors****Size: 4"****Code 60582 £16.99**

FLY TYING TOOLS

C&F FLY TYING TOOLS

Non-slip grips and pearl chrome finished.

1 CFT100 Dubbing Twister Plus

Unique core clip adds more character to the dubbing brush.

Code 25167 £19.99

2 CFT70 3-in-1 Dubbing Brush

Angled needle for delicate work. Half hitch tool. Stainless dubbing brush.

Code 25176 £26.99

3 CFT130 Rotary Twister Plus

Quality ball bearing dubbing twister. Thumb wheel spinner.

Code 25173 £44.99

4 CFT90 3-in-1 Half Hitcher

3 sizes of half hitcher combined in one body.

Code 25177 £22.99

5 CFT110 2-in-1 Rotary Whip Finisher

Magnet on end is useful for picking up hooks.

Code 25174 £29.99

6 CFT140 Rotary Hackle Pliers

Built in shock absorption.

Code 25172 £39.99

7 CFT120 Hackle Pliers

Flared nose to minimise risk of cutting hackles.

Code 25169 £34.99

8 CFT60 Standard Size Bobbin Holder

Optimum bobbin weight (17g) helps keep tension on material during tying. Teflon coated bobbin arms. Complete with bobbin threader.

Code 25165 £39.99

9 CFT80S 2-in-1 Hair Stacker

Double tube design adjusts to the amount of hair. Comes with hair comb.

Code 25175 £44.99



C&F Salmon/Saltwater Bobbin Holder

Designed for saltwater and specimen fly tyers. The SW Bobbin holder has increased weight to hold materials in place and features a thread tension adjustment via the side-brake.

Code 14A0406 £49.99

C&F CFT01 Bobbin Rings

- Clear rings to keep spooled materials from unwinding
- Three sizes to fit all spool sizes
- Perfectly balanced handling

Code 25166 £7.99

C&F Fly Wheel

Lightweight rotary fly drier with micro slit foam. Collapsible for easy transport & storage. Runs on 3 AA batteries (not included).

Code 90311 £54.99

C&F Rotary Tool and Bobbin Stand - CFT 175

The perfect rotary tool stand for storing all your fly tying tools and thread bobbins. The tool foam spins for easy access and your thread bobbins can be stored on three bobbin shafts. (Tools not included).

Code 19A0119 £59.99

TOOL BAR



Stonfo Tool Bar

Made from anodised aluminium with 15 various holes that allow storage of and access to most fly tying tools. With an adaptor bush for vice stems from 8 to 10 mm.

Code 17B0071 £34.99

FLY TYING DISPLAY SET

Snowbee Fly Tying Display Set

Great little kit for drying varnished flies and for those who like to photograph their creations. Consists of a clear box with foam for fly storage and 10 coloured fly hooks/hackle pliers.

Code 19A0079 £17.99



SMHAEN TOOLS

Smhaen Tungsten Carbide Scissors

Top quality tungsten carbide micro serrated scissors.

Options:

A 4" Straight Blue Midge **£34.39**

B 4½" Straight Regular Red **£36.59**

C 5" Straight Large Green **£36.59**

Code 23A0082



Smhaen Professional Bobbin Holder

A modern Danish well balanced bobbin holder that delivers maximum thread control thanks to its one finger micro adjustable tension and ceramic tube.

Colours: Standard Red, Midge Blue
Code 18B0078 £60.29



Smhaen Half Hitch Tool

A beautifully balanced half hitch tool with an integrated spring-loaded safety cutter. Just finish your fly with the half hitch tool and then trim your thread with the cutter.

Colours: Standard Red, Midge Blue, Large Green

Code 18B0079 £29.69

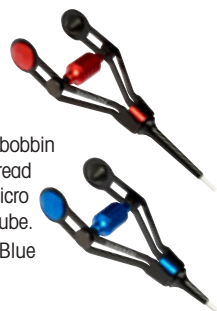

Smhaen Master Dubbing Twister

A very nicely balanced dubbing twister, perfect for when you're using a dubbing loop.

Colour: Blue Midge

Code 23A0081 £32.29



Smhaen Classic Bobbin Holder

A highly engineered, perfectly balanced ceramic bobbin holder similar to the Smhaen professional but without the adjustable tension facility.

2 Sizes: Red/Standard or Blue/Small
Code 21A0095 £40.49



VARNISH



Loon Hard Head Fly Finish

A polyurethane based formula for building colourful, glossy heads & bodies. A great alternative to epoxy. Dries in 1 hour. Supplied with applicator.

Colours: Clear, Black
Code 90312 £8.99

Loon Soft Head Fly Finish

Builds head & bodies. Soft, pliable but durable. Dries to a workable tack in 20 minutes, & cures fully in 24 hours. Supplied with applicator.

Colour: Clear
Code 90314 £8.99

Loon Hard Head Thinners

Water based thinner for use with Hard Head.

Code 90315 £6.99

Loon UV Coloured Fly Finish

The fastest and easiest way to add colour to a fly. Cures with any UV light instantly adding colour. Also perfect for heads and hotspots.

0.5oz/15ml
Colours: Hot Red, Hot Orange, Hot Yellow
Code 20B0070 £18.99

Hard As Nails

A super tough varnish reinforced with nylon. Makes super tough fly heads. 13ml bottle.

Code 13423 £7.99

Veniards Varnish

Celluloid varnish. 15ml bottles.

Colours: Clear, Black, Red
Code 13421 £2.99

Varnish Thinners

Thinners to use with the above varnish. 15ml bottles.

Code 13421 £2.59

Veniard's UV Reflective Coating

Perfect for adding a UV effect to bugs, fry patterns, etc.

Code 17A0503 £6.19

Veniard's Brush on Varnish

Brush on, quick drying, clear varnish. Great for coating buzzers. 15ml bottle.

Code 20A0155 £3.19



WAXES

Veniard's CDC Oil

The natural floatant for Dry flies. A drop on the fly will protect it from fish slime. Supplied in a handy dispenser.

Code 90339 £5.69

Veniard's CDC Gel

The natural floatant for all CDC flies, thicker than oil, this works like a barrier cream.

Code 80085 £5.69

Veniard's Liquid Wax

Specially produced by Veniard's own recipe. A drop of this along any thread will make dubbing very easy.

Code 14A0436 £3.39

Prepared Fly Tyler's Wax

Hard block wax, ideal for all dubbing applications.

Code 90317 £1.89

BT's Dubbing Wax

Formulated by Al Beaty. Super tacky wax for size 10 flies & larger

£9.39

Tacky wax for size 12 flies & smaller

£9.39

Code 14A0437

Floo Gloo Head Cement

A clear flexible lacquer which prevents feathers spilling.

Code 10002 £4.29

Watershed

Provides a permanent waterproof coating on flies, material, dubbing, yarn & even nylon leaders. An amazing waterproofing agent.

Code 90318 £7.79

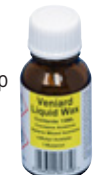

APPLICATORS

Varnish

Applicator Bottle

A fine tube for dispensing small amounts of varnish to fly heads.

Code 13425 £4.19

Glass Jar

1oz bottle with aluminium bodkin & stainless steel needle mounted in a poly-seal cap.

Code 90319 £5.49



RESIN & LIGHTS

Semperfli UV Torch - USB Rechargeable

A super-bright and consistent UV torch that is USB rechargeable. Features Cree LED bulb with 365nm wavelength and 3 watts power. The long-lasting lithium battery is recharged via the inbuilt USB port.

Size: 1.6 x 2.2 x 12.0 cm
Code 20A0161 £38.99

Gulff Pro UV Light

The 365nm wavelength UV flashlight is the best for UV resin curing, it sets resin in a few seconds and comes with a 1 year guarantee. Package contains a flashlight, USB charger and rechargeable battery.

Code 18A0143 £44.99

Loon UV

Nano Light

Small yet powerful UV light, perfect for curing fly tying UV resins and Loon's Knot Sense and Wader Patch. Uses 1 AAA battery (included).

Code 19A0026 £21.99

BUG-BOND™ Professional UV Light

The ultimate battery powered UV flashlight for curing BUG-BOND™. A lightweight aircraft grade aluminium body with type III anodising protects the single Cree UV LED that's powered by a single AA battery (battery not included). Deep quick curing with this light keeps BUG-BOND™ at the cutting edge of light curing in fly tying.

Code 10325 £29.99

BUG-BOND™ Kit

BUG-BOND™ has been designed to be tack-free & optically perfect when cured correctly. The kit includes: 20ml bottle of Original BUG-BOND™ UV Cured Resin, Multi UV LED Torch.

Code 10325 £27.79

Loon UV Clear Fly Finish

Can be used as an adhesive for eyes, a thick head cement, quick-building clear backs for shrimps, or instant repair of damaged flies.

Code 19A0080 £18.99



Gulff UV Resin

Quality, quick-drying, tack-free UV fly tying resins. Available in clear and many coloured options.

Clear Options:

Clear Thin 15ml,
Clear Classic 15ml or 50ml,
Clear Fatman (thicker) 15ml
15ml £19.99
50ml £39.99

Ambulance Coloured Options:

Glow in the dark and in sunlight.
Orange, Red, Chartreuse, Pink.
Coloured 15ml **£16.99**

Code 18A0142

BUG-BOND™ Original

BUG-BOND™ (Original-Clear) is supplied with an applicator which allows you to apply small amounts & work this with a bodkin to get the desired effect & then cure, this can take as little as 5 to 10 seconds. Large amounts of resin in saltwater baifish patterns can take longer to cure. A great feature of BUG-BOND™ is that it will not yellow on exposure to sunlight, in fact strong sunlight will deepen the cure further.

Code 10325 £17.19

BUG-BOND™ Lite

A thinner version of the Original which makes a great alternative to head cements & varnish.

Code 10325 £17.19

BUG-BOND™ Pro Tip Kit

This includes a replacement bottle top & 5 UV shielded taper tips which allow a more precise application of the fluid.

Code 10325 £4.79

Betfor UV Resin

Easy to use and great value clear UV resin. Supplied with two nozzles, 15ml squeezable tube.

3 Options: Thin, Medium or Thick
Code 21A0088 £5.99



PARTRIDGE TROUT HOOKS

PARTRIDGE
OF REDDITCH



Dry Fly Supreme - L5A

Standard wire & length. Forged round bend, wide gape. Down eye. Bronze.
Sizes: 10, 12, 14, 16, 18, 20, 22, 24
Qty 25 **£4.49** Qty 100 **£13.49**
Code 14A0209



Wet Heavy Supreme - G3A/L

Conforms to international rules. 2X Heavy wire, sproat bend. Down eye. Bronze.
Sizes: 6, 8, 10, 12, 14, 16
Qty 25 **£4.49** Qty 100 **£13.49**
Code 14A0211



Caddis Emerger - K14A

Standard wire and barbed with a straight eye. Bronze. Qty 25
Sizes: 10, 12, 14, 16, 18
Code 21B0065 £4.49



Standard Dry Fly - SLD2 - Barbless

Standard wire and barbless with a beaked point. Black Nickel. Qty 25
Sizes: 10, 12, 14, 16, 18.
Code 21B0067 £4.49



Fine Dry - SLD - Barbless

Lightweight dry fly hook with beaked point. Down eye. Black nickel. Qty 25.
Sizes: 10, 12, 14, 16, 18
Code 14A0214 £4.49



Spider - L3A/S

The perfect shaped hook for the perfect classic North Country spider & other soft hackle river flies. Captain Hamilton bend, fine-wire wet fly hook with a bronze nickel finish. Qty 25
Sizes: 12, 14, 16
Code 12A0097 £4.49



Sproat Wet - G3A

Heavy wire and barbed with a down eyed and a sproat bend. Bronze. Qty 25
Sizes: 8, 10, 12, 14
Code 21B0066 £4.49



Grub and Buzzer - K4AY-SE - Barbless

Standard wire and barbless with a straight eye. Black Nickel. Qty 25.
Sizes: 10, 12, 14, 16, 18
Code 21B0068 £4.49



Ideal Dry - SUD - Barbless

Designed for lightweight dry flies. Barbless, straight point, down eye. Black nickel. Qty 25.
Sizes: 12, 14, 16
Code 26616 £4.49



Klinkhammer Extreme - 15BNX

A short straight shank for the parachute and extreme kink for body. Qty 25.
Sizes: 8, 10, 12, 16
Code 20069 £4.49



Grub Shrimp Down Eye - K4A

Micro-barb with no offset. Down eye. Bronze. Qty 25.
Sizes: 8, 10, 12, 14, 16, 18
Code 14A0212 £4.49



Wide Wet - PWW - Barbless

Standard wire and barbless with a wide gape. Black Nickel. Qty 25.
Sizes: 8, 10, 12, 14
Code 21B0069 £4.49



Czech Nymph - CZ - Barbless

Curved shank, offset point, barbless. Black nickel. Qty 25.
Sizes: 12, 14, 16, 18
Code 26618 £4.49



Klinkhammer Original - 15BN

Klinkhammer design. Black nickel. Qty 25
Sizes: 10, 12, 14, 16, 18
Code 26610 £4.49



Longshank Streamer - D4AF

Long shank, wide gape. Down eye. Bronze. Qty 25.
Sizes: 4, 6, 8, 10
Code 14A0213 £5.49



Wide Gape Jig - SLJ - Barbless

Inline eye with a short shank and a wide gape. Barbless. Black Nickel. Qty 25
Sizes: 10, 12, 14, 16, 18
Code 21B0070 £5.99

KAMASAN TROUT HOOKS

KAMASAN



B-100 Shrimp & Buzzer

Short shank, loop bend, forged.
Sizes: 10, 12, 14, 16
Qty 25 **£4.19** Qty 100 **£13.99**
Code B100



B-100G Gold Shrimp and Buzzer

Same as B100 but in gold.
Sizes: 10, 12, 14, 16
Qty 25 **£4.19** Qty 100 **£15.99**
Code B100G



B-100N Nickel Shrimp and Buzzer

Short shank, loop bend, forged.
Sizes: 10, 12, 14, 16
Qty 25 **£4.19** Qty 100 **£13.99**
Code B100N



B-110 Shrimp & Buzzer Heavy

Heavy duty version of the B-100.
Sizes: 10, 12, 14, 16
Qty 25 **£4.19** Qty 100 **£13.99**
Code B110



B-160 Buzzer, Grubs & Shrimps

Sproat, down eye, short shank.
Sizes: 8, 10, 12, 14
Qty 25 **£4.19** Qty 100 **£13.99**
Code B160



B-170 Wet & Dry

Sproat, down eye. Bronze.
Sizes: 10, 12, 14, 16
Qty 25 **£4.19** Qty 100 **£13.99**
Code B170



B-175 Wet Nymphs

Sproat, down eye, extra strong.
Sizes: 8, 10, 12, 14, 16
Qty 25 **£4.19** Qty 100 **£13.99**
Code B175



B-200 Deep Water Nymph

Forged, very strong wire.
Sizes: 8, 10, 12,
Qty 25 **£4.19** Qty 100 **£13.99**
Code B200



B270 Wee Doubles

Down eyed, 3X strong, bronzed.
Sizes: 8, 10, 12, 14
Qty 10 **£6.49** Qty 100 **£49.99**
Code B270



B-400 Emerger

Round bend, down eye, forged.
Sizes: 10, 12, 14, 16
Qty 25 **£4.19** Qty 100 **£13.99**
Code B400



B-401 Whisker Barb

Special round bend for dry flies.
Sizes: 12, 14, 16, 18
Qty 25 **£4.19** Qty 100 **£13.99**
Code B401



B-405 Subsurface

Loop bend, light wire, slight up eye.
Sizes: 10, 12, 14, 16
Qty 25 **£4.19** Qty 100 **£13.99**
Code B405



B-420 Sedge

Loop bend, light wire, slight up eye.
Sizes: 8, 10, 12, 14, 16
Qty 25 **£4.19** Qty 100 **£13.99**
Code B420



B-440 Trout Dry

Round bend, forged, extra short.
Sizes: 10, 12, 14, 16
Qty 25 **£4.19** Qty 100 **£13.99**
Code B440



B-800 Lures, Streamers, Nymphs

Round bend, forged, 4 ex-long.
Sizes: 6, 8, 10, 12, 14
Qty 25 **£4.19** Qty 100 **£14.99**
Code B800



B-830 Lures, Mayflies, Nymphs

Round bend, long shank.
Sizes: 8, 10, 12, 14
Qty 25 **£4.19** Qty 100 **£13.99**
Code B830

AHREX HOOKS

FW502/503 - Dry Fly Light
A lighter version perfect for light and delicate dry flies. Chemically sharpened. Black nickel. Qty 24.

A Barbed **B** Barbless

Sizes: 10, 12, 14, 16

Code 20A0132 £7.49



FW524/525 - Superdry
A perfect hook for emergers and parachute flies. Chemically sharpened. Black nickel. Qty 24.

C Barbed **D** Barbless

Sizes: 10, 12, 14, 16

Code 20A0133 £7.49



FW540/541 - Curved Nymph
This curved design makes all nymphs look good. Chemically sharpened. Black nickel. Qty 24.

E Barbed **F** Barbless

Sizes: 8, 10, 12, 14

Code 20A0134 £7.49



FW580/581 - Wet Fly
Strong wet fly hook for wet flies and larger nymphs. Chemically sharpened. Black nickel. Qty 24.

G Barbed **H** Barbless

Sizes: 8, 10, 12, 14

Code 20A0135 £7.49



FW550/551 - Mini Jig
A superb hook for tying modern style jig nymphs. Chemically sharpened. Black nickel. Qty 24.

I Barbed **J** Barbless

Sizes: 8, 10, 12, 14

Code 20A0136 £7.49



FW510/511 - Curved Dry Fly
The curved design adds to the realism of a dry fly. Chemically sharpened. Black nickel. Qty 24.

K Barbed **L** Barbless

Sizes: 10, 12, 14, 16

Code 20A0137 £7.49



FW520/521 - Emerger
Classic looking emerger hook. Chemically sharpened. Black nickel. Qty 24.

M Barbed **N** Barbless

Sizes: 10, 12, 14, 16

Code 20A0138 £7.49



FW530/531 - Sedge Dry
Slightly curved and longer hook for caddis & sedges. Chemically sharpened. Black nickel. Qty 24.

O Barbed **P** Barbless

Sizes: 10, 12, 14, 16

Code 20A0139 £7.49

FULLING MILL TROUT HOOKS

FM5005 Heavyweight Champ Barbless
Heavy gauge wire, sproat bend, 3x strong, claw point. Black nickel. Qty 50.
Sizes: 10, 12
Code 35005 £8.75



FM5065 Czech Nymph Barbless
Standard gauge wire, curved bend, standard shank, forged, claw point. Black nickel. Qty 50.
Sizes: 10, 12, 14, 16
Code 35065 £8.75



FM5025 Grab Gape Barbless
3X short shank with wide gape, sproat bend, wide gape, claw point. Black nickel. Qty 50.
Sizes: 8, 10, 12, 14, 16
Code 35025 £8.75



FM5045 Jig Force Barbless
Extra wide bend, 50° eye, 2x heavy, claw point. Black nickel. Qty 50.
Sizes: 12, 14, 16
Code 35045 £8.75



FM1160 Super Grub
Continuous bend, down eye, forged, reversed. Bronze. Qty 50.
Sizes: 10, 12, 14
Code 31160 £7.75



FM1180 All Purpose Light
Round bend, down eye, 3x fine wire. Bronze. Qty 50.
Sizes: 8, 10, 12, 14
Code 31180 £7.75



FM1550 All Purpose Medium
Sproat, down eye, standard wire. Bronze. Qty 50.
Sizes: 8, 10, 12, 14
Code 31550 £7.75



FM1530 Competition Heavy Weight
Sproat, down eye, 3x strong, 1x short. Bronze. Qty 50.
Sizes: 6, 8, 10, 12, 14
Code 31530 £7.75



FM1165 Super Heavy Grub
Continuous bend, down eye, 2x heavy, standard shank, forged, reversed. Bronze. Qty 50.
Sizes: 8, 10, 12, 14
Code 31165 £7.75



FM1510 Short Shank Special
Wide gape, sproat, down eye, 3x short. Bronze. Qty 50.
Sizes: 6, 8, 10, 12, 14, 16
Code 31510 £7.75



FM1710 Nymph Special
Round bend, forged, down eye, 4x long. Bronze. Qty 50.
Sizes: 8, 10, 12, 14, 16
Code 31710 £7.75



FM2220 Traditional Streamer
Round bend, forged, down eye, 4x long. Bronze. Qty 50.
Sizes: 8, 10
Code 32220 £7.75



FM5050 Ultimate Dry Barbless
Down eyed dry fly, standard gauge wire. Black nickel. Qty 50.
Sizes: 12, 14, 16
Code FM5050 £8.75



FM5095 Comp Heavyweight Barbless
Sproat down eye, 3x strong, 1x short. Black Nickel. Qty 50.
Sizes: 8, 10, 12
Code FM5095 £8.75



FM5120 Grub Boss Barbless
Straight eyed super strong 2x heavy, 2x short. Black Nickel. Qty 50.
Sizes: 8, 10, 12, 14
Code FM5120 £8.75



FM1531 Competition Heavyweight
Sproat down eye, 3x strong, 1x short. Black Nickel. Qty 50.
Sizes: 10, 12
Code FM1531 £7.75

FARIO HOOKS



Fario 301 Wet Fly Barbless Bronze

A superb sharp barbless wet fly hook ideal for UK stillwater flies. Bronze. Qty 100.

Sizes: 10, 12, 14

Code 23A0096 £12.99



Fario 301 Wet Fly Barbless Black

A superb sharp barbless wet fly hook ideal for UK stillwater flies. Black. Qty 100

Sizes: 10, 12, 14

Code 23A0096 £12.99



Fario 302 Short Shank Barbless Bronze

The ultimate hook for tying FABs, Blobs and other bulky bodied flies. Bronze. Qty 100

Sizes: 8, 10, 12

Code 23A0097 £12.99



Fario 302 Short Shank Barbless Black

The ultimate hook for tying FABs, Blobs and other bulky bodied flies. Black. Qty 100

Sizes: 8, 10, 12

Code 23A0097 £12.99

OSPREY TROUT HOOKS



VH131 Nymph

Down eye, 1X strong wire, 2X long shank, round bend. Light bronze. Qty 25.

Sizes: 10, 12

Code 12A0104 £2.59



VH152 Standard Grub

Down eye, Fine wire, 1X short shank, reversed bend. Light bronze. Qty 25.

Sizes: 10, 12, 14

Code 12A0107 £2.79



VH111 Dry Fly/Light Nymph

Down eye, Standard wire, 1x long shank, round bend. Light bronze. Qty 25.

Sizes: 10, 12, 14, 16

Code 12A0110 £2.59



VH115 Curved Nymph

Straight eye, standard wire, 3X long shank, forged bend. Light bronze. Qty 25.

Sizes: 10, 12, 14

Code 12A0111 £2.59



VH141 Long Shank Streamer

Down eye, 1x strong wire, 4x long shank, round bend. Light bronze. Qty 25

Sizes: 8, 10, 12

Code 12A0105 £2.79



VH121 Heavyweight Wet Fly

Down eye, 2X strong wire, 1X short shank, sroat bend. Light bronze. Qty 25.

Sizes: 8, 10, 12

Code 12A0108 £2.59



VH120 Wet Fly Standard

Down eye, 1X fine wire, standard shank, sroat bend. Light bronze. Qty 25

Sizes: 8, 10, 12, 14

Code 12A0106 £2.59



VH151 Heavyweight Grub

Down eye, 1X strong wire, 1X short shank, reversed bend. Light bronze. Qty 25.

Sizes: 8, 10, 12, 14

Code 12A0109 £2.79

SINGLE SALMON HOOKS



Salmon Fly Brooch Pin

A great way of showing off your fly tying skills. Qty 1.

Sizes: 1/0

Code 19A0144 £2.29



Terry Griffiths Salmon

The ideal shape for tying fully dressed salmon flies. Qty 10.

Sizes: 1/0

Code 19A0145 £6.99



Partridge M2 Single Salmon

Heavyweight, looped eye. Black. Qty 10

Sizes: 2, 4, 6, 8, 10

Code 13149 £9.49



Kamasan B-180

Tapered loop turned up eye. Black. Qty 25.

Sizes: 4, 6, 8, 10, 12

Code B180 £4.99



Osprey VH001 Scandinavian Single Salmon

A straight eye, york bend, 3 x long, forged hook. Qty 10.

Sizes: 4, 6, 8, 10, 12

Code 19A0142 £4.79



Patriot Stinger - ST

Wide gape & super sharp points make this a perfect hook for tube flies. Forged bends, short shanks, slight up eye. Black nickel. Qty 10.

Sizes: 1/0, 2, 4, 6, 8, 10, 12, 14 £3.99

2/0 £4.99 3/0 £6.99

Code 14A0216



Partridge N2 Low Water

Medium-weight, looped eye. Black. Qty 10

Sizes: 2, 4, 6, 8, 10

Code 13151 £7.49



Patriot Intruder - Z4

Super sharp beaked point, extra strong forged offset bend with an up eye. Black nickel. Qty 10

Sizes: 2/0, 1/0, 2, 4, 6, 8, 10

Code 14A0217 £3.99

DOUBLE SALMON HOOKS



Patriot Double Up Eye - CS16/2

Bend & straight needle points, as well as forged bends for added strength. Up eye. Qty 10.

Sizes: Black 6, 8, 10, 12, 14

Silver 6, 8, 10, 12, 14

Gold 6, 8, 10, 12, 14

Code 14A0218 £8.99



Ahrex Hooks Salmon Progressive Double HR420

A beautiful looking long shank double with a slight curve and a micro barb. Black nickel. Qty 5.

Sizes: 6, 8, 10

Code 20B0063 £7.49



Partridge P Double Salmon

Heavyweight, up eye. Black. Qty 10

Sizes: 4, 6, 8, 10

Code 13158 £8.99



Osprey Scandinavian Salmon Doubles VH003

An extra strong salmon double with a 1x long shank U/E and Black nickel finish. Qty 10.

Sizes: 6, 8, 10, 12, 14

Code 15A0069 £7.59



Fulling Mill Magni Doubles

Extra strong premium salmon double hook. Qty 12.

Colours: Black £10.75 Silver £10.75

Gold £10.25

Sizes: 6, 8, 10, 12, 14

Code 15A0091



Partridge Q2 Double Low Water Salmon

Medium-weight, up eye. Black. Qty 10

Sizes: 6, 8, 10, 12

Code 13160 £8.99



Guideline Double Salmon

Very sharp & well made quality hooks suitable for huge Scandinavian salmon. Qty 10.

Sizes: 6, 8, 10, 12

Code 10056 £14.99



Kamasan B-280 Salmon

Double low water turned up eye, forged. Black. Qty 10.

Sizes: 8, 10, 12

Code B280 £6.99

TREBLE SALMON HOOKS

Partridge X2B Longshank

Salmon fly trebles, standard wire, long shank, outpoint, up eye. Black. Qty 10

Sizes: 6, 8, 10, 12, 14
Code 13168 £7.99

Kamasan B-380

Up eye, long shank. Black. Qty 10

Sizes: 10, 12, 14
Code B380 £7.99

Veniard's Waddington

Treble Specially designed to complement Waddington shanks. Round bend, ring eye, strong wire. Can be used with tubes. Black. Qty 25. **Sizes:** 8, 10, 12

Code 70155 £10.99

Esmond Drury Trebles

Outpoint wide gape treble. Qty 10.

Sizes: Black 6, 8, 10, 12, 14 **£7.59**
Silver 10, 12, 14 **£7.59**

Gold 10, 12, 14 **£8.59**
Code 13189

Fulling Mill Micro Trebles

Wide gape, short shank trebles. Silver nickel. Qty 12.

Sizes: 14, 16, 18
Code 18A0140 £10.75

TUBE HOOKS - TREBLE, DOUBLE AND SINGLE

Guideline Tube Double

Very sharp & well made quality hooks suitable for huge Scandinavian salmon. Qty 10.

Sizes: 4, 6, 8
Code 10055 £14.99

Fulling Mill FM7171 Tube Fly Double

Extra strong wire, short & straight eye, these are the perfect hook to use with your tube flies. Black nickel. Qty 12.

Sizes: 4, 6, 8, 10, 12
Code 37171 £10.75

Patriot Nordic Tube Double - NTD

Wide gaped with sharp points & a unique barb system. Forged bend, short shank & fine straight eye. Black nickel. Qty 10.

Sizes: 4, 6, 8, 10, 12
Code 14A0219 £10.99

Osprey VH002 Scandinavian Tube Double

A very nice and very good tube double. Short shank, extra strong, straight eye. Black nickel. Qty 10.

Sizes: 4, 6, 8, 10, 12
Code 12A0112 £7.69

Ahrex HR440 Tube Double

A strong double hook with a straight needle eye, short shank and wide gape. Chemically sharpened. Black nickel. Qty 5.

Sizes: 4, 6, 8, 10
Code 20A0153 £7.49

Guideline Extra Strong Tube Treble

Very sharp & well made quality hooks suitable for huge Scandinavian salmon. Qty 10.

Sizes: 4, 6, 8, 10, 12
Code 10054 £15.99

Kamasan B-990 Tube Fly Treble

Round bend, oblong ring eye, extra strong wire. Bronze. Qty 10.

Sizes: 4, 6, 8, 10, 12, 14
Code B990 £6.49

Osprey VH004 Scandinavian Micro Treble

An extra-strong, short-shanked micro treble with a wide gape. Silver nickel. Qty 10.

Sizes: 14, 16
Code 18A0141 £5.59

Patriot Nordic Tube Single - NTS

Modified Sproat bend, wide gape, x-strong hook. Black nickel. Qty 10.

Sizes: 4, 6, 8, 10, 12, 14
Code 14A0220 £3.99

Ahrex HR430/431 Tube Singles

A strong single hook with a straight eye, short shank and wide gape. Chemically sharpened. Black Nickel. Qty 12.

A Barbed **B** Barbless
Sizes: 2, 4, 6, 8
Code 20A0152 £7.75

SALTWATER HOOKS

Partridge Sea Prince

A quality all-round, stainless steel, saltwater fly hook. Suitable for all predatory species from bass to bonefish. Qty 15.

Sizes: 2/0, 1/0, 1, 2
Code 23A0092 £4.49

Partridge Saltwater Shrimp

A superb stainless steel hook for saltwater shrimp imitations, bonefish, mullet and short streamer patterns. Qty 15.

Sizes: 4, 6, 8, 10
Code 23A0093 £4.49

Gamakatsu SC17 Tarpon

These are among the strongest and sharpest saltwater hooks available, designed for tarpon and other huge fish. High carbon steel with a black nickel finish. Qty 10.

Sizes: 3/0, 2/0, 1/0
Code 23A0094 £11.99

Gamakatsu SL45 Bonefish

A strong and sharp hook designed for bonefish flies and other saltwater patterns. Made from high carbon steel with a black nickel finish. Qty 12.

Sizes: 4, 6, 8, 10
Code 23A0095 £7.99

Osprey VH153 Saltwater

A straight eye, 1 x strong, stainless steel, forged hook. Qty 12.

Sizes: 2, 4, 6, 8
Code 19A0143 £2.99

PIKE

Fulling Mill FM2461 Pike Hook

Aberdeen, straight eye, 3x long shank.

Black nickel. Qty 10.
Sizes: 2/0, 4/0, 6/0
Code 32461 £7.75

WEIGHTS

Adhesive Lead Foil

Cut to shape with scissors for creative, shaped, weighted under bodies. 1 sheet per pack.

Code 27709 £2.99

Veniard's Flat Lead

Ideal for building smooth profiled under bodies on nymphs etc. **Sizes:** Ex Fine (1mm wide), Standard (2mm wide)

Code 90330 £2.49

Veniard's Tungsten Sheet

150% heavier than lead by volume. Flexible rubberised sheet that can easily be cut & shaped.

Code 90337 £8.59

WADDINGTON

Waddington Shanks

Slightly tempered for extra strength. Leading eye turned up. Qty 20. Silver.

Sizes: 15mm, 20mm, 25mm
Code 14A0105 £4.49

BEADS

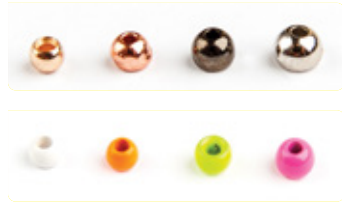

Fulling Mill Brass Beads

High quality brass beads. Used by expert fly tyer Davie MacPhail these beads are a 'must have' in your fly tying kit. Qty 50.
Sizes: 2.0mm, 2.4mm, 2.8mm, 3.2mm, 3.8mm
Colours: Gold, Silver, Copper, Black, Fl Orange, Fl Chartreuse, Fl Pink
Code 18A0501 £4.99

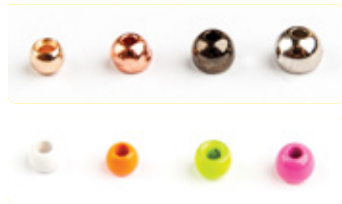

Fulling Mill Tungsten Beads

Premium tungsten beads. Ideal weighting for flies and added attraction. Qty 25
Sizes: 2.0mm, 2.4mm, 2.8mm, 3.2mm, 3.8mm
Colours: Gold, Silver, Copper, Black, Fl Orange, Fl Chartreuse, Fl Pink
Code 18A0502 £6.49



Fulling Mill Slotted Tungsten Beads

High quality slotted tungsten beads, perfect to use when tying nymphs, jigs and streamer patterns. Qty 25.
Sizes: 2.0mm, 2.4mm, 2.8mm, 3.2mm, 3.8mm
Colours: Gold, Silver, Copper, Black
Code 18A0503 £6.49



Rainbow Beads

A great alternative to the standard silver & gold beads Qty 30. **Sizes:** 3mm, 4mm
Code 10270 £1.99



Veniard's Bead Chain

Bead chain with an anti-tarnishing coating. **Sizes:** Small 2mm, Medium 3mm, Large 4mm **Colours:** Silver, Gold
Code 12A0098 £2.09



Veniard's Empty Bead Box with Tweezers

An 18-compartment bead (or hook) box with 2-pairs of bead tweezers, one for smaller beads and one for larger. Great for sliding beads onto hooks.

Size: 19 x 9 x 2cm
Code 22A0077 £18.99



Veniard's Beads

Precision made solid beads. Drilled with a tapered hole. Non-tarnish finish. Qty 25 **Sizes:** XSmall, Small, Medium, Large. **Colours:** Gold, Silver, Copper
Code 27681 £2.49



Bead Dispenser

20 beads, 4 of each sizes in a handy easy to use dispenser.
Colours: Gold, Silver, Copper
Code 90338 £8.29 pack



Veniard's Brass Beads

Extra bright enamel plate brass beads with tapered hole. Qty 25 **Sizes:** XSmall 2.8mm, Small 3.3mm, Medium 4.0mm
Colours: Fl Orange, Fl Yellow, Fl Pink
Code 12A0099 £3.39



Tungsten Countersunk Beads

Great coloured super heavy tungsten beads. Qty 25.
Size: 2.8mm, 3.2mm, 4.0mm
Colours: Gold, Silver, Black Nickel, Fl Orange, Fl Yellow, Met Red, Met Pink, Rainbow.
Code 15A0094 £5.99



Firefly Hot Head Beads

Lightweight plastic beads, countersunk for easy use. **Sizes:** 3mm, 4mm.
Colours: Fl Orange, Fl Green, Fl Red.
Code 13439 £2.99

TUBING



Slipstream Tubes

A range of tubes for all sizes of tube flies. The aluminium & copper are plastic lined to protect leader material. Qty 10.

Options: Plastic, Aluminium, Copper
Code 13191

Length	Plastic	Aluminium	Copper
0.50"	£1.79	£1.99	£2.59
0.75"	£1.89	£2.09	£2.89
1.00"	£1.99	£2.19	£3.09
1.25"	£1.99	£2.29	£3.29
1.50"	£2.09	£2.39	£3.49
1.75"	£2.19	£2.49	£3.69
2.00"	£2.29	£2.59	£3.79



Silicone Rubber Tubing

Extra soft & pliable, this is the most popular tubing for use with tube flies & Waddingtons. 35cm per pack.

Colours: Clear, Black, Dayglo Orange, Dayglo Green, Dayglo Yellow.

Code 70156 £1.49

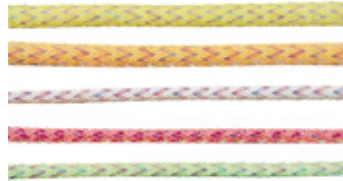

Colour Glow Pearl Mylar Piping

Strands of iridescent pearl and luminous colour glow material are interwoven to give an outstanding body material. 1m.

Sizes: Small, Medium
Colours: Lime, Orange, Red, White, Yellow
Code 14A0408 £3.19



Mylar Tubing

This is Mylar woven into a tube.

Colours: Silver, Gold, Pearl
Sizes: Fine, Medium
Code 13406 £2.39



FireFly Lumi Beads

Similar to the Hot Heads but in luminous greenish white colour. Ideal for sea-trout. Charge with a torch before using. 4mm only
Code 13440 £2.99



Veniard's Bottle Tubes

Precision machined tubes available in brass or aluminium extensions in each material available to make the tube to any length & allows the weight to be distributed from front to back as required. Qty 10

Sizes: 15mm £2.99 22mm £3.79
Options: Brass, Aluminium
Code 15A0035



Franc N Snaelda 1.8mm & 1.4mm Inner Liner Tubing

1.8mm inner lining tubing designed to work with FNS tubes and outer tubing. 20cm long. Qty 10.

Colours: Fl. Yellow, Fl. Red, Fl. Orange, Black, Clear (1.4mm - Clear only).

Code 19A0107 £4.59



Franc N Snaelda Outer Tubing

3.0mm outer tubing, perfect with FNS tubes and tube lining. 20cm long. Qty 10.

Colours: Fl. Yellow, Fl. Red, Fl. Orange, Black, Clear.

Code 19A0108 £4.69



Franc N Snaelda Soft PVC Tubing

Perfect fit for FNS tubes and other bottle tubes. 100cm long.

Colours: Black, Clear, Red, Orange.
Code 19A0110 £3.99



Veniard's Tube Liner 1.53mm

Polythene tubing for lining bottle tubes, also the same material used to line Slipstream Tubes. 50cm per pack.

Code 70157 £1.59



Lazer Holographic Mylar Tubing

Super holographic scale effect which is ideal for fry patterns. 1m per pack.

Sizes: Small, Medium
Code 23989 £3.59

TUBING



Franc N Snaelda HW Signature Tubes

A heavier, thicker tube of equivalent weight to tungsten. Designed for high or fast water.

Options: Unflanged or Flanged. Qty 10.
Sizes: 10mm, 14mm, 19mm
Code 19A0112 £6.99



Unflanged Flanged

Franc N Snaelda Signature Tubes

These tubes are perfect for tying snaelda/francis style flies or standard weighted tube flies.

Options: Unflanged or Flanged. Qty 10.
Sizes: 10mm, 14mm, 19mm
Code 19A0111 £6.99



Franc N Snaelda Tungsten Signature Tubes

A tungsten version for when you need to get deep in high or fast water.

Options: Unflanged or Flanged. Qty 10.
Sizes: 10mm, 14mm
Code 19A0099 £14.39



Franc N Snaelda T-Tubes

A brass tube with a flanged head to make tying easier. Lighter than signature tubes but still heavy enough. Qty 10.

Sizes: 15mm, 20mm, 25mm
Code 19A0092 £6.99

CONES



Franc N Snaelda Signature Coneheads

Great shape and colours. Works well with FNS 1.8mm inner tube. Qty 10.

Sizes: 4.5mm, 5.5mm, 6.5mm
Colours: Gold, Silver, Orange, Black, Dark Red.

Code 19A0113 £6.99

EYES



Veniard's Booby Eyes

Cylinder shapes of Ethafoam which can be tied on to a hook.

Sizes: 5mm, 7mm, 9mm.
Colours: Black, Orange, White, Yellow
Code 13414 £2.69

Veniard's Booby Eye Sets

Cut from the finest quality Plastazote, 10 of each of 11 colours.

Sizes: 5mm, 7mm or 9mm
Colours: Black, Blue, Chartreuse, Green, Lime Green, Orange, Pink, Purple, Red, White, Yellow.

Code 17A0507 £6.99



Veniard's Epoxy Eyes

Self adhesive & very life-like. Qty 20

Sizes: Small 3mm, Medium 5mm.
Colours: Silver/Black, Red/Black.

Code 13413 £2.99



Veniard's Floozeyes

Buoyant dumbbell eyes, simple to tie on. Perfectly balanced eyes every time. Ideal for skipping buoyant lure along the lake bed.

Size: 6mm
Colours: Fl Orange, White, Black, Fl yellow.

Code 134414 £3.39



Micro Glow Eyes

Perfect for the smallest of saltwater shrimp & crab patterns. 25mm long. Qty 6 Pairs

Colour: Phosphorescent White with a Fibre Optic shaft.

Code 14A0409 £2.99



Glow Eyes

The easy way to ensure that you get the best imitation shrimp & crab eyes. 25mm long. Qty 6 Pairs. **Colour:** Phosphorescent White with a pink stem

Code 14A0410 £2.99



Wapsi Dolls Eyes

Coloured plastic eyes with moveable pupils that rattle. Qty 36

Sizes: 4mm, 7mm.
Colours: Yellow/Black, White/Black, Fire Orange/Black.

Code 27678 £2.69



Veniards Pre-Formed Booby Eyes

Perfect booby eyes that have been trimmed, shaped and whipped ready for you to tie straight on. 10pk.

Sizes: Small 5mm or Medium 7mm
Colours: Black, Chartreuse, Orange, Pink, White, Yellow

Code 20A0156 £2.99



Veniard's Damsel Bead Eyes

A pair of beads on a short nylon stalk.

Ideal for damsel eyes. Qty 15
Size: Small
Colours: Olive, Black, Red

Code 13417 £1.99



Veniard's Easy Shrimp Eyes

Easy shrimp eyes are formed in a Y shape so you get perfect placement every time. The stem of the Y is flattened with grooves making tying in is easy and firm. Medium.

Code 15A0093 £8.29



Veniard's Easy Shrimp Legs

Incorporates one of the most innovative tying solutions. Simply hold in position, tie in securely and cut off the tab.

Sizes: Medium (6pk)
Colours: Clear or Orange
Code 22A0088 £8.39



Wapsi Dumbbell Eyes - Lead

Weighted plain lead eyes for nymphs, lures & saltwater patterns. Range of sizes to fit hooks from 12's up to 1's. Qty 10

Sizes: Mini, XSmall, Small, Medium
Code 27679 £2.19



Painted Dumbbell Eyes - Lead

Painted version of the above. Qty 10.

Sizes: Small, Medium
Colours: Yellow/Black, Red/Black, Pearl/Black
Code 27680 £3.59

INTRUDER HACKLE



Franc N Snaelda Intruder Hackles

Handpicked, cleaned and dyed. These are the best Rhea feather substitutes available. Perfect for Intruder style flies.

Colours: Black, Yellow, Hot Orange, Red
Code 19A0095

Small **£5.49 (pk10)**

Large **£7.99 (pk3)**

PREDATOR FIBRES



Semperfli Predator Fibres

A synthetic material that sheds water, moves beautifully and casts easily. Perfect for saltwater and baitfish patterns but can also be used for dubbing and wings. 50cm lengths.

Colours: White, Black, Silver Baitfish, Tan, Chartreuse, Olive
Code 23A0111 £6.99

MOP BODIES



Veniard's 6mm Mop Chenille

A thick and dense 6mm mop chenille. A proven fish catching material, ideal for tying mop and wotsit flies. 145cm length.

6 Colours: Natural Grub, Black, Sunburst Yellow, Chartreuse, Fluorescent Orange, Speckled Earthworm
Code 21A0089 £2.29

NYMPH BODIES

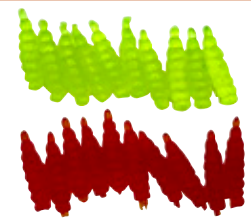

Jelly Nymph Bodies

Realistic, non-toxic & biodegradable. These grub bodies are an easy answer to achieving ultra realistic nymph patterns.

Pack 10. **Colours:** Chartreuse or Red
Code 14A0407 £3.29

THREADS



Wooden Spool Safe

Attractive, stylish & handy. This is a spool storage device that you will be proud to own & will look good on your tying desk. Holds an incredible 72 spools. Rotate the cylinder to select your choice.

Code 80337 £64.99



UTC Thread 140D

Extra strong, lightly waxed nylon thread. A silky smooth thread that lies very flat. 140 denier.

Colours: White, Black, Red, Yellow, Dark Brown, Olive, FI Fire Orange, FI Chartreuse, FI Green

Code 90322 £2.99

UTC Thread 70D

As above but a finer thread. 70 denier.

Colours: White, Black, Red, Yellow, Dark Brown, Olive

Code 90322 £2.99



Sheer Ultrafine Thread 14/0

A single ply thread, lightly waxed with incredible strength. Flies can be securely finished with no build up at all. Ideal for midges & Clyde style flies.

Colours: Black, Primrose, Brown, Red, Claret, Dun, Cinnamon, Green, Olive

Code 90325 £1.89



Uni-Floss

Super quality single strand floss. A blend of nylon & rayon. It is very strong & shiny. **Colours:** Olive, Black, Burnt Orange, Red, Bright Yellow

Code 90326 £1.59



Glo-Brite Fluorescent Floss - 25m

The original super-bright, colourfast, fluorescent floss devised by Tom Saville over 30 years ago. **Colours:** 1-Neon Magenta, 2-Pink, 3-Crimson, 4-Scarlet, 5-Fire Orange, 6-Hot Orange, 7-Orange, 8-Amber, 9-Chrome Yellow, 10-Yellow, 11-Phosphor Yellow, 12-Lime Green, 13-Green, 14-Blue, 15-Purple, 16-White

Code 13384 £1.29 per 25m spool

£21.29 Selection of all 16 Colours



Uni-Thread Trico 17/0

Ultra fine thread for micro patterns. The extra fine polyester thread is amazingly strong for its diameter.

Colour: Semi Translucent White
Code 90321 £1.79



Semperfli Nano Silk

An amazing thread, extremely strong and fine, it gives confidence to fly tyers and avoids build up. MUST be used with ceramic bobbin holders. 50m spools.

Sizes: 12/0 - 50D **£3.75**

18/0 - 30D **£3.99**

Colours: Black, White, Red, Olive, Brown, Orange

Code 20A0125



Semperfli Waxed Thread

A stronger, flatter, easy to split, pre-waxed thread which gives you more grip and prevents materials slipping. 240yds spool.

Sizes: 8/0 - 75D or 12/0 - 50D

Colours: Black, White, Red, Medium Olive, Tan, Hot Orange

Code 20A0126 £2.99

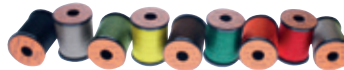

Uni-Thread 6/0

Made of continuous polyester filaments slightly bonded. The filaments are not twisted so tie virtually flat on the hook.

Colours: Black, White, Olive, Yellow, Dark Brown, Green, Orange, Red, Tan, Chartreuse, Fire Orange

Code 133910 £3.69



Uni-Thread 8/0

As above but the 8/0 is a finer pre-waxed thread. **Colours:** Black, Olive, Brown, Grey, Orange, Lt. Cahill

Code 15A0037 £3.69



Uni-Thread BigFly 3/0

Specifically designed for large saltwater, pike flies & other patterns that require a strong easily handled thread. Untwists easily for flat thread use.

Colours: Black, White, Chartreuse
Code 80069 £3.79

TINSELS



UTC Midge Tinsel

A super-fine tinsel that can be used straight from a bobbin holder to tie tinsel bodied flies and Perdigon style flies.

Colours: Black, Gold, Pearl, Silver

Code 20A0154 £2.89



Uni 2-Tone Mylar

Top quality extra strong Mylar tinsel. Different colour on each side of the tinsel.

Colours: Gold/Silver, Copper/Blue, Red/Green, Peacock/Orange

Sizes: S#16, M#14, L#12

Code 13403 £1.89

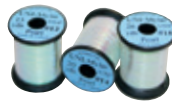

Uni Pearl Mylar

A very strong Pearl Mylar, ideal for most tying applications **Colour:** Pearl

Sizes: S#16, M#14, L#12

Code 90328 £1.89



Uni Holographic Tinsel

A very strong and good value holographic tinsel, better quality than rival brands.

Colours: Black, Chartreuse, Gold, Light Blue, Orange, Rainbow, Red or Silver

Sizes: Medium, Large or Extra Large

Code 15A0070 £1.89

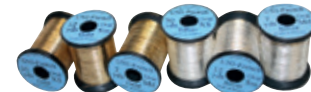

Uni French Oval Tinsel

Uni Products have developed this top quality oval tinsel. **Colours:** Gold, Silver

Sizes: XSmall, Small, Medium

Code 90327 £4.79



UTC Mirage Tinsel

Highly reflective, similar to Mirror Flash. Excellent for flashback nymphs.

Sizes: Small, Medium, Large

Code 80070 £2.99

UTC Ice Blue Pearl Tinsel

Flashback pearl tinsel with a brilliant UV blue iridescence.

Sizes: Small, Medium, Large

Code 10269 £2.79



Holographic Flat Braid

Holographic tinsel which has been braided to form this sparkling body material.

Colours: Silver, Gold, Red

Code 80073 £3.79

WIRES



Veniard's Lead Wire

Essential material for weighting flies.

Sizes: Small Spool - Ex Fine (0.40mm), Medium (0.60mm) **£2.19**

Sizes: Bulk Spool - Ex Fine **£6.89**

Medium **£6.19**

Code 13372



Veniard's Copper Wire

Great for either weighting flies or using for ribbing.

Sizes: Fine (0.125mm), Medium (0.40mm)

Code 90331 £1.99



Veniard's Wire

Flexible ribbing material.

Colours: Silver, Gold. **Sizes:** 25

(.19mm), 26 (.16mm), 27 (.13mm)

Code 13368 £2.59



Uni-Coloured Soft Copper Wire

These extra soft easy to work wires come in two diameters.

Colours: Black, Red, Natural Copper, Gold

Sizes: Fine (0.20mm), Medium (0.30mm)

Code 90332 £3.89

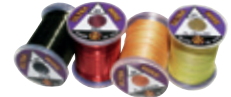

UTC Coloured Wire

Ultra wire is a non-tarnish copper wire. Perfect for ribbing, weighting, flash, wire bodies & dubbing brushes. **Size:** Brassie

Colours: Black, Red, Olive **£2.99**

Colours: Hot Orange **£4.49**

Code 27711



Veniard Copper Wire Selection

Slightly thicker than standard fine copper wire at 0.2mm. This coloured wire is great for bodies, ribs etc.

Code 23A0083 £25.89

YARN



Uni-Leech Yarn

Long fibred mohair. An excellent alternative to dubbing.

Colours: Black, Brown, Gold, Olive, Red

Code 23994 £2.59

DUBBING

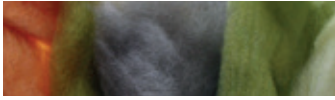

Super Fine Dubbing

The finest synthetic dubbing, perfect for dry flies & emergers to the smallest size. Treated to float. Excellent range of colours for 'matching the hatch.'

Colours: Black, Dk Tan, Tan, Lt Cahill, March Brown, Olive, Adams Grey, Pale Evening Dun, Pale Morning Dun.

Code 27674 £2.59



SLF Dubbing Box

SLF is the original synthetic living fibre, tremendously popular & widely used for its translucence & lifelike sparkle.

Code 70158 £26.39



Glister Sparkle Dubbing Box

Glister must rank as the best sparkle dubbing for ease in use. The wide range of imaginative colours which cover all areas of fly tying.

Code 13327 £20.99



Hare Dub Dubbing Box

12 colours of hare fur, a classic standard dubbing blended with SLF. Perfect for a wide range of uses from large buggy patterns to small nymphs & emergers.

Code 27719 £23.19



Antron Dubbing Box

Selection of 12 popular colours of this soft synthetic, translucent dubbing material.

Code 10217 £17.29



Natural Fur Dubbing Box

A selection of natural furs in a handy 12 partition dispenser.

Code 10216 £28.99



Semperfli Dry Fly Polyarn Multicard

A bonded, floating polyarn that functions like 'dubbing on a rope'. Ideal for dubbing bodies and shucks. 10 colours per card.

Code 21B0079 £5.49



Seals Fur Sub Box

12 colours of the most popular colours of this great natural dubbing. The closest we've seen to genuine seal's fur.

Code 16A0138 £13.49

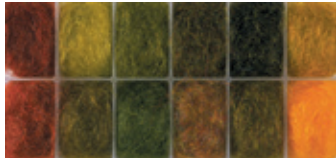

Frankie McPhillips Traditional Irish Dubbing Box

The range of all 24 colours in 2 selection boxes. These easy to dub blends come in beautiful natural colours that are suitable & will cover a wide variety of patterns.

Code 10213 £27.49 Each



Veniard's Stickle Dub

A superb dubbing made from natural guard hairs that is easy to use and gives a scruffy finish that creates the movement that fish find irresistible.

Colours: Ginger, Nat Grey, Nat Dark, Yellow, Orange, Coachman Brown, Golden Olive, Dark Orange, Olive, Dark Brown, Fiery Brown, River Shrimp.

Code 21A0091 £2.39



Veniard's Peacock Dub

A super fine dubbing which is fine enough for collars on small nymphs and also works great as a peacock substitute.

Colours: Rainbow Black, Orange, Dark Olive, Purple, Green Black, Olive
Code 21A0092 £2.19



SLF - Davy Wotton

SLF is the original synthetic living fibre, tremendously popular & widely used for its unique lifelike sparkle.

Colours: Insect Green, Medium Olive, Fiery Claret, Fiery Orange, Fiery Red, Fiery Yellow, Rust Brown, Black, Natural Seal.

Code 14A0411 £3.99



Glister Sparkle Dubbing

A highly iridescent, sparkling lifelike material that can be dubbed as easily as wool. The secret is an exclusive texturing process available only in this product. If you need a dubbing with colour, sheen & flash, this material is it.

Colours: Pearl, Golden Olive, Orange, Peacock Black, Dk Olive, Brown
Code 13334 £4.09



Seals Fur (Genuine)

Body dubbing material.

Colours: Black, Claret, Fiery Brown, Golden Olive, Highland Green, Natural, Olive, Red, Orange, Yellow.

Code 13444 £5.59

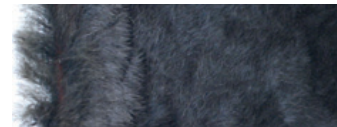

Veniard's Mole

Natural dubbing material. Whole skin.

Colour: Natural

Code 13341 £4.79



Veniard's Rabbit

Natural dubbing material

Colours: Natural English £2.69

Plain Dyed Black £3.49

Code 13364

Veniard's Hare

Create the perfect hare's ear pattern. Body fur.

Code 13363 £2.69

Hare Whole Mask

Natural £5.19

Dyed Olive £5.59

Code 13363



Semperfli Dirty Bug Yarn Dubbing

A highly fibrous dubbing material on a rope that can be used either direct as a dubbing rope or be broken apart to make dubbing.

Colours: Danica, Caddis Brown, Ivory, Mottled Caddis, Mottled Olive, Shrimp
Code 20B0075 £3.79



Patagonian Hare's Feet

Patagonian hare's feet have very long, coarse hair, perfect for parachutes, dubbing and spinning.

Colours: Black, Brown, Natural, Olive, Orange
Code 18A0506 £4.79



Semperfli Polyarn Multicard

A lighter than water, continuous and non-bonded floating polyarn ideal for dubbing, wings and parachute posts. 10 colours per card.

Code 21B0080 £5.49



Wapsi Natural Fur

Unique and obscure 100% natural fur. Great for tying nymphs and shrimp bodies.

Colours: Olive Hares Mask, Muskrat, Beaver, Light Hares Mask, Dark Hares Mask, Mink £4.99

Grey Squirrel, Fox Squirrel £5.99

Code 18A0508



SLF Bug Dub

A blend of hare and SLF to make the most realistic of bodies.

Colours: Orange, Grey, Red, Claret,

Light Olive, Black, Nat Hare

Code 18A0509 £3.79

CHENILLES



Wapsi Ultra Chenille

The densest chenille we have come across. The standard size is ideal for all the usual chenille work whilst the micro is specially suited for woven bodies, extra small Montana & Palomino style flies. **Sizes:** Micro, Standard **Colours:** Olive, Red, Black, White, Fl Yellow, Fl Chartreuse. **Code 27686 £2.39**



Micro Chenille - Easy Dub

Less dense than ultra chenille, the fibres therefore stand out & give a herl body effect. **Colours:** Black, Medium Olive, Yellow **Code 13376 £2.99**

Semperfli Suede Chenille Multi Card

An ultra-fine suede chenille perfect for bug and lure bodies. 10 colours per card **Colours:** **A** Steelhead **B** Standard **Code 21B0078 £5.49**



Cactus Chenille

Dazzling body material spun on thread core. **Sizes:** 6mm, 15mm. **Colours:** Chartreuse, Green, Olive, Fl Orange, White/Pearl, Black **Code 13332 £2.29**



'Turbo' Translucent Chenille

The chenille for blobs. **Colours:** Black, Sunburst Yellow, Fl Hot Orange, Fl Chartreuse, Fl UV Clear. **Code 27718 £2.29**



Krystal Chenille

This 10mm dazzling body material is made totally of Krystal Flash fibres. **Colours:** Black, Chartreuse, Olive, White/Pearl **Code 70161 £2.39**



Veniard's 10mm UV Egg Chenille

Perfect for tying blobs and eggs. Translucent fritz fibres with added UV flash that have a jelly-like look in water. **Colours:** Black, Chartreuse, Fl Orange, Coral, Pink, Sunburst Yellow **Code 20A0157 £3.79**



Micro Cactus Chenille

0.8mm spooled pearl cactus chenille. Great for hot spots, thoraxes & bodies on small flies. **Colours:** Pearl, Black, Olive, Fl Yellow, Fl Pink **Code 80051 £2.29**



UV Straggle Cactus Chenille

Chenille with sparse, long strands of UV fibres blended through it. Spooled for easy storage. **Sizes:** Extra Fine, Standard. **Colours:** Black, Claret, Olive, Silver, Gold **Code 80052 £2.29**



Super Stretch Floss

It looks like floss but it stretches. The stretch makes it easy to wind compact bodies under tension & it has an attractive sheen. Wind two contrasting colours together for segmented bodies. Sold in bundles of 12" lengths of a colour. **Colours:** Black, Dk Claret, Dk Olive, Med Olive, Lt Olive, Orange, Red, White, Hot Pink **Code 13354 £3.69**



Micro Ultra Lace

At approximately half the diameter of the standard Ultra Lace tubing. Its super slim profile is ideal for buzzer & nymph patterns, offering a ready made means of creating segmented bodies. **Colours:** Black, Clear, Olive, Red **Code 13347 £3.29**



Magic Glass/ 'V' Rib

Extra soft plastic material which is half round in cross section producing realistic flat or segmented translucent bodies. 1.4m per pack. **Colours:** Clear, Black, Red, Med Olive, Shrimp Pink **Code 90320 £2.89**

Semperfli Straggle String - Multi Card

10 assorted colours of the world's finest micro chenille on this handy multi-card. With just 2 cores **C** **D** it is perfect for thoraxes and micro legging. Great replacement for peacock herl. **Colours:** **C** Natural **D** Standard **Code 20A0127 £5.49**



FRITZ



F.A.P Plush Fritz

Dyed & used by Craig Barr himself, this Fritz offers the hottest colours available. This material will tie you that perfect shape blob. **Size:** 15mm **Colours:** Hot Orange, Sunburst Yellow, Fl. Pink, Hot Coral, Black **Code 90301 £2.89**

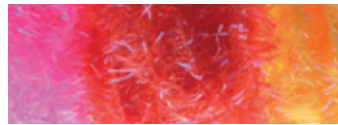

F.A.P UV Fluoro Fritz

Like the Plush Fluoro Fritz, but with added fizz of UV. When wet it offers a fly that fish just can't resist. **Colours:** Pink, Sunburst, Fl Orange **Code 90302 £2.89**

TAILING



Tail Fibres (Fibbets)

The fibres are very strong, perfectly straight & finely tapered. Perfect for dry fly tails, spent wings & antennae. **Colours:** Golden Olive, Olive, Olive Brown, Fiery Brown, Tan, Black **Code 23995 £3.69**

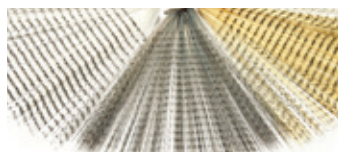

Barred Tail Fibbets

These evenly barred tail fibres will make an excellent addition to any tailed patterns. **Colours:** Pale Yellow, Silver Dun, White **Code 15A0077 £3.69**

RUBBER QUILLS



Veniard's Synthetic Quills

Very tough synthetic quills cut in 2 thicknesses. Very easy to use. **Colours:** Olive, Red, Cream, Yellow, Golden Olive **Code 15A0078 £3.69**



Veniard's Ultra 3D Uni Legs

Made from tough elastic foam these legs add a lifelike profile to all manner of dry flies. 6 per packet. **Colours:** Black or Tan **Sizes:** XSmall, Small **Code 17A0504 £4.79**

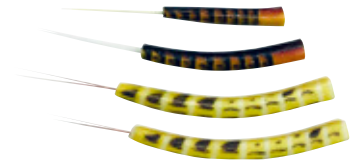

Veniard's Ultra Mayfly Bodies

These ultra-realistic foam bodies match a range of up-winged fly species. **Two options available:** Red Brown or Ephemera Danica (Mayfly) **Sizes:** Small or Medium - Red Brown Large or XLarge - Ephemera Danica (Mayfly) **Code 17A0505 £4.79**

BODY MATERIAL



Plastazote Block

A fine textured buoyant block. 6x3x1". **Colours:** White, Yellow, Orange, Black **Code 13345 £2.99**



Foam Sheet

2mm thick dense foam sheet perforated every 3mm for ease of use. Great for all types of floating patterns it will readily accept marker pens. **Colours:** White, Yellow, Black, Brown, Orange **Code 25376 £1.79**



Veniard's Foam Cylinders

High-density foam cylinders that are ideal for detached bodies on all high-floating patterns. **Sizes:** Small (2.3mm), Medium (3.2mm) or Large (4.7mm) **Colours:** Tan, Black, Orange, Olive, Yellow **Code 22A0089 £3.39 Pk 10**

SYNTHETIC & FLASHY WINGING MATERIAL

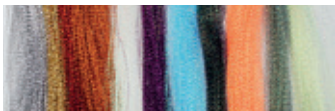

Veniard's Krystal Flash

Its corrugated fibres reflect light like no other material. Original & still the best.
Solid Colours: Silver, Gold, Red, Copper, Pearlescent Pearl, Purple, Pearl Blue, Black, Hot Orange, Olive **£4.39**
UV Colours: Tan, Pink, Herring Black, Blue, Pearl, Orange **£5.19**
Code 15A0033



Standard Mirror Flash

The original mirror flash, very bright and very flashy, as used on the blob and many other lures.
Colours: Pearl, Peacock, Orange.
Code 16A0141 £4.99



UV Enhancer

UV fibres in subtle tones these fibres will add a new dimension to wings and tails on any fly. Just a few strands will transform any pattern and give a UV reflection that fish love.
Colours: Pearl, Orange, Tan.
Code 16A0142 £5.69

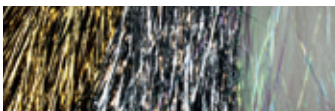

Wapsi Flashabou

Tinsel 'marabou' for added flash in lure wings, tails & saltwater bait patterns.
Colours: Gold, Silver, Pearl
Code 27702 £5.99

WORMS



Veniard's Rubber Worms

The material for worm flies. 20 x 145mm lengths.
Colours: Bloody Red, San Juan Red, Hot Pink, Earth Worm
Code 15A0072 £3.19



Veniard's 3mm Stretch Worm Chenille

Great for worm type flies. Interwoven antron and rubber fibres with a stretchy core.
Colours: Black, Blood Red, Chartreuse, Fl Orange, Pink, Sunburst Yellow
Code 20A0158 £3.49



Veniard's Grizzly Hair

Barred synthetic material, its long (40cm) length means it's great for a wide range of flies from large predator patterns to small dry flies.
Colours: Blue, Chartreuse, Orange, White, Red, Yellow.
Code 17A0506 £6.69



Krinkle Mirror Flash

A version of the mirror flash which has a crinkle effect that exaggerates the reflective qualities of this vibrant material.
Colours: Pearl, Orange, Blue, Red, Peacock Black
Code 70169 £5.59



Crystal Mirror Flash

The popular mirror flash with a twist to it, this super reflective material really has to be seen to be believed.
Colours: Pearl, Orange, Blue, Peacock Black
Code 70168 £5.59



Veniard's Micro Flash

A finer version of Krystal Flash. Ideal for that added sparkle in wings & tails of dries, ascending nymphs & emergers.
Colours: Pearl, Chartreuse
Code 27716 £4.99



Boosted Krinkle Mirror Flash

Ultra violet and holographic fibres have been blended with Krinkle Mirror Flash and dyed in new age colours to produce another superb winging or tail material.
Colours: Cherry Pearl, Midnight Fire, Goldstone, Orange Crush, Winter Run Blue, Yellow Yummy.
Code 14A0415 £5.99



Veniard's Pearl Film

Strong but light sheet pearl film perfect for flashback nymphs etc.
Options: Plain, Embossed
Code 13337 £2.69

BACK MATERIALS

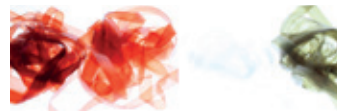

Veniard's Body Stretch

For bodies or shellbacks. 0.25" wide stretchy & translucent can be cut easily for realistic nymphs, damsels etc.
Colours: Brown, Cinnamon, Clear, Olive
Code 13342 £3.49



Wapsi Thin Skin

A thin, translucent sheet for backs & wing cases or for winding in thin strips to form nymph bodies. Malt one side & shiny the other. **Colours:** Mottled - Natural Bustard, Olive Bustard. Plain - Clear, Olive, Lt Olive.
Code 27677 £3.69

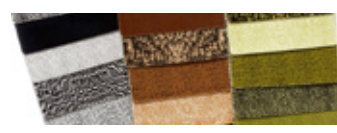

Thin Skin Mixed Selections

This selection contains 8 pieces of Thin Skin, in the following variations - Transparent, Mottled Bustard, Mottled Oak & Fly Specks.
Options: Brown, Grey, Olive
Code 18A0513 £14.99

WOOL & YARN



Antron Body Wool

Ideal for Klinkhammer posts & the perfect body dubbing material
Colours: Black, Fl Lime, Fl Orange, Fl Red, White, Fl Yellow, Medium Olive
Code 13349 £1.39



Polypropylene Floating Yarn

Untwisted yarn, popular for wings, tails etc. **Colours:** Brown, White, Yellow
Code 13353 £1.39



Chadwicks 477 Killer Bug Wool

Blended to replicate Sawyer's original as close as possible.
Code 13351 £1.99

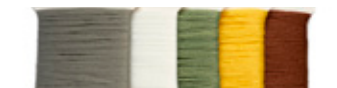

Para - Post & Wing Yarn

Super buoyant yarn. Great for posts and wings on dry flies.
Colours: Black, Olive, Orange, Red, White, Yellow
Code 18A0512 £2.39

RUBBER LEGS



Round Rubber Legs

For that added movement & vibration. Popular in fresh & saltwater flies like girdle bugs & crabs. **Size:** Medium.
Colours: Black, White
Code 27689 £3.79

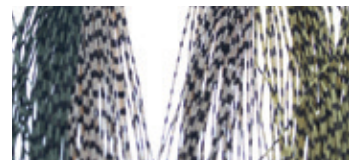

Centipede Legs

Perfect for micro rubber leg patterns. 0.4mm **Colours:** Olive, White, Yellow
Code 10271 £4.29



Wapsi Silli Legs

Rubber legs with extra barring or speckle
Barred Colours: Orange/Black, Olive/Black
Speckled Colours: Red/Black, Olive/Black, Orange/Black.
Code 27690 £3.99



Hot Tip Silli Legs

Great two tone Silli Legs. Use on crab patterns, saltwater flies or even try on streamer patterns. Adds great movement to any fly. **Colours:** Black/Red Tip, Clear Fire/Orange, Pumpkin/Orange, Chartreuse/Fire Orange.
Code 14A0403 £3.99

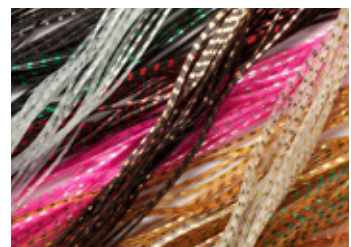

Silli Legs Chrome

These chrome barred Silli legs have the same outstanding movement/flex of regular Silli legs but now with extra pizzazz. Very attractive and really fishy.
Colours: Silver/Black, Green/Black, Red/Black, Gold/Black, Gold/Clear, Silver/Clear, Copper/Pumpkin, Gold/Pumpkin
Code 18A0511 £4.99

NECK CAPES & SADDLES

Hebert Miner™ Neck Capes & Saddles - Pro Grade

This line of Hebert Miner™ Pro Grade capes and saddles offers an exceptional quality range of natural duns, browns, creams and badger colours which are perfect for tying both modern dry flies and traditional patterns. The cape feathers are suitable for fly sizes from 8 all the way down to 20, and the saddle feathers are suited for size 10 to 14. For fly tyers who demand the very highest quality for natural looking flies, Hebert Miner™ will not disappoint.

Code 21A0087



Colour	Neck Cape - Pro Grade	Saddle - Pro Grade
Black	£89.69	£89.69
Coachman Brown	£89.69	£89.69
Cream	£89.69	£89.69
Furnace	£89.69	£89.69
Golden Badger	£89.69	£89.69
Grizzly Variant	£89.69	£89.69
Medium Brown Dun	£89.69	£89.69
Medium Ginger	£89.69	£89.69
Medium Grey Dun	£89.69	£89.69

Metz Cock Necks & Saddles

Metz produces premium genetic hackles for all your fly tying needs. They offer the highest quality & value for money. Metz Necks & Saddles are selected for their great range of colours & perfect hackles. Sized down to the smallest dry fly. The fly tyer's choice.

Available in:

- Metz Cock Neck Grade 3
- Metz Cock 1/2 Neck Grade 3
- Metz Cock Saddle Grade 2

Code 12A0020



Colours	Neck Grade 3	1/2 Neck Grade 3	Saddle Grade 2
Badger	£62.99	£31.99	£69.99
Black	£62.99	£31.99	£69.99
Brown	£62.99	£31.99	£69.99
Cream	£62.99	£31.99	£69.99
Cree	£62.99	£31.99	£69.99
Ginger	£62.99	£31.99	£69.99
Grizzly	£62.99	£31.99	£69.99
Light Blue Dun	£62.99	£31.99	£69.99
Medium Grey Dun	£62.99	£31.99	£69.99

*Subject to availability

Metz Hen Necks - Grade 1

Top quality Metz Hen Necks with soft hackles, thin quills & consistent colour. Perfect for tying soft hackled wets, North Country spiders, small woolly buggers & many other patterns. Typical Metz quality.

Colours: Black, Cream, Dun/Blue Dun, Furnace, Ginger/Brown, Grizzly

Code 12A0142 £31.99

Premium Cock Capes

These neck capes from the USA are absolute gems in their own right, & represent excellent value for money.

Colours: Black, Med Olive, Grizzly, Coachman Brown

Code 70166 £59.39

Chinese Cock Capes

Suitable for a wide range of uses. For dry flies, nymphs, wet flies, palmers, salmon & sea-trout flies.

Colours: White, Red, Black, Claret, Highlander Green, Medium Olive, Teal Blue, Hot Orange, Fl Yellow

Code 13194 £14.99



Veniard's Dyed Genetic Saddles - Grade 2

Superb quality and great value, grade-2, genetic saddles with a variety of hackle sizes ideal for a wide range of trout and salmon flies. Perfectly dyed in a choice of black or vibrant colours.

5 Colours: Black, Chartreuse, Hot Orange, Red, Yellow

Code 21A0090 £46.39



Genetic Cock & Hen Capes

Genetic saddles from the USA with hackles across the size range.

Options: Saddle Grade 1 **£56.99**

Saddle Grade 2 **£44.99** Hen **£26.99**

Colours: Grizzly, White

Code 18A0515



Whiting Saddle Capes

These larger than life saddles are superb for lures & salmon flies.

Colours: Red, Orange, Doctor Blue, Yellow, Black, White

Code 80056 £32.29



Indian Cock Capes

'A' Grade Indian cock capes in all the popular colours.

Colours: Red Game, Cree Variant, Ginger, Furnace, Badger, White

Code 15A0074 £11.39



Whiting Hen Capes - 4B

Perfect for wet flies. Superb genetic hen necks from Whiting Farms that are soft and easy to use.

Colours: Black, Brown, Greenwell, Grizzly

Code 22A0090 £32.99

HACKLES



Short Cock Hackles

Specific cock hackles, ideal for fly sizes 12 to 16

Colours: Black, Blue, Blue Dun, Brown, Claret, Med Olive, Orange, Red, Yellow, White, Assorted, Fl Assorted

Code 13200 £2.89



Natural Cock Hackles

Specific cock hackles, ideal for fly sizes 12 to 16

Colours: Ginger, Red Game

Code 13198 £2.89

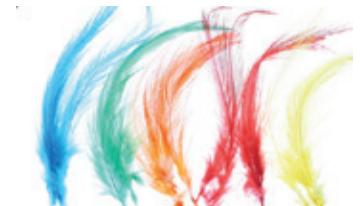

Large Cock Hackles

Ideal for lures & salmon flies.

Colours: Black, Blue, Green, Orange, Red, Yellow

Code 13199 £3.29

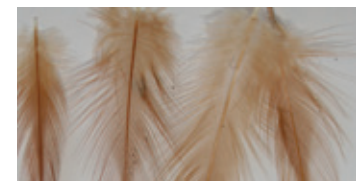

Cock Hackle Select

A wide range of natural and dyed colour hackle. The selected hackles are best for smaller trout flies.

Colours: Badger, Cree, Furnace, Ginger, Grizzly, Yellow

Code 15A0059 £2.29



Fly Tyer's Variety Pack

Each pack contains an equal mix of grizzly, natural & vibrantly dyed colours across all feather types. Maximum value for a minimum price.

Code 70167 £32.29

FEATHERS

Bronze Mallard

Ideal for mayfly wings & traditional patterns. 5 matched pairs.

Sizes: Small **£4.29**

Medium **£5.59**

Large **£7.19**

Code 13316



Mallard Butcher Blues

Provides the perfect wing for your wet flies. 10 feathers per pack.

Code 13316 £3.19

Hand Stripped Peacock Quill

Hand stripped peacock eye fibres, great for segmented bodies. 25 per pack.

Colours: Natural, Ginger, Yellow, Red, Olive, Orange.

Code 16A0144 £6.89



Cock Pheasant Back Patch

A complete cock pheasant back patch with plenty of short green back feathers all matched.

Code 15A0075 £5.29



Dyed Golden Pheasant Tippet

Collar pieces equivalent to approx half a collar. **Colours:** Purple, Hot Orange, Red

Code 80057 £8.69



Goose Shoulder

For traditional salmon fly wings.

Colours: Black, Red, Blue, Green

Code 13308 £2.99



Goose Biots

Create perfect breather filaments

Colours: Black, Brown, White, Orange,

£2.59 Assorted, Fl Assorted **£2.89**

Code 13306



Mallard Duck

Provides the perfect wing for your wet flies.

Flank: Grey 2gm **£3.29**

Wings: Per Pair **£5.69** **Code 13316**

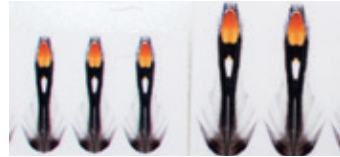

Synthetic Jungle Cock

Printed onto thin plastic sheet jungle cock substitute with a slightly tacky back which makes mounting the 'feather' a doddle. Very realistic.

Sizes: XSmall 10mm, Small 15mm, Medium 20mm

Code 12A0101 £2.89



Golden Pheasant

Complete crest (Grade 1) **£11.89**

Complete whole tail **£17.39**

Complete tippet collar **£11.89**

Whole head, crest & tippet collar **£20.99**

Code 13305



Jay Wings

Ideal for traditional wet fly patterns.

Per Pair **Code 13313 £9.99**



Woodcock Wings

Ideal for traditional wet fly patterns.

Per Pair **Code 13329 £6.69**



Teal Duck

Winging & throat hackle material

Flank: 2gm **£3.79**

Wings: Per Pair **£5.29** **Code 13328**



Stripped Quills

Beautiful dry fly & nymph bodies without the fiddle! Qty 15.

Colours: Black, Nat Brown, Nat Grey, Olive, Red, Yellow, Blue Dun

Code 13330 £2.39



Franc N Snaelda Franc N Feelers

These stripped cock hackle quills are perfect for snaelda and francis flies.

Small for double hook flies and large for tube flies. Qty 20

Colours: Yellow, Red, Orange, Black

Sizes: Small, Large

Code 19A0093 £6.29



Guinea Fowl

Body & neck hackles. **Colours:** Natural, Blue **Code 15A0032 £2.99**



Peacock Natural Eye

The perfect body material for nymphs & dries. Qty 2. **Code 13323 £3.79**



Peacock Blue Neck

A bright body or winging material.

Qty 10. **Code 13323 £3.99**

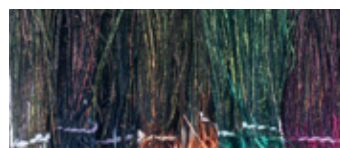

Peacock Herl

The perfect body material for nymphs & dries **Colours:** Natural, Black, Orange, Green, Magenta **Code 13323 £3.79**



Peacock Sword Tails

Required for many of the most popular nymphs & saltwater patterns. Qty 2.

Code 13323 £3.79



English Grey Partridge Selected Hackles

1g of washed mixed English partridge hackles. Plenty of useable material.

Colours: Natural, Yellow, Olive, Burnt Orange, Fl Chartreuse, Fl Pink

Code 15A0076 £4.19

French Partridge

Ideal for mayfly wings. 10 feathers per pack. **Colours:** Natural, Yellow

Code 13304

£2.89

Veniard's Boar Bristles

Hand selected, finely tapered bristles essential on many salmon flies & for mayfly tails. Qty 20.

Code 11A0160 £3.39



Marabou Plumes

The most famous winging material for reservoir flies. Qty 10

Colours: Black, Brown, Coral, Hot Orange, Med. Olive, Red, White, Fl Green, Fl Orange, Fl Sunburst Yellow, Assorted.

Code 13319 £3.29

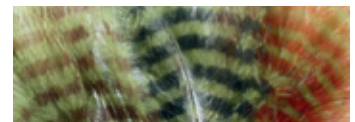

Marabou Bloods

These are short feathers with very long fine fibres.

Colours: Lt Olive, White, Yellow, Orange, Peach, Olive, Black, Fl Chartreuse

Code 27700 £3.49



Silver Pheasant Body Feathers

Depending on the pattern, silver pheasant feathers are used for hackles, wings and tails on flies.

Code 23A0084 £4.79

Ringneck Cock Pheasant

Complete Tail Natural **£5.59**

Centre Tail Qty 2

Colours: Natural, Black, Claret, Olive, Orange, Red **£3.29**

Bleached & Dyed Centre Tail

Colour: Med Olive **£3.29**

Code 13324



Knotted Tail On The Quill

Centre tail with each fibre double-knotted. **Colours:** Natural, Claret, Black, Orange, Red.

Code 13326 £5.19

Pre Tied Legs

Tie hoppers & daddies in double quick time with these pre-tied legs.

Approx 50 per pkt.

Hopper Legs:

Black, Claret, Natural

Code 13318 £2.99

Daddy Legs: Natural

Code 40004379 £2.99



Veniard's Ostrich

This material is perfect body herl for diawl bachs & all other nymphs.

Colours: Black, Med Olive

Code 13321 £4.29

ZONKERS



Veniard's Disco Zonker

Holographic tinsel is fused to the skin side of the rabbit zonker adding irresistible fish-catching flash. 3 x 10" strips per pack.

Colours: Black/Silver, Chartreuse/Gold, Natural/Gold, Olive/Gold, White/Rainbow, Red/Silver

Code 20A0159 £5.69



Rabbit Zonker Strips

Perfect winging material for zonkers & minkys. **Colours:** Natural, White, Black, Olive, Fl Pink, Fl Chartreuse

Code 13367 £4.49



Magnum Rabbit Zonker Strips

Wider cut strips for bigger flies such as Pike, Bunnies & Eel type flies. 2ft per pack.

Colours: Black, White, Red, Olive, Fl Pink, Fl Chartreuse

Code 27684 £6.09



Mink Zonker Strips

Top quality mink strips for 'minkies'. A must for the reservoir fisher.

Colours: White, Grey, Brown

Code 27704 £5.49

SCHLAPPEN



Schlappen Feathers

Webby saddle/side hackles much sought after by both classic salmon tyers & saltwater experts alike. Feature in many tarpon patterns as well as the growing number of pike patterns.

Colours: White, Black, Red, Yellow, Hot Orange, Chartreuse, Purple, Lt Blue

Code 27699 £5.69

CDC - CUL DE CANARD



Super Select CDC

Gland feathers, 15 small & 15 large feathers in each pack. **Colours:** Fiery Brown, Nat Grey, Nat Khaki, Nat White, Olive, Black

Code 10528 £3.29



CDC Combo Packs

4 popular colours of select CDC, 20 feathers per pack. **Option:** Pack 1 - Nat Grey, Olive, Fiery Brown, Light Dun Pack 2 - Nat Khaki, Nat White, Yellow, Silver Grey

Code 80054 £8.19



Bulk CDC Feathers

Great for all CDC patterns. 1gm packet. Wild duck feathers. **Colours:** Nat Grey **£7.99** White, Golden Olive, Pale Olive, Dun, Olive Dun, Black **£7.59**

Code 80055

HAIRS & FURS



Arctic Fox Tail

These Arctic fox tail pieces have been hand selected for their fur quality. Fine, long, tapered wings can be tied with the longer guard hairs in addition to the under-fur which acts as the perfect under-winging material. **Colours:** White, Black, Red, Orange, Green, Olive, Chartreuse, Sunburst Yellow, Fl Pink

Code 13360 £4.59



Grey Squirrel Tail

Colours: Dyed Black, Red, Blue, Orange, Yellow **£3.79** Natural **£2.99**

Code 27761

Assorted

Pack of 5 **Code 27761 £4.29**

Fox Squirrel Tail

Natural **Code 27762 £5.99**



Calf Tails

For all those 'Charlies' & small salmon flies. **Colours:** White, Tan, Orange, Yellow, Brown, Black

Code 27760 £8.59



Veniard's Bucktail

A very popular winging material. Whole tail. **Colours:** Natural, Black, Blue, Orange, Red, Yellow, Fl Chartreuse **£11.39**

Assorted Pack of 5 £7.59

Code 13361

Roe Deer Hair

A coarse, tough hair ideal for muddlers. Natural Colour.

Code 80067

£4.49



Deer Hair

For spinning heads on muddlers & spinning & stacking bass bugs etc.

Colours: Black, Olive **£5.99**

Nat. White, Fl Chartreuse **£7.59**

Code 27758



Veniard's Elk Hair

Medium texture 1-2.5"

Colours: Natural Gold, Dyed Black, Dyed Brown

Code 13358 £6.09



Veniard's Goat Hair

Approx. 3" long mountain goat hair on skin. **Colours:** Black, Orange, Yellow

Code 13362 £4.89



Franc N Snaelda Shadow Fox

Very mobile and soft, ideal for tying on doubles or small tubes. Also great for wings and tails on shrimp flies and temple dogs.

Colours: Black, Yellow, Hot Orange, Red

Code 19A0094 £12.99

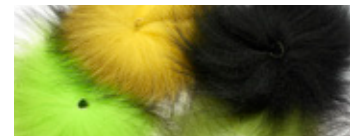

Arctic Fisherman Mutation Fox

Mutation Fox is certified Finnish fox fur with a black tip on its hair. The hairs have quite a long coarse structure, which results in a really nice wing shape. A great material for tube fly wings.

Colours: Black, Chartreuse, Green, Orange, Red, Yellow

Code 18B0044 £6.69

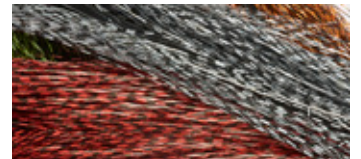

Voodoo Fibres

Made from fine 8" strands of synthetic Mylar that have been micro barred with black to give an extra illusion of movement that all fish love. Perfect for intruder and predator patterns, bonefish, poppers and nymphs. **Colours:** Blue, Chartreuse, Olive, Red, Tan, White

Code 18B0045 £5.99



Arctic Fisherman Finn Raccoon

Premium quality, real, certified raccoon from northern Finland that has all the characteristics of Arctic Runner. A super-soft fur, which creates a lovely pulsating wing with lots of movement as it glides through the water. **Colours:** Black, Chartreuse, Green, Orange, Red, Yellow

Code 18B0043 £9.39



Franc N Snaelda Supreme Goat

Supreme quality, long and soft with straight tips and under fur.

Colours: Black, Hot Orange, Blue, Yellow

Code 19A0096 £10.69



The Feather Bender's Flytying Techniques

By Barry Ord Clarke

Barry Ord Clarke's ground-breaking flytying book featuring QR codes and YouTube video links for each pattern described, providing step-by-step instruction to help you take your flytying to the next level. Hard cover. 256pp

Code 19B0030 £24.99



Chalk Streams - A unique environment worth conserving

By Dick Hawkes LRPS

An evocative and atmospheric photographic book which serves as a stunning record of this precious ecologically unique habitat and rare wildlife species found in chalk streams and water meadows. Hard cover. 164pp

Code 21B0073 £30.00



Fishing from the Rock of the Bay

By James "Leakyboots" Batty

Full of fishing anecdotes, this book charts the author's obsession with fishing, from lemon sharks in the Gambia, striped bass in New York, and salmon in British Columbia. A mixture of John Gierach and Bill Bryson, his style is wry, witty and incisive. Hard cover. 288pp

Code 22B0040 £19.99



GT

By Peter McLeod

A comprehensive guide to GT fishing on the fly, covering how to catch them, tackle and equipment, which flies to use, winning tactics and best destinations including the Seychelles, Maldives, Mauritius, Australia, South Africa, Oman, Mozambique, Sudan and many more. Hard cover. 224pp

Code 16B0001 £29.99



Destination Angler III

By Dave Lewis

Another beautifully illustrated mix of big game, small game, lure, fly and bait fishing targeting a wide range of species from all around the world. 26 illustrated chapters continue the journey of Destination Angler I & II. Hardback. 268pp

Code 22A0100 £35.00



Farlows Salmon Flies

By Martin Lanigan-O'Keeffe

An illustrated history and catalogue of the 695 pattern salmon flies of C. Farlow and Co. from 1864-1970, illustrating and recording many previously unknown or unidentified patterns. Hard cover, 360pp with colour photos.

Code 17A0002 £50.00



Little Red Book of Fly Fishing

By Kirk Deeter & Charlie Meyers

Offers a simple, digestible primer on the basic elements of fly fishing: the cast, presentation, reading water and selecting flies. One of the most insightful, plainly spoken and entertaining works on this sport. 224pp

Code 11A0311 £14.99



The Pocket Guide to Fishing Knots

By Peter Owen

Drawings of the 24 most useful knots for every fisherman, game, coarse and sea. Compact little book. 80pp

Code 10206 £5.99



Fly Fishing for Coarse Fish

By Dominic Garnett

The perfect introduction to help you start fishing for coarse fish with your fly rod. Dominic Garnett's book is full of useful knowledge, species-specific technical information, successful fly patterns and beautiful photography. Hard cover. 224pp

Code 21A0101 £20.00



Matching the Hatch - Stillwater, River & Stream

By Pat O'Reilly

This completely revised and updated pocket edition with 278 enlarged colour photos will help you choose suitable flies to match any hatch and will also suggest how to fish them in a way that will catch fish. Soft cover 224pp

Code S14A0267 £12.95

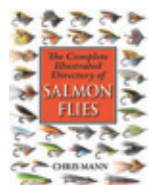

The Complete Illustrated Directory of Salmon Flies

This is the most comprehensive directory of salmon flies ever published. Respected international fly tyer author Chris Mann has been studying salmon flies and their inventors for 30 years. Soft cover with 1800 flies in colour.

Code S14A0113 £20.00



Ultimate Knot Guide

Easy to read drawings of the ten best knots printed on waterproof plastic cards. Ideal for your pocket or tackle bag. Folds out to a 12 inch ruler.

Code 11552 £7.99



How to Flyfish

By John Symonds

John's clear and attractive book shows you all the essential skills you need to become a competent, all-round flyfisher. Covers all topics from knot tying to casting and how to fish for trout or salmon from a boat or the bank. Hard cover 88pp

Code 14A0608 £9.99



Flycasting Skills

By Symonds & Maher

This clear illustrated guide shows you all the casts you will ever need, from basic overhead to Spey casts and from roll casts to flamboyant snake casts. Colour illustrations. Hard cover. 96pp

Code 13A0122 £14.99



How to Catch More Salmon

By Henry Giles

Think and catch more fish is a central theme but to enjoy the sport via more nuanced and philosophical aspects is key. Get it, teach it and share it, in the UK and Ireland but also on the rivers of Norway, Canada and Russia. Hard cover. 166pp with colour photographs.

Code 19A0147 £25.00



A Fine Line: Loch Style Fishing from Bank and Boat

By George Barron

George shares his thoughts and wisdom on loch style fishing from boat and bank, fly tying, the past, the future and, of course, loads of George's irresistible fly patterns. Hard cover. 162pp

Code 20A0160 £25.00



Fly Tying for Beginners

By Barry Ord Clarke

In this exceptionally clear and easy-to-use beginner's guide Barry shows you exactly how to create a dozen universal fishing flies, step-by-step. Each of the 12 patterns is linked by QR code to a YouTube video showing Barry tying the fly in question. Hard cover. 127pp

Code 21B0046 £14.99



Fifty Places to Fish Before You Die

By Chris Santella

Maps out the meccas of the fly fishing world for both armchair travellers and avid outdoorsmen. 40 colour photographs. Hard cover. 224pp

Code 10201 £18.99



North Country Fly

By Robert L Smith

Robert L Smith reveals the fascinating history of traditional trout & grayling flies of the North of England, including examples of actual flies & materials with images from original manuscripts. This beautifully illustrated book tells the definitive story of the North Country Fly. Hard cover 312pp

Code 15A0084 £35.00



Trout Bum

By John Gierach

A fresh look at fly fishing and the way of life that grows out of a passion for it. The people, the places, and the accoutrements that surround the sport make a fishing trip more than just a set of tactics and techniques. A masterpiece from a master storyteller and a fisherman! Hard cover and 238pp

Code 13A0173 £28.99



Not Really Fishing

By Denise Ashton and Theo Pike

Riverside moments, stories and fascinating facts about trout and other river wildlife written by wild trout anglers. All profits go to the Wild Trout Trust. Soft cover. 103pp.

Code 22A0102 £5.99

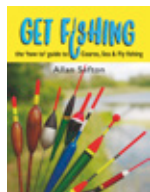

Get Fishing

By Allan Sefton

This colourful book is aimed at complete beginners of all ages and it has everything you need to know about the basics: species, tackle, bait, tactics and watercraft. Endorsed by the Angling Trust and the Environment Agency. Hard boards. 128pp with colour photographs.

Code 19B0032 £9.99

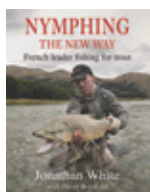

Nymphing - The New Way

By Jonathan White

The use of ultra-long tapered French leaders is an important new development in fly fishing and provides huge advantages. This is the first book of its kind to explain all branches of French leader techniques and is a must read for anyone. 160pp

Code 16B0002 £19.99



The Song of the Solitary Bass Fisher

By James "Leakyboots" Batty

James fishes from the rocks and beaches near his Cornish home and catches bass with lures, flies and bait. He is generous with his knowledge and full of fresh ideas. His real focus is on understanding bass behaviour then using this to work out the place time and method. Hard cover. 192pp

Code 18B0059 £16.99



The Fish of a Lifetime

By Matt Harris

Legendary fly fishing photojournalist Matt Harris' first ever book, a simply stunning 656 page anthology that packs decades of entertaining editorial features and award-winning photography into one huge coffee table volume.

Code 23A0100 £99.99

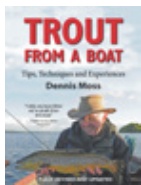

Trout From a Boat

By Dennis Moss

Few trout anglers have fished as widely as Dennis Moss. Here he conveys the top tips and techniques of modern boat fly fishing with incredible insight and passion. Soft cover. 192pp

Code S14A0110 £15.99



Mullet on the Fly

By Colin Macleod

Mullet are tricky to catch and are fast becoming one of the UK saltwater fly fisher's most sought-after species. In this book, Colin Macleod shares techniques, fly patterns and the secrets to success. Hard cover. 304pp

Code 21A0103 £30.00



Pocket Guide to Matching the Hatch

By Peter Lapsley & Cyril Bennett

For the fly fisher who has witnessed trout rising all around but not known which fly to put on, here is an essential pocket guide to matching the hatch. 96pp

Code 10070 £8.99



Hooked on Lure Fishing

By Dominic Garnett

The ultimate guide to lure fishing gives you the lowdown on all the latest lures, tackle and techniques to enjoy this exciting branch of angling from the tiniest streams to the open coast. Hard cover. 224pp with colour photographs.

Code 19B0031 £24.99



Sea Trout - Tips, Tricks & Tribulations

By Steffan Jones

A masterpiece that covers all aspects of sea trout fishing from daytime to night-time, through to weather considerations and more. Contributions from Moc Morgan, Martin Joergensen and others from around the world who have discussed their favourite patterns. Hard cover. 244pp with colour photos.

Code 19B0044 £30.00

SPECIAL OFFER

Scott Mackenzie's Spey Casting Masterclass DVD

Using the latest technology, World champion Scott shows you how to master the perfect cast, from the basics to his own world beating techniques. 83min.

Code 60572 £15.99

WAS £24.99 NOW £15.99

RIO's Favourite Fly Fishing Knots DVD

RIO's instructional guide to 29 of the most popular fly fishing knots. Each tied with highly visible materials and a contrasting background making it easy to see every detail. 103min.

Code 17B0085 £19.99

RIO Modern Spey Casting DVD

Clear, concise instruction from the very basics of Spey casting to top tips for the advanced caster. 3 DVDs with 4 hours of footage.

Code 70206 £49.99



Essential Patterns - Quick Ties and Favourite Flies (Volume 1)

Oliver Edwards takes you through this step-by-step guide to the art of fly tying and introduces you to the techniques you need to tie his six favourite flies. 170min.

Code 22A0103 £9.99



Essential Patterns - Woven Flies (Volume 2)

Oliver Edwards shows you how to weave fly bodies using a variety of thread traps, bights, return locks and knots in the five most important weaving techniques. 195min.

Code 22A0104 £9.99



DVD 1: Czech Nymphing

Learn all the secrets of 'Czech Nymphing'. Details the methods of upstream nymphing as well as how to fish North Country Spiders. 177min.

Code 25521 £9.99



DVD 2: Search & Sight Fishing

Learn how to search fish for trout & grayling on clear waters of Southern chalkstreams. Oliver gives good advice on entomology & details his method for fishing swirling pools. 120min.

Code 25521 £9.99



DVD 3: Fishing Dry Fly on a Chalkstream

Learn about dry fly fishing, mayflies and become a better chalkstream fisherman. In this DVD, Oliver demonstrates entomology, tying, and fishing imitative patterns. 120min.

Code 25521 £9.99



DVD 4: Wet Fly Fishing on Rivers

Skills & techniques taught; Down & Across, Square Across, the Escalator. Patterns shown; march brown, greenwell's glory, Stewart's black spider, yellow spider. 105min.

Code 70183 £9.99



DVD 5: Big Dry Flies for Fast Water

Skills and techniques explained include: fishing The Edwards Bluebottle, Klinkhammer, line control, leader make up for the 'Duo' or 'Klink & Dink'. 142min.

Code 70183 £9.99



DVD 6: Streamer Fishing on Rivers

Techniques for anglers, including entomology, tying and fishing imitative patterns. Learn how to design & tie flies & cast against the current. 122min.

Code 70183 £9.99



SAVE £5.00 WAS £14.99 NOW £9.99



Sakura Bidaia Travel Spinning Rods

A range of value for money 4-piece travel spinning rods that are suitable for use in both fresh and saltwater. These rods feature light and sensitive blanks yet have subtle fast actions.

Key Features

- Quality IM24T carbon blanks
- Anti-tangling stainless frame SiC rings
- Ergonomic reel seat
- Ergonomic, high density EVA handle
- Solid, durable travel case

Code 20A0113

Model	Length	Sections	Casting Weight	Price
704ML	7'0"	4	3-10g	£89.99
704MH	7'0"	4	7-28g	£89.99
804H	8'0"	4	10-40g	£94.99
904XH	9'0"	4	14-60g	£98.99

FROM
£89.99



Abu Tormentor Spinning Rods

A thin, moderate-fast actioned travel rod that is ideal for all-round spinning and predator fishing.

Key Features

- Powerful 24T carbon construction
- Slim blanks with semi-progressive action
- Quality LTS SiC guides
- Premium grade cork handle
- Ergonomic reel seat
- Supplied in a luxury rod sleeve

Code 22A0094

Length	Sections	Casting Weight	Price
6'0"	3	4-12g	£34.99
7'0"	3	5-18g	£41.99
8'0"	4	8-24g	£44.99
9'0"	4	15-45g	£52.99
10'0"	5	25-65g	£62.99

FROM
£34.99



ABU Diplomat V2 Spinning Rods

A superb, value for money, 4-piece spinning rod, convenient for the travelling angler. Made from high quality 24-ton graphite with a wooden reel seat, attractive cork handle and quality SS304 guides. Supplied with a sturdy, zipped, cordura carrying tube. The 4 sizes available cover everything from perch to salmon or pike.

Code 22B0043

Length	Sections	Casting Weight	Price
7'0"	4	3-14g	£59.99
8'0"	4	5-21g	£64.99
9'0"	4	12-32g	£79.99
10'0"	5	12-32g	£89.99

FROM
£59.99



Abu Salmo Seeker 4-Piece Spinning Rods

Designed and built for the travelling salmon angler but equally applicable for any lure fisherman looking for a quality, value-for-money rod. These rods are built on medium-light, crisp actioned blanks with LS guides throughout and traditional length upper and lower AAA cork handles. Supplied with a hard protective travel tube.

Key Features

- Convenient 4-piece rod
- Medium-light action
- Traditional AAA cork handles
- LS guides
- Hard Cordura covered tube

Code 14A0104

Length	Sections	Casting Weight	Price
9'0"	4	12-28g	£109.99
10'0"	4	15-32g	£129.99

FROM
£109.99



Shakespeare
SINCE 1897

Shakespeare Ugly Stik Travel Spin

The four-piece Ugly Stik Travel Spin rod at 6ft 6ins is great for all spinning and lure requirements. With an exclusive slim diameter these spinning rods are ideal for perch and trout. Supplied in a compact protective tube of only 22" it packs neatly into a suitcase ready for your next fishing adventure.

Key Features

- Exclusive slim blank construction
- Graphite reel seat fitting
- Single leg lined guides
- Comfortable EVA handle
- Overside joints
- Supplied in a 22" protective Tube

Code SP16A0006

Length	Sections	Casting Weight	Price
6' 6"	4	5 - 15G	£49.99



SHIMANO®

Fuji DPS reel seat with EVA handle

Strong double leg Shimano hardlite guides

Shimano STC Powergame Rod - Two Lengths & Twin Tips

Designed for the travelling big saltwater fish angler and built on a XT60+ biofibre blank with a super-fast action and immense power and strength. Supplied with two tips for multi-length versatility. Shorter (2.0m) for powerful boat fishing 150-300g. Longer (2.5m) for casting large lures 40-120g.

Key Features

- XT60+ Biofibre blank
- Fuji DPS reel seat with EVA handle
- Strong double leg Shimano hardlite guides

Code 18B0059

Length	Sections	Casting Weight	Price
2.0m / 2.50m	5 (2 Tips)	150-300g / 40-120g	£214.99



SHIMANO®

Quality abbreviated cork handle

XT60+ X5 Nano Alloy blank

Shimano STC Travel Spin Rods

Featuring XT60+ X5 nano carbon material these rods are really lightweight, strong and responsive with a fast action.

Key Features

- XT60+ X5 Nano Alloy blank
- Shimano custom designed DPS reel seat
- Quality abbreviated cork handle
- Single leg Shimano hardlite guides

Code 18B0011

Model	Length	Sections	Casting Weight	Price
240M	8'0"	4	10-30g	£119.99
270MH	9'0"	5	15-40g	£134.99
300H	10'0"	5	20-60g	£149.99



SAVAGE GEAR

Seaguide® CCS stainless steel guides with SIN rings

Japanese Toray blanks

FROM £74.99

Competition ready-to-fish rod bags

Savage Gear SG2 Rod Series

A complete range of Savage Gear SG2 lure fishing rods, with superb balance, feel and design. Light and strong Japanese Toray carbon blanks with Coil Control guides for precise and effortless casting. Ergonomically designed EVA handles, rubber cork non-slip butt caps with quality competition reel seats. Supplied in ready-to-fish rod bags.

Key Features

- Japanese Toray blanks
- Seaguide® CCS stainless steel guides with SIN rings
- Competition double lock carbon reel seats
- Competition ready-to-fish rod bags

Code 21A0099

Model	Length	Sections	Casting Weight	Price
Ultra-Light Game	6'6"	2	2-8g	£74.99
Light Game	7'3"	2	5-18g	£74.99
Medium Game	7'1"	4-Travel	10-40g	£99.99
Medium Game	8'0"	4-Travel	14-40g	£99.99
Medium Game	8'1"	4-Travel	15-45g	£109.99
Power Game	8'0"	4-Travel	40-110g	£109.99

Sportfish Recommends...

SPECIAL OFFER

RRP £119.99
NOW £99.99

Can be used in either fresh or saltwater

Stainless steel guides with zirconium coated inserts



Abu Max® X Casting Combo

A superb, value for money rod & reel combo that can be used in fresh or saltwater with either braid or monofilament. The new compact Max® reel with its lightweight, graphite frame and body includes a 5+1 bearing system with a smooth retrieve and a strong drag. The reel is left-hand wind only. The medium-fast action 6ft 6ins 2-piece rods feature an EVA handle with an Abu designed reel seat and stainless steel guides with zirconium coated inserts.

Code 21B0054

Length	Sections	Casting Weight	Reel Capacity	RRP	Price
6'6" M	2	10-40g	0.29mm/135m	£119.99	£99.99

Reel is left-hand wind only

RRP £119.99 NOW £99.99 SAVE £20.00



Versatile rod with quality components

Abu Tormentor "Ready-to-Go" Spinning Outfit

The Abu Garcia Tormentor ready-to-go spinning outfit is designed for the all-round predator and spinning angler who is looking for a versatile rod with quality components at an affordable price. The outfit consists of an Abu Tormentor 4-pce rod together with a quality Abu Tormentor 5+1 bearing, front drag reel which is pre-spooled with Berkley Fireline Ultra 8 braided line.

Code 20B0060

Length	Sections	Casting Weight	Braid mm/kg	Outfit Price
8'0"	4	8-24g	0.17mm/10.7kg	£119.99
9'0"	4	7-28g	0.20mm/13.9kg	£129.99
10'0"	4	12-36g	0.20mm/13.9kg	£139.99



Perfect for anglers looking for a reliable spinning rod and reel

Shakespeare Firebird "Ready-to-Go" Spinning Outfit

The Shakespeare Firebird "Ready-to-Go" spinning outfit is perfect for anglers looking for a reliable spinning rod and reel without breaking the bank. The outfit consists of a Shakespeare Firebird 2-pce rod matched with a Shakespeare Firebird rear drag spinning reel pre-loaded with Shakespeare monofilament.

Code 21B0052

Length	Sections	Casting Weight	Mono lbs	Outfit Price
7'0"	2	10 - 25g	6lbs	£34.99
8'0"	2	10 - 40g	6lbs	£34.99
9'0"	2	20 - 80g	6lbs	£34.99

SHIMANO®

Shimano Stella SWB

The up graded Stella features X-Protect and X-Shield for ultimate saltwater protection, X-Tough drag for more power and adjustment control and X-Rigid gear combined with X-Ship for maximum winding power and efficiency.

Code 14A0521

Model	Capacity	Gear Ratio	Bearings	Price
8000PG	0.37mm/275m	4.9:1	14	£989.00
10000PG	0.40mm/300m	4.9:1	14	£989.00
18000HG	0.53mm/310m	5.7:1	14	£1084.00

“The Ultimate Saltwater Spinning Reel.”

X-Tough drag for more power and adjustment control



X-Protect and X-Shield for ultimate saltwater protection



SpiderWire Stealth Smooth 8 Braid
SEE PAGE 215

Shimano Stradic FL

The updated and redesigned Stradic FL is the ideal all-round, strong and reliable spinning reel. Upgraded features include smoothness due to the MicroModule II Silent Drive, strength due to the Hagane Gear X Protect and casting performance due to the long stroke spool. Approved for light saltwater, it delivers both corrosion resistance and durability.

Code 19B0014

Approved for light saltwater



Model	Capacity	Gear Ratio	Bearings	Weight	Price
1000 HG FL	0.20mm/140m	6.0:1	6+1	185g	£204.00
2500 HG FL	0.25mm/160m	6.0:1	6+1	225g	£204.00
3000 HG FL	0.25mm/210m	6.0:1	6+1	225g	£209.00
4000 XG FL	0.30mm/180m	6.2:1	6+1	260g	£219.00
5000 XG FL	0.35mm/175m	6.2:1	6+1	265g	£229.00

Shimano X-Aero RA Baitrunner

The Shimano X-Aero RA Baitrunner, with its large diameter spool, achieves outstanding casting results. This upgraded reel also features Aero Wrap II with 2 speed oscillation. Single handle on 8000 and 10,000 sizes and double handle on 6000 size.

Code 14A0586

Black satin finish



Large diameter spool, achieves outstanding casting results

Model	Capacity	Gear Ratio	Bearings	Price
BTXAR 6000RA	0.30mm/320m	4.6:1	8+1 Roller	£199.00
BTXAR 8000RA	0.35mm/290m	4.6:1	6+1 Roller	£204.00
BTXAR 10000RA	0.35mm/380m	4.6:1	6+1 Roller	£204.00

Shimano Saragosa SW

The Saragosa SW is an affordable heavy duty saltwater reel that can handle the punishment of modern jugging and spinning. Packed with the best Shimano features including X-Ship and HD gear. The Saragosa SW also features X-Shield waterproof body and drag to protect it from the harsh saltwater environment. The smaller sizes are perfect for casting, spinning and jugging whilst the 20000 is perfect for large bluewater game fish.

Code 14A0523

X-Shield waterproof body and drag to protect it from the harsh saltwater environment



Perfect for large bluewater game fish

Model	Capacity	Gear Ratio	Bearings	Price
8000SW	0.40mm/230m	5.6:1	5+1	£249.00
20000SW	0.62mm/240m	4.4:1	5+1	£339.00

Shimano Baitrunner ST

The Baitrunner ST is packed with far more features than you would expect to find on this entry level Baitrunner.

Line lay is immaculate thanks to Shimano's unique varispeed system.

- Classic black hybrid aluminium body
- "Varispeed" line lay
- Dyna balance

Code 24053

Classic black hybrid aluminium body



Dyna balance

Model	Capacity	Gear Ratio	Bearings	Price
BTRST 4000FB	0.35mm/130m	4.8:1	1+1 Roller	£74.99
BTRST 6000RB	0.30mm/270m	4.6:1	1+1 Roller	£79.99
BTRST 10000RB	0.35mm/350m	4.6:1	1+1 Roller	£84.99



Full metal body and sideplate



Superline Spool

CNC Gear™ technology

Penn Battle® III

Penn's Battle III series has a model for every angler and is now stronger, smoother and even more durable than ever before. By matching Penn's CNC Gear™ Technology, HT-100™ carbon fibre drag system and a full metal body, the Battle III has the guts and drag to handle serious abuse.

- Full metal body and sideplate
- CNC Gear™ technology
- HT-100™ carbon fibre drag
- 5+1 sealed stainless steel bearings
- Line capacity rings
- Superline spool

FROM
£109.99



Code 20B0057

Model	Capacity	Gear Ratio	Bearings	Price
1000	0.23mm/95m	5.2:1	6	£109.99
2000	0.28mm/115m	6.2:1	6	£119.99
2500	0.31mm/130m	6.2:1	6	£129.99
3000	0.36mm/150m	6.2:1	6	£129.99
4000	0.36mm/150m	6.2:1	6	£139.99
4000HS	0.36mm/150m	7.0:1	6	£139.99
5000	0.46mm/125m	5.6:1	6	£139.99
6000	0.56mm/210m	5.6:1	6	£149.99

Enhanced gear ratios

Thicker, stronger and more durable bail arm



Penn Spinfisher VI

The Spinfisher VI Series has many improved features, such as an IPX5 watertight design which protects the full metal body, the gearbox and drag system. The line capacity rings on the braid-ready superline spool always lets you know how much line is left.

- Full metal body
- Thicker, stronger and more durable bail arm
- Infinite anti-reverse
- Friction trip ramp prevents premature bail trip when casting
- Stainless steel main shaft and alloy main gear
- Enhanced gear ratios

Code 19A0074

Model	Capacity	Gear Ratio	Bearings	Price
3500	285yds/8lb	6.2:1	6	£149.99
4500	320yds/10lb	6.2:1	6	£159.99
5500	330yds/12lb	5.6:1	6	£169.99
6500	345yds/15lb	5.6:1	6	£184.99
7500	330yds/20lb	4.7:1	6	£194.99
8500	310yds/30lb	4.7:1	6	£204.99

Full metal body and sideplate



Instant anti-reverse

8+1 stainless steel bearings

Penn Clash™ II

The Penn Clash™ II is the ultimate inshore saltwater reel. Featuring Penn's CNC Gear™ Technology, HT-100™ carbon fibre drag system, hydrophobic line roller bearing and the Clutch Armor System to ensure protection in all weather conditions. The Leveline® Slow Oscillation System ensures perfect line lay, cast after cast.

- Full metal body and sideplate
- Instant anti-reverse
- 8+1 stainless steel bearings

Code 20B0058

Model	Capacity	Gear Ratio	Bearings	Price
3000	0.36mm/150m	6.2:1	9	£259.00
4000	0.36mm/150m	6.2:1	9	£279.00
5000	0.46mm/125m	5.6:1	9	£299.00

2-shielded stainless steel ball bearings

Instant anti-reverse bearing



Penn Wrath™

The Penn Wrath™ is built around a lightweight and corrosion resistant graphite body with a machined and anodised aluminium spool and features Penn's legendary durability.

- 2-shielded stainless steel ball bearings
- Instant anti-reverse bearing
- Line capacity rings

Code 22A0095

Model	Capacity	Gear Ratio	Bearings	Price
2500	0.28mm/160m	6.2:1	3	£54.99
3000	0.31mm/150m	6.2:1	3	£54.99
4000	0.31mm/200m	6.2:1	3	£59.99
5000	0.38mm/185m	5.6:1	3	£59.99
6000	0.46mm/210m	5.6:1	3	£69.99

SHIMANO®



Shimano Nexave FE

The updated Nexave FE features a multidisc drag and is perfect for a wide range of freshwater fishing situations. The Nexave FE has an aluminium spool with AR-C line management and varispeed line lay for great casting accuracy. The fast 4.9:1 retrieve ratio gives you great control over powerful fish. Also features Super Stopper II, Dyna-Balance and Power Roller.

Code 18B0061

Model	Capacity	Gear Ratio	Bearings	Price
NEX6000FE	0.35mm/240m	4.9:1	3+1 Roller	£79.99



Abu Cardinal SWi (Saltwater)

This saltwater resistant reel delivers outstanding versatility, dependability and exceptional value for money. Stainless steel components are matched with four high performance corrosion resistant bearings, couple this with serious winding power and you have the complete saltwater reel.

- 4 HPRC bearings
- Instant anti-reverse
- Stainless steel main-shaft and hardware
- Spare spool
- Stealth oscillation

Code 15A0289

Model	Capacity	Gear Ratio	Bearings	Price
176 SWi FD	0.35mm/220m	5.1:1	4	£54.99

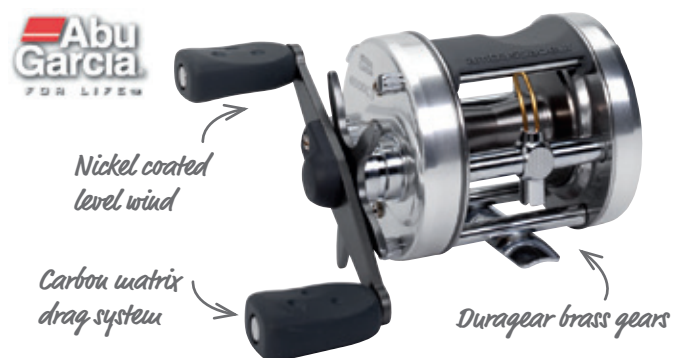

Abu Ambassador Classic C3

The world's best selling baitcasting reel with its Swedish engineering and reputation for durability.

- Nickel coated level wind
- 3 stainless steel bearings
- Six pin centrifugal braking
- Carbon matrix drag system
- Duragear brass gears

Code 27747

Model	Capacity	Gear Ratio	Bearings	Price
6501 C3 LHW	0.40mm/200m	5.3:1	2+1	£229.00
6500 C3 RHW	0.40mm/200m	5.3:1	2+1	£229.00



Strong graphite body and rotor



Abu Cardinal® X

Abu Cardinal® X spinning reels are reliable, smooth and affordable. The 4-bearings make the reel rotation light and smooth, with a strong smooth front-controlled drag while the strong graphite body and rotor protect the zinc alloy internal parts.

- Smooth strong front drag
- Aluminium spool and foldable handle
- Anti-slip rubber paddle grip
- Strong graphite body and rotor
- Anti-Reverse on/off lever

Code 21B0053

Model	Capacity	Gear Ratio	Bearings	Price
Cardinal X 1000	0.23mm/100m	5.2:1	3+1	£39.99
Cardinal X 2000	0.25mm/120m	5.2:1	3+1	£43.99
Cardinal X 3000	0.25mm/150m	5.2:1	3+1	£43.99
Cardinal X 4000	0.35mm/110m	5.2:1	3+1	£44.99
Cardinal X 5000	0.40mm/100m	5.2:1	3+1	£47.99

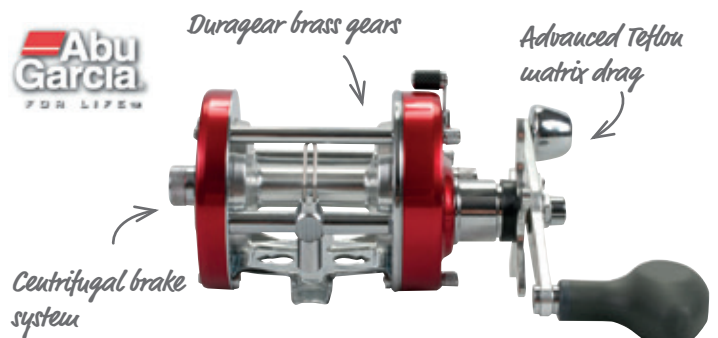

Abu Ambassador 7000

These reels feature synchronised level wind and a 6 washer Teflon drag. Constructed with durable, bushing, precision brass gears and a corrosion resistant anti-reverse bearing. Left hand or right hand wind.

- Centrifugal brake system
- Bush bearings
- Level wind
- Duragear brass gears
- Advanced teflon matrix drag

Code 12A0049

Model	Capacity	Gear Ratio	Bearings	Price
7001 LHW	0.45mm/270m	4.1:1	Bushing	£159.99
7000 RHW	0.45mm/270m	4.1:1	Bushing	£159.99

MITCHELL



Mitchell MX3 Baitcasting

An affordable, low-profile baitcasting reel with high specifications including 5 bearings, one-piece graphite frame and EVA handle knobs. The 11-setting centrifugal braking system helps to determine the exact brake settings for casting different lures. Left-hand wind only.

Code 22A0096

Model	Capacity	Gear Ratio	Bearings	Price
MX3LP-L	0.35mm/100m	6.4:1	5	£59.99

SAVAGE GEAR



Green Silver



Rainbow



Golden Albino

4D Line Through Trout

The 4D trout has an unbelievably lifelike enhanced 4D-photo chrome fish skin print and a carbon 49 wire line thru trace. Each lure colour has been tested and tuned and a strike triggering scent has also been added to ensure explosive takes from predatory fish.

Colours: Rainbow, Golden Albino, Green Silver

Size: 15cm / 40g

Code 17B0052 £14.99



3D Suicide Duck

A super realistic 3D-scanned duckling top water lure that will fool the most wary predators with its strong ABS body and semi soft and durable spinning feet.

Colour: Natural Duckling

Size: 10.5cm / 28g

Code F17A0060 £17.99



Gravity Stick Kit (30+17pcs)

A slim-profile, long-casting range of soft lures with a high specific gravity. All the lures have a rattle slot in the main body plus an insert weight slot in the tail area to add even more distance to your cast if required. Kit contains 30 soft lures and 17 hooks and accessories all in a lure box.

Code 20B0071 £29.99



Roach



Firetiger



Rudd

3D Pulse Tail Roach

Super realistic details based on the scan of a real roach. The Pulse Tail delivers a subtle ultra-realistic action at slow, medium and even high speed. The lure has a built-in steel rattle chamber and when twitched it sends out an attack-provoking loud clicking sound. The lure sinks and swims on the drop. 2 per pack.

Colours: Roach, Firetiger, Rudd

Sizes:

10cm / 17.5g **£13.99 2 pack**

13cm / 38.5g **£15.99 2 pack**

Code 20A0115



Olive Pearl



Fire Tiger

4D Real Eel

The iconic Real Eel lure, now with amazing 4D colours with lamprey skin print and added strike triggering scent. The eel swims with a big lively curl tail kicking action – both on steady retrieve and the drop, triggering brutal attacks from predatory fish.

Colours: Firetiger, Black Green Pearl

Size: 20cm / 38g

Code 20A0114 £11.99



Dropshot Academy Kit (36 pieces)

A great dropshot kit perfect for perch fishing. This kit contains 24-different shads, minnows and crayfish together with 6-dropshot hooks and 6 dropshot weights.

Code 23A0105 £22.99



Roach



Perch



Firetiger



Golden Ambulance



4-D Line Through Roach

A jointed soft lure body with incredible 4D colour detail. They can be twitched and pulled and swim with an amazing S-curve action.

Colours: Roach, Perch, Firetiger, Golden Ambulance
18cm / 80g **£15.99**

Code 23A0104



Sandeel Kit (25pcs) 57646

A great kit comprising a mixture of sandeel tails and jig head hooks, all in realistic sizes. The kit contains 20 assorted sandeel bodies and 5 jig head hooks.

Code 19A0073 £29.99



Cannibal Shad Kit (36 pieces)

A 36-piece kit perfect for a variety of predatory fish. The kit contains 30-assorted 6.8cm and 8.0cm Savage Gear cannibal shads and 6-jighead hooks.

Code 23A0106 £22.99

Rapala



Jointed® Floating

Lively action triggers strikes from neutral fish. Gets fantastic results after a cold front, when fish are traditionally finicky and in a negative feeding mood.

Colours: Silver (S), Blue (B), Brown Trout (TR), Firetiger (FT), Hot Tiger (HT)

7cm/5g - **£9.69** 9cm/7g - **£11.29**

11cm/9g - **£12.29** 13cm/18g - **£13.29**

Code 12035



Countdown®

Slow sinking controlled depth technique. The original countdown is slow sinking to reach fish lying at any depth.

Colours: Bleak (ALB), Gold Fluoro Red (GFR), Brown Trout (TR)

5cm/5g - **£9.49** 7cm/8g - **£10.19**

9cm/12g - **£10.79** 11cm/16g - **£11.29**

Code 12034



Max Rap®

Aerodynamic shape balanced with tungsten balls for maximum casting distance and accuracy. The ultimate UK bass lure.

Colours: Baby Sea Bass (BSBL), Sardine (BSRDL), Blue Mackerel (SBML)

11cm/13g - **£13.79** 13cm/15g - **£14.89**

Code 10222



Original Floater®

The first and still the number one 'go-to' lure. With its wounded fish action the original floating continues to be irresistible to game fish all over the world.

Colours: Gold (G), Bleak (ALB), Gold Fluoro Red (GFR), Brown Trout (TR), Firetiger (FT)

7cm/4g - **£10.49**

9cm/5g - **£10.59**

11cm/6g - **£11.29**

Code 12033



X-Rap®

The adrenaline-pumping X-Rap slashbait has Xtreme attitude with its hard cutting aggressive darting action. The integrated long-casting system partners with an irresistible rattle and classic Rapala action. It suspends and comes to a roll at rest to trigger the bite.

Colours: Hot Pink (HP), Live Perch (PEL), Parrot (PRT), Rusty Crawdad (RUCW), Yellow Perch (YP)

8cm/7g - **£10.99**

10cm/13g - **£11.99**

Code 27896



MaxRap® Walk'n Roll

An active topwater lure that spits, bobs, skitters and slides across the surface in all conditions.

Colours: Flying Fish (HDFFU), Red Head (HDRHU), Mullet (MUL)

10cm/13g - **£15.49**

13cm/29g - **£16.89**

Code 23A0099



X-Rap® Long Cast Shallow

A long casting, heavily weighted lure with an aggressive darting baitfish action just sub surface and then flutters on the drop. Fitted with VMC® In-Line single hooks.

Colours: Red Head (RH), Blue Mackerel (BM)

12cm/36g - **£16.19**

14cm/53g - **£17.79**

Code 20B0073



X-Rap® Countdown®

Count down and fish at any depth consistently and reach suspended fish at any depth. Swims with a strong rolling action on the retrieve and flutter on the pause.

Colours: Live Roach (ROL), Live Rainbow Trout (RTL), Silver (S), Brown Trout (TR)

5cm/4g - **£10.79**

7cm/10g - **£11.49**

Code F17A0264



Halco Max

This cutting edge, bib-less minnow can do the lot: jigging, casting or trolling. The highly streamlined design gives unbeatable casting ability while allowing trolling speeds up to 12 knots. The slender tail section is designed for maximum hooking with super-strong Mustad hooks.

Colours: Redhead (H53), Lime (H81), Chrome Tiger (R49), Pilchard (H50)
Size: 110mm/30g **£13.39**, 130mm/80g **£15.99**
Code 18A0124



Halco Roosta Popper

The unique head design makes this lure ideal for "blooping", popping or straight retrieving. The built-in rattle and super-wide mouth ensure plenty of noise to attract the biggest fish. Fitted with super-strong Mustad hooks.

Colours: Pink Fluoro (R1), Chrome Tiger (R49)
Size: 80mm/16g **£12.59**, 105mm/30g **£12.99**
 135mm/49g **£13.89**, 160mm/75g **£17.39**
 195mm/117g **£31.99**
Code 18A0125



Halco C-Gar

This weighted stick bait is designed for use on or sub-surface with a less splashy action than a popper. The unique nose design ensures long casting and enough surface action to entice a strike from predatory fish. Fitted with super-strong Mustad hooks.

Colours: Chrome Tiger (R49), Paddy (R42),
Size: 120mm/40g **£14.89**
Code 18A0126



Halco Outcast

A baitfish-profiled, rear-weighted, long casting metal lure designed to catch a wide range of species. The aggressive swimming action is highly appealing to hungry predatory fish.

Colours: Green, Redhead, Blue
Sizes: 20g **£7.29**, 40g **£9.49**, 60g **£11.49**,
 80g **£12.49**
Code 18A0127



Halco Twisty Chrome

The curved ends of this incredibly realistic, baitfish-profiled, metal lure create an enticing action like no other from a slow wobbling to a high-speed splashing retrieve.

Sizes:
 10g - **£5.79**
 15g - **£6.59**
 20g - **£7.49**
 30g - **£8.79**
 40g - **£10.59**

Code 18A0128



Rapala X-Rap® Magnum® Casting Lure

The -Rap® Magnum® Casting Lure is built heavy, solid and aerodynamic for extreme casting and durability in demanding saltwater conditions.

Colours: Anchovy (ANC), Red Head (HDRHU), Blue Mackerel (HDSBM), Wahoo (HDWHU)
 10cm / 42g - **£18.99**
Code 23A0103



Berkley PowerBait Pike Pro Pack

A selection of three 15cm swimming mullet softbaits and matching jigheads. These softbaits are perfect for large pike when slowly retrieved past weed beds and snags.

Code 12A0089 £11.99



Pulse Shad Mix Box with Jigheads

All your favourite colours of 6cm pulse shad ready to fish and already pre-PowerBait scented. Supplied in a handy tacklebox which includes matching jigheads. 24 (20+4) piece kit.

Code 22A0099 £29.99



Berkley PowerBait Perch Minnow Pro Pack

This assortment of 4 x 6cm pulse-shads and 4 x 7.5cm minnows, together with 3 x (3.5g, 5g, 7g) jighead hooks is ready to catch perch or any predatory fish anywhere. Shake and twitch the minnows to imitate small prey fish and fish the pulse-shads slowly around snags and structures.

Code 19A0125 £11.99



Berkley PowerBait Drop Shot Pro Pack

An assorted selection of the best dropshot baits and everything else you need to make your own rigs including weights, special hooks and stingers together with clear instructions. Perfect for catching trout, pike, zander, perch, bass and any other predator that swims in fresh or saltwater.

Code 12A0043 £11.99



Berkley PowerBait® Pro Pack Minnow

A perfect assortment of 3" and 4" PowerBait® minnows – Two each (one 3" and one 4") of the five most popular colours together with two weighted jig hooks. The universal shape of these PowerBait minnows will catch the attention of all freshwater predators without exception. Jig them fast and slow!

Code 21B0055 £11.99

Berkley All Round Jig Heads

Lightweight Jig Heads fitted with seriously sharp Owner hooks.

Colours: Olive (O), Fluoro Orange (FO)
Sizes: 3.5g Pack 6, 4.7g Pack 5, 7g Pack 5
Code 12A0047 £9.99



Irish Rubber Tails

This is based on the original lure made by Robert Gillespie, the famous Irish ghillie.

- Gold plated blades
- Durable latex rubber
- VMC® treble
- Compact lure: short body, for better hooking



Standard Blade

The standard blade type is suitable for all types of water.

Code 12043 £3.49

Hammered Blade

This thinner, slimmer blade is designed for fast water.

Code 12044 £3.49

Wasp

Silver blade, black body and yellow tail.

Code 12046 £3.49

Ladybird

Silver blade, black body and red tail.

Code 12045 £3.49

SH - Single Hook Some models are available with single hook.

Single Hook Code: 15A0452 WASP Single Hook Code: 15A0453

Weight	Black/Gold	Black/Silver	Black/Copper	Red/Gold	Red/Silver	Red/Copper	Yellow/Gold	Ladybird	Wasp
STD 7g	•	•	•	•	•	•	•	•	•
STD 10g	• SH	• SH	• SH	•	•	•	• SH	•	• SH
STD 15g	• SH	• SH	• SH	•	•	•	• SH	•	• SH
STD 20g	• SH	• SH	• SH	•	•	•	• SH	•	• SH
STD 24g	-	•	-	-	-	-	-	-	-
STD 28g	-	•	-	-	-	-	-	-	-
HAMM 10g	•	•	•	-	-	-	-	-	-
HAMM 15g	•	•	•	-	-	-	-	-	-

Two-part machined brass main body eliminates line twist



Super strong and sharp VMC® hooks

Blue Fox Vibrax Original

The legendary Blue Fox Vibrax® is back.

- Two-part machined brass main body eliminates line twist
- Rattling, free-turning brass gear with stainless steel shaft
- Super strong and sharp VMC® hooks
- 45° blade runs 0.5 – 1.2 meters deep

Code 20B0009

Size / Weight	Copper	Silver	Gold
#0/3g	£3.65	£3.65	£3.65
#1/4g	£3.65	£3.65	£3.65
#2/6g	£3.99	£3.99	£3.99
#3/8g	£3.99	£3.99	£3.99
#4/10g	£4.85	£4.85	£4.85
#5/13g	£5.29	£5.29	£5.29

Rattling, free-turning brass gear with stainless steel shaft



Abu Toby Spoons - Lead Free

- One of the best-selling lures in the world
- Non symmetrical body gives a unique fluttering action to drive fish wild
- Lifelike fish design
- New lead-free manufacture
- *40g silver & copper only

Code 21B0048

Weight	Length	Price
7g	5.7cm	£4.99
10g	5.7cm	£5.99
15g	7.5cm	£6.99
18g	9.0cm	£8.49
20g	7.5cm	£8.49
28g	9.0cm	£9.49
40g*	9.0cm	£9.49



Abu Toby Salmo

The original Scottish salmon lure! Heavier than a standard Toby to cast further and cut through swells and fast flowing rivers with ease. 30g.

Colours: Silver or Copper

Code 15A0042 £8.49

Classic Toby 3-Pack

This money saving pack contains one each of Silver, Blue Flash and Red Hot Tiger Tobys.

10g - **£15.99** 12g - **£16.99**

18g - **£19.99** 20g - **£19.99**

Code 21B0049

Rolla Silver Bullet Spinners

At last, the 'Rolla Silver Bullet' is now available in the UK. These lures have a cult following amongst salmon anglers in Ireland and France. Made of the finest quality components, including Owner® hooks.

Colours: Black/Silver, Black/Copper, Black/Gold, Pink/Silver, Pink/Copper, White/Silver

Sizes: 11g, 16g or 22g

Code 10087



	Black & Silver	Black & Copper	Black & Gold	Pink & Silver	Pink & Copper	White & Silver
11g	£6.99	£6.99	£6.99	-	-	-
16g	£6.99	£6.99	£6.99	£6.99	£6.99	£6.99
22g	£6.99	£6.99	£6.99	£6.99	£6.99	£6.99

LURES



Mepps

Aglia Colours: Silver, Gold, Copper
Code 12028

Aglia Comet Colours: Silver with Blue spots, Gold with Red spots, Silver with Red spots
Code 12029

Aglia Long Colours: Silver, Gold, Copper
Code 12030

Size	Aglia	Aglia Comet	Aglia Long
1	£3.25	£3.49	£3.99
2	£3.25	£3.49	£3.99
3	£3.25	£3.99	£4.99
4	£4.49	-	-



Abu Reflex Reds (Lead Free)

- Unique waffle blade design for enhanced reflection
- Superb two tone colours with marabou feathers

Colours: Silver, Copper, Zebra
Sizes: 7g - **£5.99** 12g - **£6.99** 18g - **£8.49**
Code 10532



Classic Killer Plugs

A deadly salmon and pike plug that has been around for years with a classic diving and wiggling action. Includes hooks and mold.

Colours: Black & Gold, Yellow Belly
Sizes: 3.5 inch/13g
Code 12A0122 £8.49



Classic Devon Minnows

These minnows are superbly balanced, always ensuring correct presentation. They are moulded in one piece and will not crack or split. Supplied fitted with a mount and hooks. Floating or sinking.

Colours: Black & Gold, Green & Yellow, Blue & Silver
Sizes: 2 inch or 3 inch
Code 12A0121 £3.49



Classic Atlantic Spoons

Great for salmon and other predatory fish in both freshwater and the sea. The fluttering action and the hammered finish make these spoons irresistible.

Colours: Copper, Silver, Copper/Silver
Sizes: 3-10g, 5-21g
Code 12A0123 £4.49

BRAIDED SPINNING LINES

Power Pro

Made from braided Spectra to produce an extremely strong, abrasion resistant, fine diameter line with almost zero stretch. Power Pro has a smooth rounded profile that means it casts further, is not hard on line guides and cuts in less on the spool. Specially coated to make it 10x stronger than steel. 300yds.

Colours: Moss Green, Yellow or White
Code 25312



Dia (mm)	0.15	0.19	0.23	0.28	0.36	0.41	0.46
Kg	9	13	15	20	30	40	55
Lb.	20	29	33	44	66	88	121
Moss Green	£34.99	£34.99	£34.99	£34.99	£34.99	£34.99	£44.99
Yellow	£37.99	£37.99	£37.99	£37.99	£37.99	£39.99	£49.99
White	£37.99	£37.99	£37.99	£37.99	-	-	-

SpiderWire® Dura-4 Braid

A smooth, thin, strong, sensitive and durable 4-carrier braid that is not super expensive.

Colour: Low Vis Green
Code 17B0061



Dia (mm)	0.12	0.17	0.25
Kg	10.5	15.0	23.2
Lb.	23	33	51
300yds	£29.99	£29.99	£29.99

SpiderWire Stealth Smooth 8 Braid

A tight-woven, 8 carrier braided line, made in the USA. Stealth smooth has a tight weave with a micro coating for smooth, quiet casting, improved strength and shock resistance with less tangles.

Colours: Moss Green or Yellow
Code 20A0048



Dia (mm)	0.13	0.15	0.19	0.23	0.29	0.33
Kg	12.7	16.5	18.0	23.6	26.4	38.1
Lb.	28	36	40	52	58	83
300yds	£43.99	£43.99	£43.99	£43.99	£43.99	£43.99

Berkley® Whiplash® 8

A perfectly round, smooth and quiet, braided 8-carrier, 100% PE, superline. Whiplash reliability you can trust for the biggest fresh or saltwater specimens.

Colour: Green
Code 17B0062



Dia (in)	0.06	0.08	0.10	0.12
Lb.	24	28	32	38
300yds	£47.99	£47.99	£47.99	£47.99

SPINNING LINES

Maxima

Maxima is one of the most reliable tippet materials available. Great knot strength and abrasion resistance makes this one of the most popular leader materials.

Code 11304



Dia (mm)	0.30	0.32	0.37	0.40	0.42
Lb.	10.0	12.0	15.0	18.0	20.0
200m Chameleon	£10.99	£10.99	£11.99	£11.99	£13.49
600m Chameleon	£22.99	£24.99	£24.99	£24.99	£24.99

Berkley Trilene® XL®

The bestselling Trilene® XL® has got even better, stronger and smoother. The new improved formula has 20% greater knot strength and is 20% more flexible than before

Code 21B0057



Dia(mm)	0.20	0.22	0.24	0.26	0.28	0.32
kg	3.5	4.4	5.2	5.8	7.0	8.5
Lb.	7.0	9.0	11.0	12.0	15.5	18.0
Price	£8.49	£8.49	£8.49	£8.49	£8.49	£8.49

Berkley® Trilene® 100% Fluorocarbon 150m

This professional grade fluorocarbon is the first 100% fluorocarbon good enough to be called Trilene®.

- 100% Invisible fluorocarbon
 - Superior strength and smooth handling
- Code 21B0056**



Dia(mm)	0.28	0.32	0.35	0.38
Lb.	13.0	17.0	22.0	25.0
kg	5.9	8.0	10.0	11.3
150m	£18.99	£18.99	£18.99	£18.99

Berkley Big Game Monofilament - Green

One of the most popular monofilaments in USA due to its incredible strength, reliability and value. Extreme fighting power for big game fish, saltwater or freshwater.

- Super strong for confidence and control
 - Shock resistant with controlled stretch
 - Extra tough and abrasion resistant
- Code 11A0361**



Dia (mm)	0.35	0.38	0.45	0.48	0.55	0.60
Kg	5.4	6.8	9.0	11.3	13.6	18.1
Lb.	12	15	20	25	30	40
Length(yds)	1175	900	650	595	440	370
Price	£12.99	£12.99	£12.99	£12.99	£12.99	£12.99

TRACES AND LEADERS



Sportfish Deluxe 12" Spinning Traces

Quality 12" steel wire traces, hand tied with ball-bearing swivels and coastlock clips.

Size: 100lb Deluxe

Code 24695 £4.99



Halco Supa Snap 11" Traces

Black nylon coated 7-strand stainless steel wire with strong rolling swivel and a crosslock snap.

Qty/Pack: 6

Sizes: 20lb - **£13.49** 30lb - **£13.49**

60lb - **£15.99** 100lb - **£16.99**

Code 12A0133

Savage Gear Black7 Wire Traces

An ultra-strong 7-strand stainless steel wire traces coated with a strong black copolymer for superb abrasion resistance and with quality snap links and swivels. Pack of 3.

Three sizes available: 7kg/20cm, 11kg/30cm and 25kg/40cm

Code F17A0068 £4.49



WIRE LEADERS



American Fishing Wire - Surlon

A remarkable, knottable 49 strands camo nylon coated steel wire leader. 5m spools.

Sizes: 20lbs, 26lbs, 40lbs

Code 11A0033 £17.99



RIO Wire Bite Tippet

Tippet Tough, flexible nylon coated wire. Supple enough to tie on a fly with. 5m spools.

Sizes: 20lbs, 30lbs or 40lbs

Code 12A0031 £19.99



Savage Gear Raw 49-Strand Knottable Wire

An uncoated, quality, stainless steel 49-strand wire (7x7) which is soft, flexible, easy to knot and has very little memory. Natural Brown. 10m spools.

Sizes: 24lbs, 35lbs or 50lbs

Code 17B0064 £12.99



Partridge Surlon Spinning Traces

Heavy-duty 18inch surlon wire traces with high quality sleeves, swivels and lock snaps. Pack of 3.

Qty/Pack: 3

Sizes: 20lbs, 30lbs

Code 19A0120 £7.99



Partridge Pike Tech Leader Wire - W49

Knottable, flexible, sensitive and pliable nylon coated 49-strand stainless steel wire. Ideal as leader wire for all toothy predators. Camo. 5m.

Sizes: 30lbs, 40lbs

Code 18B0040 £10.99



SNAPS

Partridge Predator Fast Snaps

Designed for rapid lure and fly change with the minimum of fuss. Multi-twist for added security with an offset eye to ensure perfect lure action. 3 sizes. Pack of 15.

Sizes:

- Size 0 - 15lbs
- Size 1 - 25lbs
- Size 2 - 60lbs

Code 21B0051 £2.49



Berkley McMahon Cross-Lok Snap Swivels - Black

Extra-tough quality stainless steel swivels brass plated swivels with a non-flash black finish with a secure Cross-Lok clip.

Code 15A0284



Size	BS	Pack Qty	Price
Size 12	30lbs	Pk 5	£2.29
Size 10	40lbs	Pk 5	£2.29
Size 7	60lbs	Pk 4	£2.29
Size 5	80lbs	Pk 4	£2.29
Size 3	100lbs	Pk 3	£2.29

LEAD FREE WEIGHTS

Dinsmores Pierced Bullets / Ball Legers

Non-toxic and lead-free

Code 21A0098 £2.99



Weight	Size	Pack	Price
2g	7.9mm	Pack of 12	£3.25
6g	12.7mm	Pack of 10	£3.25
12g	15.9mm	Pack of 6	£3.25
20g	19.1mm	Pack of 5	£3.25

Dinsmores Arlesey Bomb

Non-toxic and lead free with an integral swivel.

Code 12041 £2.99



Weight (g)	Weight (oz)	Pack	Price
10g	3/8oz	Pack of 4	£3.25
14g	1/2oz	Pack of 4	£3.25
22g	3/4oz	Pack of 3	£3.25
30g	1oz	Pack of 2	£3.25

SPLIT SHOT

Non-Toxic, Twin-Cut, Split Shot

Non-Toxic, super-soft, twin-cut split shot that slides easily onto your line and hangs centrally. Large 7 division shot dispenser (SSG, AAA, BB, No1, No4, No6 & No8). Refills available in sizes SSG, AAA, BB and No1.

A Dispenser

Code F17A0040 £9.99

B Refills

Code F17A0041 £2.20



SWIVELS AND SNAPS

Partridge Power Swivels

These tiny 100% stainless steel crane swivels are smaller and 3x stronger than conventional brass swivels. Ideal for wary fish and where size matters. 10 per pack

Sizes: 45lbs, 65lbs, 80lbs

Code 18B0060 £2.49



Berkley Ball Bearing Swivels with Snaps

Strong smooth hard wearing ball bearing swivels with secure coastlock clips.

Sizes:

- Size 2 - 25lbs - 3pk
- Size 3 - 30lbs - 3pk
- Size 4 - 100lbs - 2pk
- Size 5 - 175lbs - 2pk
- Size 6 - 275lbs - 2pk

Code 13A0142 £4.99



Berkley McMahon Swivels - Black

Exceptionally strong, rust proof, brass plated swivels with a non-flash black finish.

Code 15A0285



Size	BS	Pack Qty	Price
Size 12	35lbs	Pk 10	£2.29
Size 10	40lbs	Pk 10	£2.29
Size 7	60lbs	Pk 8	£2.29
Size 5	80lbs	Pk 6	£2.29
Size 3	100lbs	Pk 6	£2.29

Cox & Rawle 3-Way Brass Swivel

Cox & Rawle 3-way quality brass cross line swivels. 30lb.

Pack of 8.

Code 21B0050 £2.49



WORMING

Bouncing Bomb Set (Worm Controller)

Six 7cm clear plastic tubes with attached swivels, together with 12 different interchangeable weights allow control of the speed of the bait in any water. Also very effective with floating Devons or Rapalas.

Code 10047 £14.99



Partridge Baitholder Hook

A bronze, down-eyed, beaked hook with bait holding slices on the shank. The perfect hook for worming and other applications. 10 hooks per packet.

Sizes: 4, 6, 8, 10

Code 19A0118 £3.99



RINGS & SNAPS

Partridge InLine Single Hooks

A versatile, strong InLine single hook with a big eye. Ideal to replace treble hooks on lures. The extra wide gape ensures improved hook ups. Available barbed or barbless.

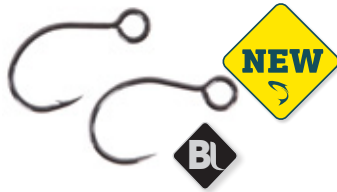

Code 23A0110

Size	1/0	1	2	4	6
Hooks per Pack	7	10	10	10	10
Barbed	£5.99	£5.99	£5.99	£5.99	£5.99
Barbless	£5.99	£5.99	£5.99	£5.99	£5.99

Savage Gear Stainless Steel Split Rings

Strong, reinforced and forged stainless steel split rings. 10-black and 10-silver = 20 per pack.

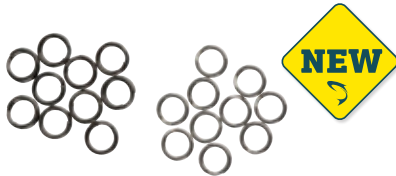

Code 23A0109

Size	4.0mm	5.0mm	5.5mm	6.0mm
lbs	24lbs	44lbs	59lbs	77lbs
Rings per Pack	20	20	20	20
Price	£3.99	£3.99	£3.99	£3.99

Halco Fish Rings - Split Rings

These consist of three thicknesses of stainless steel wire and are 70% stronger than standard split rings.

Sizes:

Size 3 - 15kg - **£3.39** pk18

Size 4 - 35kg - **£3.99** pk18

Size 4XX - 66kg - **£3.99** pk18

Code 12A0203



TACKLE BOXES

Abu Tackle Boxes

Lure boxes various sizes available.

Lure Box Mini - **£4.99**

Lure Box Spinner - **£5.99**

Lure Box Spoon - **£6.99**

Lure Box Wobbler - **£9.99**

Code 22583



Leeda Lure Cases

These double sided lure cases are the perfect solution to storing and protecting your expensive lures. They have drainage holes to allow saltwater to be washed off and they also have saltwater-resistant locking clasps.

Code 19A0081



Model	Size	Compartments	Price
Medium	20 x 16 x 4.5cm	10	£9.99
Medium	27.5 x 16 x 4.5cm	14	£10.99
Large	27.5 x 18 x 4.5cm	14	£11.99

Leeda Compartment Boxes

These compartment boxes are great for storing your lures.

Code 19A0105



Model	Size	Compartments	Price
Small	18.5 x 10.5 x 3.0cm	6	£3.99
Medium	18.0 x 11.5 x 3.0cm	10	£3.99
Large	19.0 x 13.8 x 3.8cm	14	£3.99

PLIERS

Loon Apex HD Pliers

The perfect companion for any outing involving big flies and big fish. Constructed of lightweight aluminium, housed in a durable rubber sheath and secured with a coated steel tether. The entire system can withstand salt, neglect, heavy use and abuse.

Code 23A0046 £109.99



Halco Fish Ring Pliers

Designed by Halco specifically for changing split rings without stretching the ring. Made from hardened tool steel and work with split rings from tiny #3 right up to heavyweight #7.

Code 15A0202 £25.99



Simms Flyweight Pliers

Weighing only 4.25oz these pliers feature a unique ergonomic shape and are made with a corrosion resistant anodised aluminium body and stainless steel jaws and cutters. They include a secure utility leash and a convenient durable holster for attaching to 38mm wading belts or braces and Simms' flyweight hexsystem. Handmade in Montana, USA.

Colours: Orange, Titanium

Code 21B0018 £174.99



Sportfish Needle Nosed Pliers

A handy pair of 6" high quality pliers. Ideal for smaller hooks and for cutting wire up to 30lbs.

Code 27710 £12.99



Sportfish 8" Pliers

Superb quality pliers, ideal for pike and saltwater fishing. Great for taking out hooks and for cutting heavy mono and wire.

Code 265452 £14.99



Loon Rogue Quick Draw Forceps

Probably the very best haemostat on the market. Well thought out and designed from the tips to the jaws, to the clip-on carabiner handle. An essential fly fishing tool.

Code 17B0037 £29.99



Sportfish Debarbing Pliers

Strong stainless steel construction, flat faced fine nosed pliers, with integral clippers.

Colours: Gold or Black.

Code 11485 £10.99





Shakespeare Seat Box

An upgraded version of the best waterproof seat box available. Built from tough, durable polypropylene with a twin catch locking system to keep your tackle safe and dry. Supplied with a side tray and a carrying shoulder strap.

Size: 51cm x 38cm x 40cm

Code 19A0124 £79.99



Includes 4 x large and 1 x medium boxes

Berkley Midi Ranger Bag

The Berkley Midi Ranger Bag is made from tear proof 850-denier material with rust proof zips and Velcro® pockets. It is designed so that the tackle boxes can be stored either horizontally or vertically. Includes 4 x large and 1 x medium boxes.

Code 16B0041 £89.99

Fully neoprene padded seat and back rest



Wychwood Flow Pack-lite Stool

A unique storage solution that doubles as a comfortable chair. The lightweight, aluminium, collapsible stool features a neoprene padded seat and back rest. There is one large main pocket with dual entry from front or back and multiple smaller pockets. Supplied with a comfortable padded shoulder strap.

Size: 56cm x 28cm x 28cm

Code 13A0049 £64.99



Yeti LoadOut GoBox 30 Gear Case

This gear case is virtually indestructible and fully submersible. Great for camping storage, first-aid kits, as a tackle box or protecting camera equipment. It is built to withstand serious impact, perfect for stacking and has a removable cargo tray, divider, and compartment for organisation.

Colour: Charcoal

Size: External Dimension 51.8 x 37.6 x 28.7cm

Internal Dimension 45.0 x 30.0 x 22.1cm

Code F23A0179 £250.00

Yeti LoadOut Bucket

Ultra-durable and designed for lugging, loading, bailing, and stepping. The bucket walls are twice as thick as conventional buckets and are made of rigid HDPE plastic, built not to bow, break down or crack with impact. Condensation and pressure will never build up between buckets when stacked, which means they'll always separate easily. The LoadOut bucket also features UV protection for long term durability, is food safe and has a Bearfoot™ non-slip ring that will not slide or leave marks. Please note: This product is not a cooler.

- Capacity 18.9L / 5 US gallons
- Empty Weight: 2.4kg

Colour:Tan

Code F21A0330

£39.99

Compatible accessories also available:

LoadOut Bucket Caddy

A lift out caddy that fits inside the bucket

Code F21A0110

£19.99

LoadOut Bucket lid

Code F21A0109

£29.99



Zenith Tackle Box

- The Zenith box has a large deep top storage section and 4 trays that slide out. All with adjustable sections
- Designed to be strong enough to sit on, it has a convenient carry handle on top making it the perfect mobile tackle box.

Size: 40 x 29 x 42cm

Code 10275 £105.99



PLANO®

Plano Waterproof SlowAway® Boxes

Quality waterproof boxes with a Dri-Loc® O-ring seal, three cam-action waterproof latches and numerous adjustable compartments.

Code 22A0093 £64.99

Size	Compartments	Price
35.6 x 22.9 x 7.6cm	4-23	£22.99
35.6 x 22.9 x 5.1cm	4-23	£13.99
27.3 x 18.4 x 4.4cm	5-20	£10.99
23.2 x 12.4 x 3.8cm	3-18	£9.49



Three Drawer Tackle Box

Made with saltwater-resistant clips and fittings.

- Large top area for reels etc.
- 3 x Lure boxes included
- Adjustable shoulder strap

Size: 44 x 23.5 x 32.5cm

Code 12A0318 £44.99



Deep Multi Compartment Box

Handy box with multiple adjustable compartments

- Deep enough for large lures – 80mm deep
- Saltwater proof
- Adjustable compartments

Size: 35.5 x 23 x 8cm

Code 12A0317 £12.99

Meet The Team



DANNY R NORTH

General Manager

Danny has been fishing for over 40 years and has travelled the world in pursuit of many species of fish. He has visited Arctic Russia and North America in pursuit of salmon and has enjoyed saltwater fly fishing in destinations such as Cuba, Venezuela and North Carolina. Danny is our expert on Sage and Simms products and has visited both companies for extensive training.



STEVE HUNT

Assistant Manager

Steve describes himself as an all-round angler, but is happiest with a fly rod in his hand. Over the years he has been lucky enough to fish such destinations as Cuba, Belize, Australia and Norway to name but a few.



JOSH BUNNING

Sales Advisor

Josh is an enthusiastic trout fisherman and spends his time on both rivers and stillwaters chasing brown and rainbow trout. Josh has great knowledge of all types of trout fishing and will be happy to pass on his experience to both beginners and seasoned anglers.



CHRIS RYAN

Buying & Catalogue Manager

Chris has a keen interest in all types of game angling having fished all around the world. Chris is our big game, saltwater spinning and Irish salmon and sea trout expert.

WINFORTON. MAIL ORDER & RETAIL SUPERSTORE

Great Location

Our Winforton store is based near Hereford, in the Wye Valley, one of the most beautiful areas in the UK, close to Hay-on-Wye. Come and view our entire product range all under one roof and then try any rod on our 30m casting pool. We also have access to the River Wye at Whitney Court for you to try salmon rods by prior arrangement only. Easy parking, hot coffee and a warm welcome always come as standard.

Expertise and Products

We carry an extensive range of products in stock at all times. We have the very best in game fishing tackle on display, from rods and reels to clothing and waders. We pride ourselves on being able to offer all the help you will need to select the correct tackle for you, wherever you will be fishing. All of our experienced fishing advisors have been fortunate to have fished many destinations around the world and are always happy to answer your queries, give advice, and have an excellent knowledge of local waters including the rivers Wye and Usk. Our award winning internet and mail order service is second to none and we endeavour to get all orders despatched within one business day.

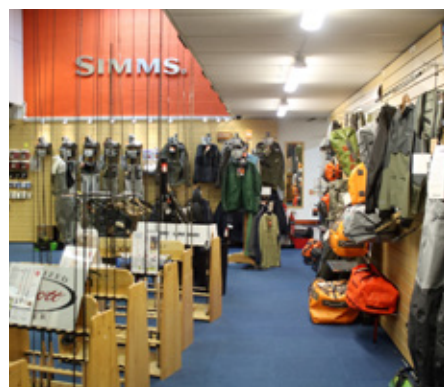
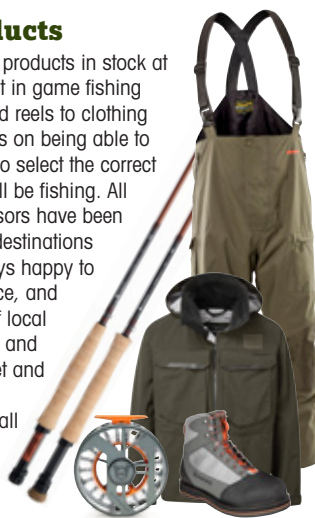

How to find us

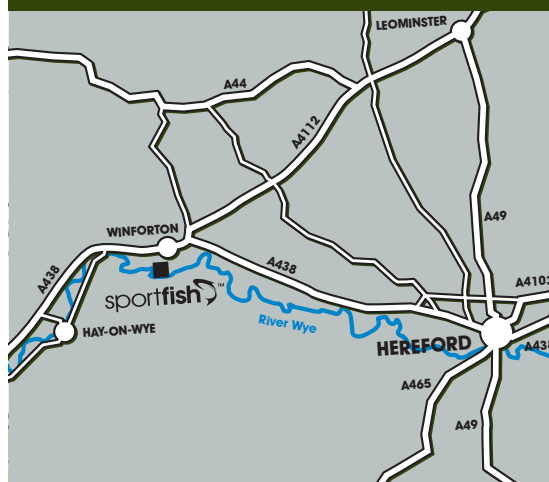

Our Address

Winforton, Hereford HR3 6SP

We are situated on the A438 between Hereford and Brecon in the pretty village of Winforton, close to the famous river Wye.

Opening Times

Monday-Friday 9am-5pm, Saturday 9am-3pm

Contact Us

Email: sportfish@sportfish.co.uk

Tel: 01544 327 111



30m casting pool

SPORTFISH TRADE-IN PROGRAM



We all want to use the best kit and get the most from our fishing. However, each season technological improvements in rods, reels, and other equipment seem to get faster and faster.

Sometimes it's difficult to justify "trading up", especially if you bought a new rod or reel just a few seasons ago and it's still in good condition and working fine. At Sportfish we want you to enjoy every minute you spend fishing. If you really want that new piece of kit then we are here to help you get it.

Our approach is simple and straightforward:

1. Come in and see us and bring the rod or reel that you would like to trade-in with you. If this is not practical call our mail order centre on 01544 327111.
2. We will consider a trade-in deal on any good quality rod or reel that is made by a premium brand eg. Hardy, Sage, Guideline, Orvis, Loomis, Loop, Abel, Waterworks Lamson, Nautilus, Tibor etc.

It must be in good condition, and have a reasonable resale value. We can also sort out minor repairs if required.

3. We've been running this trade-in program for a long time so we've already worked out the best price we can offer for a wide variety of rods and reels. For items that are not already on our trade-in list we can usually work out a price quickly.

4. You tell us what you what want to buy and we'll do our very best to offer a great trade-in on that new product.
5. Assuming we can agree a deal, we will take your old tackle off your hands, and you will be the proud owner of the latest and best rod or reel available.
6. We will then clean up and sell your old item in-store or online.

It really is that simple, so come and talk to us.

We won't always be able to help but we'll certainly try our best. Assuming we can help, you'll get great new kit at a reduced cost, you'll feel good about recycling, and somewhere a fellow angler will be very happy to take on your old tackle.

Everybody wins.



Join The Conversation!

Keep in touch with us, let us know what you are doing and become involved with our busy social network communities. Online you will find like-minded enthusiasts, great competitions, latest news, event details, exclusive features, videos and much more.



facebook.com/sportfishuk
facebook.com/gamefishingcentre
facebook.com/farlowsuk



@sportfishuk
 @gamefishinguk
 @farlowsuk



instagram.com/sportfishuk
instagram.com/gamefishingcentre
instagram.com/farlowsuk



youtube.com/sportfish
youtube.com/farlows

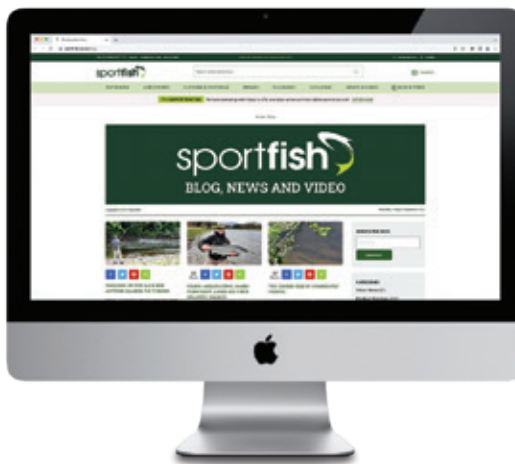

Follow our blogs

www.sportfish.co.uk/blog and www.farlows.co.uk/blog showcase a wealth of news, features, product tests, tips and video content, both from our own teams and from experts in a variety of disciplines.

SPORTFISH GAME FISHING CENTRE

Meet The Team



JONATHAN RANDALL
Manager



CHRIS HAYWARD
Tuition Manager



JONATHAN TOMLINSON
Sales Advisor/Instructor



ROBIN ELWES
Sales Advisor/Instructor



SIMON BEDWELL
Sales Advisor

For ALL your game fishing requirements

Our 1500 sq. ft. showroom showcases the very best the game fishing world offers, with the latest tackle from all the leading manufacturers. Whatever your budget, we've got the best products for it.

Staff expertise

Our staff have a vast knowledge of every aspect of game fishing, both in the UK and abroad, and are more than happy to help, advise and discuss any requirements you may have.

Try before you buy

The lake right next to the shop allows you to try rods before you buy and avoid any purchasing mistakes before they happen – you will probably get some free tips in the process too! We also part exchange rods and reels to ensure you can always keep up with the latest developments in the sport.

Lessons and tuition

Right outside our showroom is the fantastic 12-acre Haywards Farm Lake, with casting platforms both above and below the water, allowing you to perfect every cast from a single-handed overhead to the more technical snake rolls and snap T's.

Our casting instructors: Chris, JT and Robin, are available to deliver the very best in fly casting instruction and game fishing tuition. Whether you're an absolute beginner, an improver or an experienced angler looking to sharpen up before a trip, we can tailor a lesson to your exact requirements.

As well as hourly lessons and group tuition we provide beginner's stillwater days and introduction to and improver fly tying courses. We also offer tailored junior tuition on Kingfisher Pond.

On-site tuition tariff

One-to-one fly casting lessons
£50.00 per hour. Under 16s £25.00 per half hour which includes one free fish to keep.

Group (2-4 people) fly casting lessons
£85.00 per hour.

One-day stillwater trout course
Maximum 4 people per course £175.00 per person.

Fly tying course
Three-hour course. £125.00 per person

For further information on all tuition and courses, or to book places, please call: 0118 930 3860, email: tuition@sportfish.co.uk or visit: www.sportfish.co.uk/tuition

Fishing

Why not christen your new gear on Haywards Farm Lake? It's stocked with fish well into double figures and with catch and release options it's the perfect way to make a day of your time with us. Better still, spend £1.50 in-store and your day's catch and release fishing is free of charge!

Opening Times

Tuesday-Saturday 9am-5.30pm, closed Sunday and Monday.

Our Address

Station Road, Theale, Reading, Berkshire RG7 4AS
3 minute drive from junction 12 on the M4.

Contact Us

Email: sportfish-reading@sportfish.co.uk
Tel: 0118 930 3860

How To Find Us



Game Fishing Superstore



Test out a new rod



Browse our extensive stock

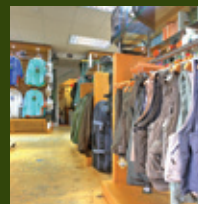

Upgrade your fishing outfit

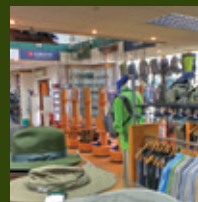

The best brands

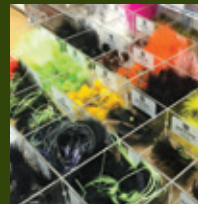

Huge fly selection





OUR FISHING

Set amidst 45 acres of delightful Berkshire countryside the Sportfish Game Fishing Centre offers fishing of the very highest quality on two lakes and one small beginner's pool.

Haywards Farm Lake

Our 12-acre day ticket water is spring fed and crystal clear, with an abundance of fly life that makes for exceptional sport. The superbly sculpted landscaping allows for excellent access and unimpeded casting. Bays, promontories, reed-fringed margins and variable depths afford a variety of different fishing opportunities. Regular stocking is with a mix of high quality, full-finned rainbows with a good proportion of blue and brown trout. The fish average around 3lb, with plenty in the 5lb to 8lb range, and there is a good head of doubles with rainbows to over 13lb and browns to 15lb. There is ample free parking and a lodge offering a lounge area, kitchen, toilet facilities, drinks vending machine, microwave, fridge and outside picnic and barbeque areas. All our tickets include catch and release fishing once the catch limit is met.

Haywards Farm Lake ticket prices	Price
Full day catch & release (C&R)	£40.00
2 fish + C&R	£45.00
3 fish + C&R	£50.00
4 fish + C&R	£55.00

A maximum of 2 children under 16 can fish free of charge, sharing a fully paid adult ticket.

Hobby Lake

This exclusive 5-acre lake is available for private hire for parties of 2-10 fishermen. It's a perfect venue for friends and family to get together, or on which to stage small corporate events. Spring fed, crystal clear and full of fly life, it offers superb floating line fishing with nymphs and dry fly and is stocked with rainbow, blue, brown, golden and tiger trout to double figures. The lake is always rested between bookings, so is not heavily fished, giving you every chance of a red letter day. The price includes exclusive use of Hobby Lake, Hobby lodge, barbeque facilities, with up to 4 fish retained per person. We supply all you need for a blissful day, all you have to bring is your own food and drink.

Hobby Lake prices exclusive use of the lake		Price
2 anglers	8 fish	£250.00
3 anglers	12 fish	£325.00
4 anglers	16 fish	£400.00

Additional anglers (to a maximum of 6 – maximum total group size 10) £75.00 each.

All fish must be taken up to the party limit, thereafter, catch and release on Haywards Farm Lake.

Kingfisher Pond

Encouraging youngsters to engage with nature conservation and learn about fishing and the wider aquatic environment is challenging but Sportfish, in conjunction with the Environment Agency, has done just that with the creation of Kingfisher Pond. Planted with a diverse range of native aquatic plants and stocked with young trout it is a key part of the Sportfish tuition scheme to benefit both youngsters learning to fish and those simply looking to explore the aquatic environment.

Fishing lessons on Kingfisher Pond cost £25 and last for 30 minutes. A parent or guardian must be present at all times if the fisher is under 16 years of age. The session includes fly casting tuition with one of our instructors and one trout to take home. If you wish to catch and keep further fish during the session, these may be purchased at £4.95 per lb (454g). If you just want to fish the pond, without a lesson, the cost is £5.00 per day. All trout must be retained and will be charged at the rate above.

Trout species we stock:



SHOP WITH CONFIDENCE

SPORTFISH GUARANTEE

All of your purchases are covered by our comprehensive guarantee. Should you have any problem at all with any of your purchases please do not hesitate to contact us and we will do our best to put things right.

REFUND AND EXCHANGE POLICY

We will gladly exchange or refund your unused purchase if you return it to us in a saleable condition and in its original undamaged packaging within 28 days of receipt. Your receipt or proof of purchase will be required.

INSURANCE CLAIMS

Sportfish has specialist knowledge in the handling of insurance claims for loss or damage to any products shown in our catalogue. In the first instance please contact our advisers who have extensive insurance knowledge and will help you with the speedy resolution of your claim.

BUY ONLINE! WWW.SPORTFISH.CO.UK

Making a purchase could not be easier, or more secure. Just browse our catalogue online, click on items that you wish to buy and click to place them into the shopping basket. After you have finished your shopping, click on "checkout". You will then be asked for a few details that we will use to fulfill your order. We accept the following credit and debit cards as payment for online purchases:



ONLINE SHOPPING

We only charge you when we ship, we do not charge your credit card for any item until it is ready to ship.

Back Orders: If your item is not in stock, we will back order it for you. You will only be charged for your back orders when they are sent (no additional postage is charged on back orders).

Fast Delivery: We will dispatch orders placed before 3pm GMT on the same day. UK customers can expect their purchases to arrive in 1-3 working days.

WORLDWIDE SHIPPING

International customers will be pleased to know we can arrange delivery of your purchases worldwide. We will only charge you what it costs to send the goods to you. International orders are generally delivered in approximately 10-14 days depending on country.

PEACE OF MIND - CREDIT CARD SECURITY

Once on our systems, all sensitive data is secured using the same internationally recognised 256-bit encryption standards used by, among others, the US Government. The encryption keys are held on state-of-the-art, tamper proof systems in the same family as those used to secure VeriSign's Global Root certificate, making them all but impossible to extract. The data we hold is extremely secure and we are regularly audited by the banks and banking authorities to ensure it remains so.

Our payments partner, Braintree, is a validated Level 1 PCI DSS compliant service provider. All transactional cardholder data is managed in the Braintree Vault, using multiple encryption keys with split knowledge and dual control. You may be assured that your cardholder data is safe and that any would-be data thief could not make use of any information stolen from a database without also having the key and this data store cannot be connected to via the internet.

PRIVACY POLICY

Here at Sportfish we take your privacy seriously and will only use your personal information to administer your account and to provide the products and services you have requested from us.

SHOPPING BY PHONE - CALL 01544 327 111

Our opening hours are:

- Monday - Friday: 9.00am - 5.00pm
- Saturday: 9.00am - 3.00pm
- Sunday: Closed

Outside of these hours we have an answerphone facility where you can leave a message and we will get back to you as soon as possible.

VAT Charges: For orders delivered to the UK or European Union VAT is included at the current rate of 20%. For all Non-UK and Non-EU deliveries VAT will be deducted.

UK POSTAGE & PACKAGING PRICES

ANY ORDER OVER £50 DELIVERED TO UK ADDRESS	FREE
Small Items Flies, Leaders and Light Fly Tying	£1.99
Medium Items Tippet, Reels, Lines, Fly boxes, Clothing, Vices etc	£3.99
Large/Heavy Items Rods, Waders, Bags, Nets etc.	£5.99
Next Working Day Delivery (Monday to Friday)	£8.99

Available for UK mainland addresses only.
Order before 15:00, delivery next working day.
No deliveries on weekends or Bank holidays.

OVERSEAS ORDERS

Postage is charged at cost on overseas orders. Exact quotations are available. VAT exemption for non EEC countries and VAT registered EEC customers.

CONTACT US

Sportfish is dedicated to your satisfaction. We welcome your suggestions and comments. Our contact details follow:

By Email: orders@sportfish.co.uk

By Post: Sportfish, Winforton, Hereford, Herefordshire HR3 6SP, United Kingdom

By Phone: 01544 327111 (International +44 1544 327111)
(Calls may be recorded for training purposes).

Our VAT Registration Number 762446520

Proud To Support:



WILD TROUT TRUST



Our catalogue is printed using FSC® (Forest Stewardship Council®) certified paper and is mailed out in a recyclable FSC® certified wrap.

Reducing Our Carbon Footprint:



A

Accessories and Tools 151-160, 186-188

B

Backing Lines 71
 Backpacks 103, 166, 169-173
 Bags 2-3, 123, 155, 157, 160, 166-175, 184, 219
 Base Layers 126, 136-137
 Bass Bags 155
 Beads 194
 Belts - Wading 123
 Bibs 129-130
 Boat Accessories 160
 Boat Seats 161
 Books 203-204
 Boots 111-114, 118-119
 Braided Loops 71
 Braided Spinning Lines 215-216
 Buff 150

C

C&F Tools 188
 Capes (Fly Tying) 200
 Caps 149-150
 Chenille 198
 Children 2-5, 117, 146, 161, 207
 Classic Bags 171
 Clippers 152
 Clothing 124-150
 Cocoon Sunglasses 179
 Cool Bags 155, 158
 Copolymer Tippet & Leaders 74-76

D

Drogues 160
 Dubbing 197
 Dubbing Boxes 197
 DVD's 204

E

Euro Nymphing 30
 Eyes (Fly-Tying) 195
 Eyewear 176-180
 Eyewear Accessories 180

F

Feathers 201
 Filleting 155-156
 First Aid Kits 155
 Fish Carriers 155
 Fish Tube 155
 Fishing Vests 145-147
 Fitover Sunglasses 179
 Flasks 157-158
 Flats Boots 119
 Flats Shirts 138, 140-141, 143
 Fleece Pants 126, 136-137
 Fleece Tops 126, 136-137
 Flies 79-94
 Float Tubes 160
 Floatants 151
 Fluorocarbon 72-73, 75-76
 Fly Boxes 95-100
 Fly Driers 154
 Fly Hooks 190-193
 Fly Line Accessories 68, 69
 Fly Line Treatments 70
 Fly Lines 55-67
 Fly Lines - Floating 55-58
 Fly Lines - Intermediate 59
 Fly Lines - Salmon 63-67
 Fly Lines - Saltwater 63
 Fly Lines - Shooting Heads 66-67
 Fly Lines - Sink Tip 60
 Fly Lines - Sinking 60-61
 Fly Lines - Skagit 66
 Fly Lines - Spey 65
 Fly Lines - Switch 64
 Fly Patches 100, 154
 Fly Reel Cases 53
 Fly Reels 35-52
 Fly Rods 4-5, 8-33
 Fly Sets 92-94
 Fly Threaders 99
 Fly Tying Kits 185
 Fly Tying Materials 185, 193-202
 Fly Tying Resin 189
 Fly Tying Tools 159, 182-189
 Fly Tying Tubes 194-195
 Fly Tying Vices 182-184
 Fly Wallets 99
 Forceps 153
 French Nymphing 30

G

Game Fishing Centre 222
 Gear Bags 157, 166-175
 Gift Vouchers 159
 Gifts 159
 Gink 151
 Gloves 148
 Glues 70, 78
 Gravel Guards 119, 122
 Greeting Cards 159

H

Hair & Fur 200-202
 Handwarmers 159
 Hats 149-150
 Head Torches 156
 Hooks 190-193
 Hoodies 135, 136, 138, 141, 143

I

Indicators 151
 Indoor Practice Rods 32
 Insect Repellent 150

J

Jackets 124-125, 127-134

K

Ketchum Release Tools 154
 Kettles 156
 Knot Tools 154

L

Laces 121
 Lamps (Fly-Tying) 185
 Lanyards 100, 153
 Layering 124-126, 131, 134, 136-137

Leader Rings 78
 Leader Storage 78
 Leaders - Copolymer 75-76
 Leaders - Fluorocarbon 75-76
 Leaders - Nylon 74, 77
 Leaders - Saltwater 76-77
 Leaders - Woven 71
 Leaders & Tippets 72-78
 Life Jackets 161
 Line Trays 160
 Line Winders 70
 Lines - Spinning 215-216
 Long Sleeve T-Shirts 141
 Lures - Spinning 211-215

M

Magnifying Glasses 176-180
 Maps - Salmon Rivers 159
 Marrow Spoons 155
 Midge Nets 150
 Mugs 158-159

N

Net Holders 165
 Net Slings 162
 Nets 162-165
 Nippers 152
 Nylon - Spinning 216

P

Pike Outfits 31
 Pliers 153, 218
 Predatory Fishing 31
 Priests 155

R

Reading Store 222
 Ready to Fish Kits 4-5, 10, 30-31, 207
 Reel Cases 53
 Reels - Fly Reels 35-52
 Reels - Spinning 208-210
 Replacement Soles 121
 Resin & Lights 189
 Retractors 122, 152, 165
 Rod Care 32
 Rod Carriers 32
 Rod Cases 33
 Rod Tubes 33
 Rods - Fly Rods 4-5, 8-31
 Rods - Spinning 205-207
 Rubber Tails 214

S

Safety Jackets 161
 Scales 154
 Scissors 153, 187-188
 Sharpeners 156
 Shirts 126, 138-140, 143
 Shooting Head Accessories 68
 Sinkants 151
 Smokers 156
 Snips 152
 Social Media 221
 Socks 119-120, 122
 Spinner Boxes 218-219
 Spinners 211-215
 Spinning Accessories 216-218
 Spinning Line 215-216
 Spinning Reels 208-210
 Spinning Rods 205-207
 Spinning Tools 218
 Spool Tenders 53
 Strike Indicators 151
 Studs 112, 114
 Sun Cream 150
 Sun Hats 149-150
 Sunglasses 176-180
 Sunglasses Accessories 180
 Superglues 70, 78
 Switch Lines 64
 Swivels 217

T

Tackle Bags 166-175
 Tackle Boxes 218-219
 Thermometers 154
 Threaders 78, 99
 Threads 196
 Tinsels 196
 Tippet - Copolymer 74
 Tippet - Fluorocarbon 72-73
 Tippet Dispensers 78
 Tool Sets 153, 159, 183, 186-187
 156
 Torches (Head) 126, 138-144, 148-149
 Tropical Clothing 120
 Tropical Wading Boots 126, 129, 130-131, 138, 144
 Trousers 142
 T-Shirts 184
 Tube Fly Attachments 194-195
 Tubes - Fly Tying 222
 Tuition & Courses

V

Varnish 189
 Vests 145 - 147
 Vices 182 - 184

W

Wader Bags 123
 Wader Boot Bags 123
 Wader Repair 121
 Waders 103-110, 115-117
 Waders - Bootfoot Chest Waders 116-117
 Waders - Deals 104-105, 115
 Waders - Stockingfoot Chest Waders 103, 110, 115
 Waders - Thigh Waders 109, 117
 Wading - Under Wader Layers 126, 131, 136-137
 Wading Accessories 121-123
 Wading Belts 123
 Wading Boots 111-114
 Wading Jackets 124, 127, 131-133
 Wading Safety 161
 Wading Socks 119-120
 Wading Staffs 122
 Waistcoats 145-147
 Waterproof Bags 157, 166-175
 Waterproof Bibs 129-130, 133
 Waterproof Jackets 124, 127-133
 Waterproof Trousers 129-130
 Waterproofing Treatments 121
 Waxes (Fly-Tying) 189
 Weather Protection Hats 149-150
 Weighing Scales 154
 Wellington Boots 118
 Wheeled Luggage 174-175
 Winforton Store 220
 Wire Traces and Leaders 78, 216
 Wires (Fly-Tying) 196
 Womens 115, 128
 Wrist Supports 157

Y

Yeti 158

Z

Zingers 152

WE'RE PROUD TO SUPPORT:



PUTTING WILD SALMON FIRST

Wild Atlantic salmon could disappear altogether from our rivers in 30 years. The Atlantic Salmon Trust uses scientific research to understand their decline, and puts evidence-based solutions into practice.



WILD TROUT TRUST

INSPIRING EVERYONE TO PROTECT WILD TROUT AND THEIR HABITAT

WTT experts work with landowners, local communities, fishing clubs, rivers trusts and government agencies providing practical advice and hands-on habitat improvement projects.



HELP PROTECT FISH, FISHING AND THE ENVIRONMENT

A not for profit member-based organisation made up of anglers of all disciplines providing a united front to represent, grow and protect the sport.



BY THOSE WHO FISH.
FOR THOSE WHO FISH.



PlanetMark
Certified Business